



U.S. Department  
of Transportation  
Federal Aviation  
Administration

# Aviation Environmental Design Tool (AEDT)

Version 3g

Technical Manual

August 2024



# REPORT DOCUMENTATION PAGE

Form Approved  
OMB No. 0704-0188

Public reporting burden for this collection of information is estimated to average 1 hour per response, including the time for reviewing instructions, searching existing data sources, gathering and maintaining the data needed, and completing and reviewing the collection of information. Send comments regarding this burden estimate or any other aspect of this collection of information, including suggestions for reducing this burden, to Washington Headquarters Services, Directorate for Information Operations and Reports, 1215 Jefferson Davis Highway, Suite 1204, Arlington, VA 22202-4302, and to the Office of Management and Budget, Paperwork Reduction Project (0704-0188), Washington, DC 20503.

1. AGENCY USE ONLY (Leave blank)

2. REPORT DATE  
August-2024

3. REPORT TYPE AND DATES COVERED  
8/2024

4. TITLE AND SUBTITLE

Aviation Environmental Design Tool (AEDT)  
Technical Manual, Version 3g

5a. FUNDING NUMBERS  
FC14C924

6. AUTHOR(S)

U.S. DOT Volpe Center:

Ross, Jason  
Ahearn, Meghan  
Boeker, Eric  
Cumper, Jordan  
Downs, Robert  
Goetzinger, Steve  
Gorshkov, Slava  
Hansen, Andrew  
Malwitz, Andrew  
Mittelman, Anjuliee  
Nicholas, Bradley  
Reherman, Clay  
Simon, Matthew  
Tosa, Yasunari  
Wilson, Andrew

FAA:

DiPardo, Joseph  
Majeed, Mohammed

Acrotron:

Hwang, Sunje  
Kuiper, Bjorn

ATAC Corp:

Bernal, Jose  
Biederman, Andrew  
Dinges, Eric  
Rickel, Denise  
Yaworski, Michael

CSSI, Inc.:

Hall, Clifford

RoVolus:

Augustine, Stephen

Metron Aviation:

Foley, Ryan

Previous Authors

Lee, Cynthia  
Koopmann, Jonathan  
Noel, George  
Senzig, David  
Solman, Gina Barberio  
Thrasher, Theodore  
Zubrow, Alexis

5b. CONTRACT NUMBER  
AAR374

7. PERFORMING ORGANIZATION NAME(S) AND ADDRESS(ES)

U.S. Department of Transportation  
Volpe National Transportation Systems Center  
220 Binney Street  
Cambridge, MA 02142

8. PERFORMING ORGANIZATION REPORT  
NUMBER  
DOT-VNTSC-FAA-24-08

9. SPONSORING/MONITORING AGENCY NAME(S) AND ADDRESS(ES)

U.S. Department of Transportation  
Federal Aviation Administration  
Office of Environment and Energy (AEE-100)  
800 Independence Ave. SW  
Washington, DC 20591

10. SPONSORING/MONITORING  
AGENCY REPORT NUMBER

11. SUPPLEMENTARY NOTES

FAA Program Managers: Joseph DiPardo, Mohammed Majeed

12a. DISTRIBUTION/AVAILABILITY STATEMENT

This report is part of the AEDT 3g software release, and it is publicly available.

12b. DISTRIBUTION CODE

13. ABSTRACT (Maximum 200 words)

The Federal Aviation Administration, Office of Environment and Energy (FAA-AEE) has developed the Aviation Environmental Design Tool (AEDT) version 3g software system with the support of the following developers, listed as they were known at the time of contribution: FAA, National Aeronautics and Space Administration (NASA), U.S. DOT Volpe National Transportation Systems Center (Volpe Center), Acrotron, ATAC Corporation, Metron Aviation, Wyle Laboratories, CSSI, Inc., Foliage, Altran, Senzig Engineering, RoVolus, MIT, and Georgia Tech. AEDT 3g models aircraft performance in space and time to estimate fuel consumption, emissions, noise, and air quality consequences. AEDT is designed to process individual studies ranging in scope from a single flight at an airport to scenarios at the regional, national, and global levels. This Technical Manual describes the technical methodologies in AEDT 3g.

14. SUBJECT TERMS

aircraft acoustics, aircraft emissions, aircraft performance, FAA, AEDT, air traffic, airspace, noise contours, impact evaluation, change analysis, environmental impact statement, environmental assessment, air quality, emissions dispersion, environmental justice

15. NUMBER OF PAGES  
521

16. PRICE CODE

17. SECURITY CLASSIFICATION  
OF REPORT  
Unclassified

18. SECURITY CLASSIFICATION  
OF THIS PAGE  
Unclassified

19. SECURITY CLASSIFICATION  
OF ABSTRACT  
Unclassified

20. LIMITATION OF ABSTRACT  
UU

## PREFACE

This document is the Technical Manual for the Federal Aviation Administration (FAA) Office of Environment and Energy (AEE) Aviation Environmental Design Tool Version 3g (AEDT 3g) computer software, which is designed to compute noise, fuel consumption, emissions, and air quality consequences.

The U.S. Department of Transportation (USDOT) Volpe National Transportation Systems Center (Volpe Center), the ATAC Corporation, JDR, Senzig Engineering, Metron Aviation, CSSI, Inc., and the FAA AEE have jointly prepared this document.

This Technical Manual does not contain guidance or policy for regulatory analyses. Guidance documents as well as additional documentation such as the AEDT User Manual, AEDT Supplemental Manual: ASIF Reference, and detailed information on select features can be found on the FAA Office of Environment and Energy (AEE) website ([https://www.faa.gov/about/office\\_org/headquarters\\_offices/apl/aee](https://www.faa.gov/about/office_org/headquarters_offices/apl/aee)) and also available on the AEDT Support website (<https://aedt.faa.gov/>).

## DISCLAIMER

The contents do not necessarily reflect the official views or policy of the USDOT or the Federal Aviation Administration. This AEDT Technical Manual does not constitute a standard, specification, or regulation.

*AEDT uses data and methods from the EUROCONTROL Base of Aircraft Data (BADA). BADA is a tool owned by EUROCONTROL ©2024. All rights reserved.*

*Users of AEDT must follow the terms and conditions of their BADA license agreement with EUROCONTROL.*

*BADA is provided on a strict "AS IS" basis, without any warranty of any kind either express or implied including but not limited to the implied warranties of merchantability, fitness for a particular purpose, title and non-infringement.*

*Neither EUROCONTROL nor any third party (in particular aircraft manufacturers) warrant that BADA will be error-free or that such errors will be corrected. The BADA licensee is solely responsible for all costs and expenses associated with rectification, repair, or damage caused by such errors.*

*Neither EUROCONTROL nor any third party (in particular aircraft manufacturers) shall be liable to the BADA licensee or to any other party for any loss or damage whatsoever or howsoever arising directly or indirectly in connection with BADA or its use.*

## Table of Contents

PREFACE.....	I
DISCLAIMER.....	I
LIST OF TABLES.....	X
LIST OF FIGURES.....	XV
1. INTRODUCTION.....	1
1.1 OVERVIEW.....	1
1.2 SYSTEM ARCHITECTURE.....	1
1.3 ABOUT THIS TECHNICAL MANUAL.....	2
1.4 TERMINOLOGY.....	4
1.5 ABBREVIATIONS.....	17
2. DATA.....	20
2.1 AEDT DATABASES.....	20
2.1.1 <i>Overview</i> .....	20
2.1.2 <i>Study Database</i> .....	20
2.1.3 <i>Airport Database</i> .....	21
2.1.4 <i>Fleet Database</i> .....	22
2.1.5 <i>Equipment Operations (Study)</i> .....	22
2.2 INPUT DATA.....	24
2.2.1 <i>Summary of Input Data for Noise Computation</i> .....	24
2.2.2 <i>Summary of Input Data for Emissions Inventory Computation</i> .....	35
2.2.3 <i>External Data</i> .....	47
3. AIRCRAFT PERFORMANCE.....	57
3.1 TRAJECTORIES.....	57
3.1.1 <i>Properties</i> .....	57
3.1.2 <i>Targets</i> .....	58
3.2 FLIGHT PERFORMANCE MODELS.....	59
3.3 WEATHER MODEL.....	60
3.3.1 <i>ISA Weather Model</i> .....	61
3.3.2 <i>Airport Average Atmospheric Models</i> .....	62
3.3.3 <i>High-Fidelity Weather Model</i> .....	65
3.4 FUEL CONSUMPTION MODELS.....	65
3.4.1 <i>Fixed-Wing BADA 3 Fuel Consumption</i> .....	65
3.4.2 <i>Fixed-Wing Senzig-Fleming-Iovinelli Fuel Consumption - Turbofan engine</i> .....	68

3.4.3	<i>BFFM2 Fixed-Wing Fuel Consumption</i> .....	68
3.4.4	<i>Helicopter Fuel Consumption</i> .....	70
3.5	GROUND TRACK .....	70
3.5.1	<i>Ground Track Definition and Computation</i> .....	70
3.5.2	<i>Points from Vectors</i> .....	75
3.5.3	<i>Radius of Curvature</i> .....	76
3.6	DOC 9911 - BADA 3 ANALYSIS OF PROFILE-DRIVEN FLIGHT PERFORMANCE .....	77
3.6.1	<i>Local Weather</i> .....	77
3.6.2	<i>Airplane Profile Calculation</i> .....	77
3.6.3	<i>Helicopter Profile</i> .....	106
3.6.4	<i>Flight Path Calculation</i> .....	109
3.6.5	<i>Bank Angle Treatment</i> .....	111
3.7	DOC 9911 - BADA 4 ANALYSIS OF PROFILE-DRIVEN FLIGHT PERFORMANCE .....	115
3.7.1	<i>Overview</i> .....	115
3.7.2	<i>Aircraft Types</i> .....	115
3.7.3	<i>Aerodynamic Configuration Selection</i> .....	116
3.7.4	<i>Speed Conversions</i> .....	117
3.7.5	<i>Input Track Modeling</i> .....	118
3.7.6	<i>Procedure Step Components</i> .....	119
3.7.7	<i>Behavior Above 10K MSL</i> .....	132
3.7.8	<i>Thrust</i> .....	135
3.7.9	<i>Drag</i> .....	139
3.7.10	<i>Fuel Flow</i> .....	140
3.7.11	<i>Noise Operation Mode</i> .....	142
3.8	DIFFERENCES BETWEEN DOC 9911 AND BADA 4 ANALYSIS OF TERMINAL-AREA PROCEDURES .....	143
3.8.1	<i>Physics Models</i> .....	143
3.8.2	<i>Fuel Burn Models</i> .....	144
3.8.3	<i>General Differences in Implementation of Procedure Step Modeling</i> .....	145
3.8.4	<i>Aircraft Banking Effects</i> .....	146
3.8.5	<i>Calibrated Airspeed &amp; Altitude-Based Segmentation</i> .....	146
3.8.6	<i>Doc 9911 Thrust Transitions</i> .....	147
3.8.7	<i>Aircraft Weight in Procedure Profile Computations</i> .....	148
3.8.8	<i>Projected vs. Geographic Coordinate System</i> .....	148
3.8.9	<i>Speed Conversions</i> .....	148
3.8.10	<i>Wind Direction Aligned with Runway</i> .....	149
3.8.11	<i>Initial Departure Takeoff Thrust</i> .....	149
3.8.12	<i>Takeoff Ground Roll Step Splitting</i> .....	150

3.8.13	Thrust Tapering.....	150
3.8.14	User-Specified Thrust.....	150
3.9	TRAJECTORY-DRIVEN FLIGHT PERFORMANCE.....	150
3.9.1	Track Control Flights.....	150
3.9.2	Sensor Path Flights.....	175
3.10	NOISE MODE.....	182
3.11	INSERTION AT SIGNIFICANT ALTITUDES.....	185
3.11.1	Noise Cutoff Altitude.....	185
3.11.2	Mixing Height.....	185
3.11.3	Altitude Intervals.....	186
3.12	USE CASE OF TRACK ALTITUDE CONTROL AT 18,000 FT MSL.....	186
4.	NOISE.....	187
4.1	FLIGHT PATH SEGMENT PARAMETERS.....	187
4.1.1	Closest Point of Approach and Slant Range.....	190
4.1.2	Speed, Altitude, Distance, and Power.....	191
4.2	NOISE-POWER-DISTANCE (NPD) DATA COMPUTATIONS.....	193
4.2.1	Noise Metric Approximations.....	193
4.2.2	Noise Level Interpolation/Extrapolation ( $L_{P,D}$ ).....	194
4.3	GENERAL AEDT NOISE ADJUSTMENTS.....	197
4.3.1	Atmospheric Absorption Adjustment ( $AA_{ADJ}$ ).....	197
4.3.2	Acoustic Impedance Adjustment ( $AI_{ADJ}$ ).....	198
4.3.3	Noise Fraction Adjustment for Exposure Metrics ( $NF_{ADJ}$ ).....	199
4.3.4	Duration Adjustment for Exposure-Based Metrics ( $DUR_{ADJ}$ ).....	201
4.3.5	Lateral Attenuation Adjustment ( $LA_{ADJ}$ ).....	202
4.3.6	Line-of-Sight Blockage Adjustment ( $LOS_{ADJ}$ ).....	211
4.4	FIXED-WING AIRCRAFT ADJUSTMENTS.....	213
4.4.1	Thrust Reverser Adjustment ( $TR_{ADJ}$ ).....	213
4.4.2	Ground-Based Directivity Adjustment ( $DIR_{ADJ}$ ).....	216
4.4.3	Number of Engines Adjustment ( $NE_{ADJ}$ ).....	219
4.5	HELICOPTER ADJUSTMENTS.....	219
4.5.1	Source Noise Adjustment Due to Advancing Tip Mach Number ( $MN_{ADJ}$ , Level Flyover only).....	219
4.5.2	Lateral Directivity Adjustment ( $LD_{ADJ}$ ).....	220
4.5.3	Static Directivity Adjustment ( $DIR_{HELI\_ADJ}$ ).....	222
4.5.4	Static Operation Duration Adjustment ( $t_{HELI\_static}$ ).....	222
4.6	NOISE COMPUTATION.....	223

4.6.1	<i>System Adjustments</i> .....	226
4.6.2	<i>Computation of Exposure-Based Noise Level Metrics</i> .....	226
4.6.3	<i>Computation of Maximum Noise Level Metrics</i> .....	229
4.6.4	<i>Computation of Time-Based Metrics</i> .....	232
4.6.5	<i>Accumulation of Noise Metric Computations</i> .....	236
4.7	DYNAMIC GRID PROCESS .....	246
4.8	NOISE COMBINATION .....	248
4.8.1	<i>Overview</i> .....	248
4.8.2	<i>Receptor Location Projection</i> .....	249
4.8.3	<i>Acoustics Values at Receptors (Scaling)</i> .....	249
4.8.4	<i>Delaunay Triangulation</i> .....	250
4.8.5	<i>Triangulation Algorithm</i> .....	251
4.8.6	<i>Interpolation</i> .....	258
4.8.7	<i>Combination</i> .....	261
5.	EMISSIONS INVENTORY .....	267
5.1	AIRCRAFT EMISSIONS.....	267
5.1.1	<i>Airborne Emissions</i> .....	267
5.1.2	<i>Taxi Emissions</i> .....	276
5.1.3	<i>Startup Emissions</i> .....	277
5.1.4	<i>Auxiliary Power Units Emissions</i> .....	278
5.2	GROUND SUPPORT EQUIPMENT (GSE) .....	279
5.2.1	<i>GSE Population Processing Algorithm</i> .....	279
5.2.2	<i>Aircraft-Assigned GSE Processing Algorithm</i> .....	281
5.2.3	<i>GSE Data Sources</i> .....	282
5.3	STATIONARY SOURCES .....	289
5.4	SPECIATED ORGANIC GAS (SOG) EMISSIONS .....	291
5.4.1	<i>Aircraft</i> .....	291
5.4.2	<i>Non-Aircraft</i> .....	291
5.4.3	<i>Calculation of SOG Emissions</i> .....	293
5.4.4	<i>How SOG Is Calculated as Post-Processing</i> .....	293
6.	EMISSIONS DISPERSION.....	295
6.1	AERMOD EMISSIONS SOURCES.....	295
6.1.1	<i>AERMOD Source Groups</i> .....	296
6.2	AEDT MAP PROJECTION .....	298
6.3	EMISSIONS FROM AIRBORNE AND GROUND ROLL FLIGHT SEGMENTS.....	298
6.3.1	<i>Three-Dimensional Voxel Grid</i> .....	299

6.3.2	<i>Two-Dimensional Voxel Grid</i> .....	300
6.3.3	<i>Voxel Grids Aligned with a Runway</i> .....	300
6.3.4	<i>Allocating Emissions from Flight Segments</i> .....	302
6.4	EMISSIONS FROM RUNUP OPERATIONS .....	305
6.5	EMISSIONS FROM TAXI SEGMENTS.....	305
6.6	EMISSIONS FROM GATES AND TERMINALS .....	306
6.7	EMISSIONS FROM STATIONARY SOURCES .....	309
6.8	EMISSIONS FROM ROADWAYS, PARKING FACILITIES, AND CONSTRUCTION SOURCES.....	312
6.9	APPLYING BACKGROUND CONCENTRATIONS.....	312
6.9.1	<i>Hourly Background Concentrations File</i> .....	313
6.9.2	<i>Non-Hourly Background Concentrations File</i> .....	313
6.9.3	<i>Outputs of Background Concentrations</i> .....	314
6.10	NO <sub>2</sub> DISPERSION MODELING.....	315
6.10.1	<i>Tier 1</i> .....	315
6.10.2	<i>Tier 2 (ARM2)</i> .....	315
6.10.3	<i>Tier 3 (OLM and PVMRM), Non-Regulatory ALPHA (TTRM/TTRM2), and BETA (GRSM) Options</i> .....	315
6.11	NON-NAAQS PM <sub>2.5</sub> DISPERSION OPTION .....	320
6.12	URBAN MODELING OPTION .....	321
6.13	LOW WIND OPTIONS (ALPHA).....	322
6.14	PLUME RISE FOR AIRCRAFT SOURCES OPTION (ALPHA) .....	322
6.15	AREA MEANDER OPTION (ALPHA) .....	322
6.16	AERMET WEATHER PROCESSING .....	322
6.16.1	<i>Overview</i> .....	322
6.16.2	<i>Accepted Weather Data Formats</i> .....	324
6.16.3	<i>Modeling Low Wind Speed/Stable Conditions</i> .....	325
6.16.4	<i>Use of AERMINUTE</i> .....	326
6.16.5	<i>AERSURFACE Integration with AEDT</i> .....	327
6.17	TERRAIN PROCESSING .....	328
6.18	GENERATING HOURLY EMISSIONS FILES.....	328
6.19	GENERATING AERMOD INPUT FILES (.INP AND .HRE).....	329
6.20	RUNNING AERMOD .....	329
6.20.1	<i>Emissions Dispersion Output Options</i> .....	330
6.20.2	<i>Exclusion Zones with Volume Sources</i> .....	331
7.	GROUND OPERATIONS .....	332



7.1	OPERATING CONFIGURATIONS .....	332
7.2	CONFIGURATION ACTIVATION BASED ON ACTIVATION PARAMETERS .....	332
7.3	TAXIWAY NETWORKS .....	335
7.3.1	<i>Taxi Network Elements and Terminology</i> .....	335
7.3.2	<i>Taxi Network Algorithm Overview</i> .....	337
7.4	AIR OPERATION SCHEDULING .....	360
7.4.1	<i>Pseudorandom Number Generation</i> .....	360
7.4.2	<i>Pseudo-schedule Generation</i> .....	361
7.4.3	<i>Schedule Generation</i> .....	362
7.5	DELAY MODEL .....	364
7.6	SEQUENCING MODEL .....	367
7.6.1	<i>Sequencing Algorithm and Outputs</i> .....	371
8.	ANNUALIZATION .....	373
8.1	OVERVIEW .....	373
8.2	PEAK MONTH AVERAGE DAY AND ANNUAL AVERAGE DAY ANNUALIZATIONS .....	377
8.2.1	<i>Annual Average Day and Design Day Ratio Calculation Example</i> .....	378
9.	CHANGE ANALYSIS AND IMPACT EVALUATION .....	380
9.1	CHANGE ANALYSIS .....	380
9.1.1	<i>Change Analysis Report Statistics</i> .....	380
9.2	IMPACT EVALUATION .....	382
10.	ENVIRONMENTAL JUSTICE CAPABILITY .....	383
10.1	OVERVIEW .....	383
10.2	AMERICAN COMMUNITY SURVEY (ACS) DATA .....	383
10.2.1	<i>Environmental Justice (EJ)</i> .....	383
10.2.2	<i>Limited English Proficiency (LEP)</i> .....	386
10.3	ENVIRONMENTAL JUSTICE DEMOGRAPHIC VARIABLES .....	387
10.4	LIMITED ENGLISH PROFICIENCY DEMOGRAPHIC VARIABLES .....	389
10.4.1	<i>Backwards Compatibility for ACS 2015 Data</i> .....	390
11.	APPENDIX – NOISE .....	392
11.1	NOISE ADJUSTMENT AND METRIC DERIVATIONS .....	392
11.1.1	<i>Derivation of the Acoustic Impedance Adjustment</i> .....	392
11.1.2	<i>Derivation of the Noise Exposure Fraction Adjustment</i> .....	395
11.1.3	<i>Derivation of the Time-Above Equation</i> .....	400
11.1.4	<i>Recalculation of NPD Data for Non-Reference Conditions</i> .....	401
11.1.5	<i>Calculating Audibility</i> .....	410

11.2	ACOUSTIC DATA DEVELOPMENT.....	415
11.2.1	<i>Acoustic Data Development Criteria</i> .....	415
11.2.2	<i>Overview of Spectral Class Development</i> .....	416
11.2.3	<i>Performance and Acoustics</i> .....	424
11.3	AIRCRAFT NOISE AND PERFORMANCE DATA VERIFICATION AND VALIDATION .....	465
11.3.1	<i>NPD and Spectral Data Verification and Validation</i> .....	466
11.3.2	<i>Spectral Class Assignments</i> .....	467
11.3.3	<i>Performance Data Verification and Validation</i> .....	470
11.3.4	<i>Model Comparison of Submitted Data with Certification Data</i> .....	471
12.	APPENDIX – BADA 4 MODEL.....	472
12.1	INTRODUCTION .....	472
12.1.1	<i>History of BADA 3</i> .....	472
12.1.2	<i>Why BADA 4 Is Necessary</i> .....	472
12.1.3	<i>BADA 4 Data Restrictions</i> .....	472
12.2	FAA’S INTEREST IN BADA 4.....	472
12.2.1	<i>ANP Limitations for Environmental Modeling</i> .....	472
12.2.2	<i>Speed- and Configuration-Dependent Noise</i> .....	473
12.3	BADA 4 OVERVIEW .....	474
12.3.1	<i>Total Energy Model Overview</i> .....	474
12.3.2	<i>BADA 4 Components</i> .....	474
13.	APPENDIX – EMISSIONS DISPERSION .....	476
13.1	CONSTRUCTING AERMOD RECTANGLE SOURCES FROM A LINE SEGMENT .....	476
13.2	EMISSIONS FACTOR CALCULATION FOR STATIONARY SOURCES AND TRAINING FIRES .....	477
13.2.1	<i>Data Sources</i> .....	477
13.2.2	<i>Other Category</i> .....	477
13.2.3	<i>Boilers and Space Heaters</i> .....	478
13.2.4	<i>Emergency Generators</i> .....	480
13.2.5	<i>Incinerators</i> .....	480
13.2.6	<i>Aircraft Engine Testing</i> .....	481
13.2.7	<i>Fuel Tanks</i> .....	482
13.2.8	<i>Surface Coating</i> .....	483
13.2.9	<i>Deicing</i> .....	484
13.2.10	<i>Solvent Degreasers</i> .....	484
13.2.11	<i>Particulate Piles</i> .....	485
13.2.12	<i>Training Fires</i> .....	485

13.3 PLUME RISE MODELING OPTION .....486

    13.3.1 *Plume Rise Variables in the AERMOD Hourly Emissions Rate File* .....486

    13.3.2 *AERMOD.INP File Changes in Support of Plume Rise Modeling*.....490

14. APPENDIX – EXAMPLE OF GSE POPULATION EMISSIONS CALCULATION .....494

15. APPENDIX – MAP PROJECTION METHOD .....497

16. REFERENCES .....499

## LIST OF TABLES

Table 1-1 Definition of One-Third Octave-Bands.....	12
Table 2-1 Engine Power Setting Units.....	25
Table 2-2 Operational Mode for Each Fixed-Wing Aircraft NPD Data Set.....	26
Table 2-3 Operational Mode Procedure Steps for Each Helicopter NPD Data Set.....	26
Table 2-4 Substitution Operational Mode Procedure Steps Data for Helicopters, including the Appropriate Helicopter Operational Mode Adjustment .....	30
Table 2-5 Summary of AEDT Noise Metric Abbreviations and Definitions.....	32
Table 2-6 Input Data for APU.....	38
Table 2-7 Input Data for Aircraft-Assigned GSE.....	39
Table 2-8 Input Data for GSE Population .....	39
Table 2-9 Input Data for Boilers and Space Heaters.....	40
Table 2-10 Input Data for Emergency Generator (EPA Methodology).....	41
Table 2-11 Input Data for Emergency Generators (USAF Methodology) .....	42
Table 2-12 Input Data for Incinerator .....	43
Table 2-13 Input Data for Aircraft Engine Testing .....	43
Table 2-14 Input Data for Fuel Tank .....	44
Table 2-15 Input Data for Surface Coating/Painting.....	44
Table 2-16 Input Data for Deicing Area .....	45
Table 2-17 Input Data for Solvent Degreaser .....	45
Table 2-18 Input Data for Sand/Salt Pile.....	45
Table 2-19 Input Data for Training Fire.....	46
Table 2-20 Input Data for “Other” Stationary Sources .....	46
Table 2-21 Weather Data Formats Supported.....	47
Table 3-1 Properties and Units of Instantaneous States .....	57
Table 3-2 Properties and Units of Segments .....	58
Table 3-3 Thrust Reduction Schedule .....	83
Table 3-4 Thrust Types for Reduced Thrust Setting.....	83
Table 3-5 Profile Naming Convention.....	86
Table 3-6 ANP-to-BADA 4 Configuration Map for an AEDT Airplane Composed of an A320-211 ANP Airplane and an A320-212 BADA 4 Airplane.....	116
Table 3-7 ICAO Doc 9911-Specified Initial Climb Procedure Step Segmentation Altitudes .....	121
Table 3-8 Summary of the Thrust Model Used to Calculate Fuel Flow/Burn for Each Procedure Step Type in BADA 4 Workflows.....	141
Table 3-9 Summary of the Thrust Model Used to Calculate BADA 4 Fuel Flow/Burn for Non-Procedure- Step for Profile-Driven Operations .....	142
Table 3-10 Default Noise Operation Mode Assignments During Procedure Profile Computations.....	142
Table 3-11 Style of Segmentation for Each Procedure Step Type (or Above-Step Type Behavior) in the BADA 4 Analysis of Procedure Profiles .....	147

Table 4-1 Position of the Receptor Relative to the Flight Path Segment .....	190
Table 4-2 AEDT Noise Metric-Specific Weighting and Averaging Factors .....	238
Table 4-3 Example Input Points .....	251
Table 5-1 Adjustment Factors for Installation Effects .....	269
Table 5-2 Default Constant PM EI Values above the Mixing Height.....	271
Table 5-3 Constant CO <sub>2</sub> and H <sub>2</sub> O EI Values .....	272
Table 5-4 Pollutant Conversion Factors for Turbine Engines.....	274
Table 5-5 Pollutant Conversion Factors for Piston Engines .....	275
Table 5-6 Aircraft Size by Maximum APU Fuel Flow Rate.....	279
Table 5-7 Fuel Sulfur Content by Year and Fuel Type from MOVES4 .....	283
Table 5-8 Summary of GSE Mappings to SCCs and Regulatory Class IDs within EPA’s MOVES4 Model by GSE Type and GSE Fuel Type.....	284
Table 5-9 Sulfur-to-Sulfate Conversion Rates for GSE .....	288
Table 5-10 Factors for Calculating NMHC, VOC, and TOG, Based on GSE Fuel Type.....	289
Table 5-11 Units for Stationary Sources & Training Fires .....	290
Table 6-1 Source Groups in AEDT and AERMOD .....	296
Table 6-2 ICAO Standard LTO Cycle and Thrust Settings .....	318
Table 6-3 Accepted Weather Data Formats for Emissions Dispersion Modeling.....	324
Table 7-1 Assumed Extreme Values for Configuration Activation Parameters .....	333
Table 7-2 Reassigned Values of Projected Point pn.....	343
Table 7-3 Taxiway-Taxiway Intersections Calculated for the Taxi Network Shown in Figure 7-9 and Figure 7-10 .....	349
Table 7-4 Taxiway-Runway Intersections Calculated for the Taxi Network Shown in Figure 7-9 and Figure 7-10 .....	349
Table 7-5 Taxiway-Gate Intersections Calculated for the Taxi Network Shown in Figure 7-9 and Figure 7-10 .....	350
Table 7-6 Insert Points for Each Taxiway in the Taxi Network Shown in Figure 7-9 and Figure 7-10 .....	350
Table 7-7 Identical Points for Each Taxiway in the Taxi Network Shown in Figure 7-9 and Figure 7-10..	350
Table 7-8 Taxiway Indices for the new definition of the example taxipath; so far, only switches from one taxiway to the next are conveyed in the new taxipath definition. ....	351
Table 7-9 Taxiway Indices for the new definition of the example taxipath; so far, the definition contains the switch from the gate to the first taxiway and switches from one taxiway to the next. ....	352
Table 7-10 Taxiway Indices for the new definition of the example taxipath; so far, the definition contains the switch from the gate to the first taxiway, switches from one taxiway to the next, and the switch from the last taxiway to the runway. ....	353
Table 7-11 Taxiway Indices for the new definition of the example taxipath; the definition now contains the taxiway indices for movement along the entire taxipath (from gate to each taxiway to the runway). .....	354
Table 7-12 Nodes generated after the first pass over all taxiway positions for the taxi network layout presented in Figure 7-10.....	355

Table 7-13 Additional nodes generated after the second pass over all taxiway positions in the taxi network layout presented in Figure 7-10. ....	356
Table 7-14 Taxiway Indices of the example outbound taxipath (Gate G -> Runway End 1) along with the node IDs corresponding to each taxiway index. ....	357
Table 7-15 Network Path Version of the Example Taxipath .....	358
Table 8-1 Full Example Schedule for the Year 2019.....	378
Table 8-2 Like Entries Combined, Average Annual Day .....	379
Table 10-1 ACS Data Tables used by Environmental Justice.....	384
Table 10-2 ACS Data Tables Used by Limited English Proficiency .....	386
Table 10-3 Environmental Justice Demographic Variables, from the ACS .....	387
Table 10-4 Environmental Justice Demographic Variables, Derived from ACS .....	388
Table 10-5 2020 Limited English Proficiency Demographic Variables .....	389
Table 10-6 Language Categories in the 2015 American Community Survey Dataset .....	390
Table 11-1 Average Atmospheric Attenuation Rates from SAE-AIR-1845 <sup>3</sup> .....	402
Table 11-2 Spectra for V2527 NPD from ANP Database and Calculated Source Spectra.....	406
Table 11-3 Reference Absorption Coefficients (from Table 11-1) and Coefficients for 10°C/80% Relative Humidity/101.325 kPa Calculated using SAE-ARP-866A <sup>2</sup> and SAE-ARP-5534 <sup>4</sup> .....	407
Table 11-4 A-weighted Levels for Reference and SAE-ARP-866A Atmosphere and Difference Between Each Atmosphere, $\Delta_L$ .....	408
Table 11-5 A-weighted Levels for Reference and SAE-ARP-5534 <sup>4</sup> Atmosphere and Difference Between Each Atmosphere, $\Delta_L$ .....	408
Table 11-6 Original NPD Data .....	409
Table 11-7 Revised NPD Data Using SAE-ARP-866A <sup>2</sup> .....	409
Table 11-8 Revised NPD Data Using SAE-ARP-5534 <sup>4</sup> .....	409
Table 11-9 One-Third Octave Band Characteristics .....	411
Table 11-10 EASN Threshold.....	413
Table 11-11 OEP Airport Atmospheric Condition Statistics.....	419
Table 11-12 Summary of A-weighted $\Delta AA_{adj}$ .....	421
Table 11-13 Summary of A-Weighted $\Delta LOS_{adj}$ .....	423
Table 11-14 Reference Conditions for Performance Data .....	425
Table 11-15 General Aircraft and Engine Data Form .....	426
Table 11-16 Departure Takeoff Weights Form .....	427
Table 11-17 Guidance for Determining Departure Takeoff Weights.....	427
Table 11-18 Aerodynamic Coefficients Form.....	428
Table 11-19 Jet Engine Coefficients Form.....	429
Table 11-20 Propeller Engine Coefficients Form .....	430
Table 11-21 Default Takeoff Procedure Descriptions.....	431
Table 11-22 Takeoff Procedure Profile Form.....	432
Table 11-23 Takeoff Profile Points Form .....	433
Table 11-24 Approach Procedure Profile Form .....	435

---

Table 11-25 Approach Profile Points Form .....	435
Table 11-26 NPD Data Form .....	438
Table 11-27 Spectral Data Form .....	439
Table 11-28 Reference Conditions for Performance Data .....	440
Table 11-29 General Aircraft and Engine Data Form .....	441
Table 11-30 Departure Takeoff Weights Form .....	442
Table 11-31 Guidance for Determining Departure Takeoff Weights.....	442
Table 11-32 Aerodynamic Coefficients Form.....	443
Table 11-33 Propeller Engine Coefficients Form .....	444
Table 11-34 Takeoff Procedural Profile Form.....	445
Table 11-35 Takeoff Profile Points Form .....	446
Table 11-36 Approach Procedural Profile Form .....	447
Table 11-37 Approach Profile Points Form .....	448
Table 11-38 NPD Data Form .....	450
Table 11-39 Spectral Data Form .....	452
Table 11-40 Reference Conditions for Performance Data.....	453
Table 11-41 General Helicopter and Engine Data Form .....	454
Table 11-42 Helicopter Speed Coefficients.....	455
Table 11-43 Helicopter Departure Procedures Form .....	456
Table 11-44 Helicopter Approach Procedures Form .....	457
Table 11-45 Helicopter Taxi Procedures for a Helicopter with Wheels Form .....	457
Table 11-46 Helicopter Taxi Procedures for a Helicopter without Wheels Form.....	458
Table 11-47 Noise Type for Each Helicopter NPD Data Set .....	459
Table 11-48 Operation Mode for Each Helicopter NPD Data Set.....	459
Table 11-49 Helicopter NPDs for Dynamic Operations Form .....	460
Table 11-50 Helicopter NPDs for Static Operations Form .....	461
Table 11-51 Noise Data Substitutes for Missing Operational Modes.....	462
Table 11-52 NPD Adjustments for Helicopter Operations Form .....	462
Table 11-53 Helicopter Spectral Data for Spectral Class Determination Form .....	463
Table 11-54 Helicopter Directivity Adjustment Data Form .....	465
Table 13-1 Methodology and Data Sources for Boilers/Heaters.....	478
Table 13-2 Required Parameter Specifications for Boilers and Space Heaters .....	478
Table 13-3 Typical Pollution Control Efficiencies for Boiler/Heater Controls.....	479
Table 13-4 Input Parameters by Tank Type .....	482
Table 13-5 Fuel Tank Vapor Molecular Weight and Liquid Density.....	483
Table 13-6 Typical Pollution Control Efficiencies for Solvent Degreasing Controls.....	485
Table 13-7 Input Parameters for Emissions from Particulate Piles .....	485
Table 13-8 List of Engine Variables for Plume Rise Calculations .....	486
Table 13-9 Source Group (Source Mode) Definitions.....	487
Table 13-10 Aircraft Source Group Mapping and Options .....	491
Table 14-1 2019 Operational Profiles for Example GSE Population Emissions Calculation.....	494

Table 14-2 Calculated Daily Weights for Two-Week Modeling Period..... 495



## LIST OF FIGURES

Figure 1-1 AEDT System Structure .....	2
Figure 1-2 A-weighted and C-weighted Adjustment Curves.....	4
Figure 3-1 Cascade of Weather Data Sources.....	61
Figure 3-2 Track Computation – Pointwise Departure Track.....	72
Figure 3-3 Track Computation – Vector Departure Track.....	72
Figure 3-4 Track Computation – Pointwise Approach Track.....	73
Figure 3-5 Track Computation – Vector Approach Track.....	73
Figure 3-6 Track Computation – Pointwise Overflight Track .....	74
Figure 3-7 Track Computation – Pointwise Circuit/TGO Track .....	74
Figure 3-8 Track Computation – Vector Circuit/TGO Track .....	75
Figure 3-9 Track Alignment – Departure Procedure.....	78
Figure 3-10 Track Alignment – Approach Procedure.....	78
Figure 3-11 Track Alignment – Overflight Procedure .....	78
Figure 3-12 Track Alignment – TGO Procedure .....	79
Figure 3-13 Track Alignment – Circuit Procedure .....	79
Figure 3-14 Thrust Rating Comparison – Takeoff Thrust, 15% Reduced Thrust.....	85
Figure 3-15 Smoothing of discontinuities at step interfaces. Modeled profiles (solid black with endpoints) show how thrust, speed, and altitude are actually modeled. Deviations in smoothed profiles from the modeled profiles are shown in grey. ....	105
Figure 3-16 Example of Bank Angle Smoothing, Filtering, and Limiting .....	112
Figure 3-17 Illustration of Takeoff Thrust Transition Segment Insertion .....	136
Figure 3-18 Reduced Thrust to Full Thrust Transition .....	139
Figure 3-19 Altitude Controls.....	151
Figure 3-20 Effect of BADA 3 Maximum Altitude on Interpretation of “AtOrBelow” Controls.....	152
Figure 3-21 Preserved Portion of Standard Path in Altitude-Controlled Flights.....	154
Figure 3-22 Phases of Best-Effort Calculation through Recursive Bisection.....	157
Figure 3-23 Candidate Altitudes for Flight To or From an “AtOrBelow” Altitude Control .....	158
Figure 3-24 Relationships Between Initial, Final, Latest, and Candidate for Departures and Overflights.....	159
Figure 3-25 Relationships Between Initial, Final, Latest, and Candidate for Approaches .....	159
Figure 3-26 Schematic of BADA 4 Sensor Path Arrival Configuration Schedule .....	182
Figure 3-27 Example of an AtORBelow Control Point at Segment Number 10 .....	183
Figure 3-28 Example of the Altitude Performance Result for an Airplane Modeled with the Track from Figure 3-27 .....	184
Figure 3-29 SEL as a Function of the Track Distance for the Example Operation.....	185
Figure 4-1 Flight-Segment Geometry when a Receptor Is Behind a Segment.....	188
Figure 4-2 Flight-Segment Geometry when a Receptor Is Astride a Segment .....	189
Figure 4-3 Flight-Segment Geometry when a Receptor Is Ahead of a Segment .....	189
Figure 4-4 Lateral Attenuation Geometry.....	204
Figure 4-5 Bank Angle $\epsilon$ , Elevation Angle $\beta$ , Depression Angle $\phi$ , and Lateral Distance $\ell^{25}$ .....	204

Figure 4-6 Illustration of Engine-Installation Effects for Jet-Powered Airplanes <sup>25</sup> .....	206
Figure 4-7 Illustration of Ground-to-Ground Component of Lateral Attenuation .....	207
Figure 4-8 Illustration of Air-to-Ground Component of Lateral Attenuation .....	208
Figure 4-9 Illustration of Ground-to-Ground Component of Lateral Attenuation for Military Aircraft ...	209
Figure 4-10 Illustration of Air-to-Ground Component of Lateral Attenuation for Military Aircraft .....	210
Figure 4-11 Line-of-Sight (LOS) Blockage Concept.....	211
Figure 4-12 Modeling of Thrust Reverser Deployment During Landing Ground Roll.....	216
Figure 4-13 Ground-Based Directivity Adjustment for Turbofan-powered Jet Aircraft and Turboprop Aircraft .....	218
Figure 4-14 Elevation Angle for Helicopter Lateral Directivity Adjustment.....	221
Figure 4-15 Example Helicopter Sound Pressure Levels According to Elevation Angle .....	222
Figure 4-16 AEDT Acoustic Computation Process without Terrain for a Single Flight Segment .....	224
Figure 4-17 AEDT Acoustic Computation Process with Terrain for a Single Flight Segment .....	225
Figure 4-18 AEDT Accumulation of Acoustic Computation Process .....	237
Figure 4-19 Uncompressed Time Audible.....	246
Figure 4-20 A Delaunay triangulation of a set of six input points (shown on the left). The five triangles produced by the triangulation each have circumcircles within which no input point exists (shown on the right).....	250
Figure 4-21 A triangulation of a set of six input points which is not a Delaunay triangulation. This fact is revealed by drawing the circumcircles of the five triangles and noticing that the upper two triangles each have an input point within their respective circumcircle. ....	251
Figure 4-22 A bounding triangle is generated for each set of input points. The triangle <i>DEF</i> is the bounding triangle generated for the input points A, B, and C.....	252
Figure 4-23 Input points are inserted into the triangulation one at-a-time. Each input point insertion replaces a triangle by three new triangles. The first point inserted (point A) replaces the triangle <i>DEF</i> , by the three triangles <i>ADE</i> , <i>ADF</i> , and <i>AEF</i> . ....	254
Figure 4-24 The insertion of point B replaces triangle <i>ADE</i> by three new triangles ( <i>ABD</i> , <i>ABE</i> , and <i>BDE</i> ). ....	255
Figure 4-25 Two adjacent triangles that are checked for satisfaction of the Delaunay condition. The check determines whether the side <i>AD</i> must be flipped to <i>BC</i> and replace the triangles <i>ABD</i> and <i>ACD</i> by the triangles <i>ABC</i> and <i>BCD</i> . ....	256
Figure 4-26 The insertion of point C replaces triangle <i>ADF</i> by three new triangles ( <i>ACD</i> , <i>ACF</i> , and <i>CDF</i> ). ....	257
Figure 4-27 A check on the insertion of point C determines that triangles <i>CDF</i> and <i>CDF</i> do not satisfy the Delaunay condition. The common side <i>AD</i> (shown in orange) must be changed to <i>BC</i> (shown in gray). The triangles <i>ABD</i> and <i>ACD</i> are redefined to <i>ABC</i> and <i>BCD</i> .....	258
Figure 4-28 A Delaunay triangulation of a set of thirty points. The three bounding triangle vertices and all bounding triangles have been omitted from the diagram. ....	260

Figure 4-29 The convex hull of the triangulation presented in Figure 4-28. An interpolated value can be determined anywhere within the convex hull. The interpolation is a three-point interpolation based on the acoustics values associated with the vertices of the triangle that encloses the arbitrary location...	261
Figure 4-30 A Delaunay triangulation of a set of thirty points. The input points are at different locations than those presented in Figure 4-28. The three bounding triangle vertices and all bounding triangles have been omitted from the diagram. ....	262
Figure 4-31 The convex hull of the triangulation presented in Figure 4-30. An interpolated value can be determined anywhere within the convex hull. The interpolation is a three-point interpolation based on the acoustics values associated with the vertices of the triangle that encloses the arbitrary location...	263
Figure 4-32 Triangulations associated with Figure 4-28 and Figure 4-30 overlaid. In this diagram, the Figure 4-28 triangulation is considered the base field while the Figure 4-30 triangulation is considered the alternate field. ....	264
Using Figure 4-33 as a reference, the combination algorithm will generate a combined point set that consists of the following: .....	264
Figure 5-1 TOG, NMHC, and VOC Calculations for Turbine Engines.....	273
Figure 5-2 TOG, NMHC, and VOC Calculations for Piston Engines .....	275
Figure 6-1 Source Groups in the AERMOD.INP File .....	298
Figure 6-2 Flight Segment Splitting Algorithm.....	304
Figure 6-3 Creation of a New User-Defined APU .....	307
Figure 6-4 Creation of a New User-Defined GSE.....	308
Figure 6-5 Creation of a New User-Defined Stationary Source .....	311
Figure 6-6 Hourly Background Concentration File Example .....	313
Figure 6-7 NO <sub>2</sub> /NO <sub>x</sub> Ratios for Jet Engines from Timko et. al.....	316
Figure 6-8 In-Stack Ratios from the ACRP Project 02-43 .....	317
Figure 7-1 An Activation Parameter Value and its Criteria Range for Some Configuration and Hour .....	334
Figure 7-2 Intersection of Two Taxiway Segments (q and r) .....	338
Figure 7-3 Modified Rectangular Representation of Two Taxiway Segments (Q and R).....	340
Figure 7-4 Taxiway Segment Intersection with a Polygon Gate .....	342
Figure 7-5 Projection of a Point p onto a Line Segment Defined by Endpoints p1 and p2.....	343
Figure 7-6 Intersection of Two Taxiways .....	344
Figure 7-7 Taxiway-Runway Intersection.....	346
Figure 7-8 Taxiway-Gate Intersections .....	347
Figure 7-9 Simple Taxi Network .....	348
Figure 7-10 Simple Taxi Network with Intersection Points.....	349
Figure 7-11 Inbound Network Path Exit Property Definitions .....	359
Figure 7-12 Data Flow of the Delay-and-Sequencing (Queuing) Algorithm .....	364
Figure 7-13 Airside Queuing Model within WWLMINET .....	365
Figure 7-14 Airport Configuration Capacity Pareto Frontier .....	366
Figure 7-15 Example of a Runway End Serving Traffic from Several Queues.....	369
Figure 11-1 Acoustic Impedance Adjustment re. 406 newton-second/m <sup>3</sup> .....	393
Figure 11-2 Acoustic Impedance Adjustment re. 400 newton-second/m <sup>3</sup> .....	393

---

Figure 11-3 Observer/Flight Path Geometry .....	396
Figure 11-4 Meteorological Conditions Recorded During Noise Certification Tests <sup>56</sup> .....	403
Figure 11-5 EASN Threshold.....	412
Figure 11-6 Departure Class 104.....	417
Figure 11-7 Normalized Spectral Class 104 Data .....	418
Figure 11-8 Range of Average Airport Atmospheric Conditions Represented in the AEDT Database .....	419
Figure 11-9 Histogram of A-weighted $\Delta A_{adj}$ .....	420
Figure 11-10 Histogram of A-Weighted $\Delta LOS_{adj}$ .....	422
Figure 11-11 Departure Spectral Class 104.....	424
Figure 11-12 Example Maximum Takeoff Thrust vs. Temperature .....	429
Figure 11-13 Shape Comparison of Spectral Data .....	468
Figure 13-1 List of Engine Variables for Plume Rise Calculations .....	487
Figure 13-2 CO Pathway Changes .....	490
Figure 13-3 SO Pathway Changes .....	492
Figure 13-4 AERMOD PLOTFILES.....	493

## 1. Introduction

### 1.1 Overview

The Aviation Environmental Design Tool (AEDT) is a software system that models aircraft performance in space and time to estimate noise, fuel consumption, emissions, and air quality impacts. AEDT is designed to process individual studies ranging in scope from a single flight at an airport to scenarios at the regional, national, and global levels. AEDT leverages geographic information system (GIS) and relational database technology to achieve this scalability and offer rich opportunities for exploring and presenting results. AEDT is actively used by the U.S. government for regulatory studies, research, and domestic aviation system planning, as well as domestic and international aviation environmental policy analysis.

In contrast to the individual legacy noise and air quality analysis tools such as, Integrated Noise Model (INM) and Emissions and Dispersion Modeling System (EDMS), AEDT unifies noise, fuel consumption, and emissions calculation capabilities into a single application. AEDT includes a database of over 3,000 airframe-engine combinations and runway information for over 30,000 airports around the globe. These system databases allow users of AEDT to quickly build studies and estimate the interdependencies between noise, fuel consumption, and emissions impacts of aviation activity.

### 1.2 System Architecture

AEDT is built on the Microsoft .NET Framework and SQL Server and is capable of running on Windows 10 and Windows Server 2016 operating systems. It is supported by extensive system databases covering airports, airspace, and fleet information that span the global nature of the aviation industry.

All information is rendered in a geospatial nature given the Esri-based core of the tool, which supports the compatibility with other geospatial applications. State-of-the-art software technology is used to enhance the capabilities of AEDT, such as the XML-based AEDT Standard Input File (ASIF) that allows for the input of large datasets of 4D trajectories, fleet information, and event assignments.

AEDT outputs include reports, graphs, and tables that summarize the flight performance, fuel burn, emissions inventories, noise results, contours, and emissions dispersion results. The diagram in Figure 1-1 highlights the AEDT system structure.

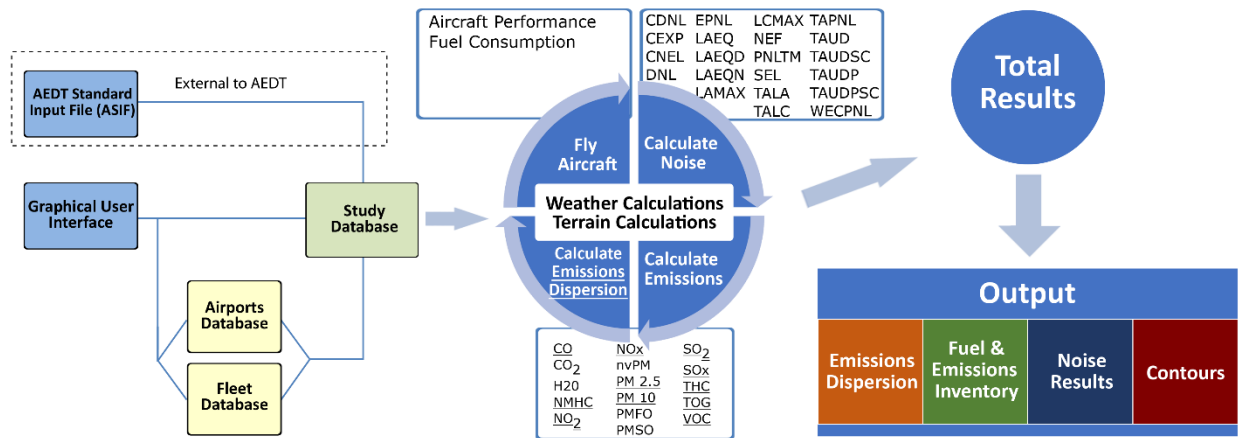

Figure 1-1 AEDT System Structure

### 1.3 About this Technical Manual

This manual presents the technical details of the methodologies employed by AEDT with respect to its primary functionality. The intended target audience is users who would like a deeper understanding of the technical details of how AEDT models noise, fuel burn, environmental inventories, and emissions dispersion. For information on how to use the AEDT application, please refer to the AEDT User Manual<sup>1</sup>.

This Technical Manual is organized into the following sections:

- Section 1 provides an introduction.
- Section 2 describes the AEDT databases and input data.
- Section 3 presents the models for aircraft performance.
- Section 4 presents the models related to noise computations and adjustments.
- Section 5 presents the models related to emissions inventory.
- Section 6 presents the models related to emissions dispersion.
- Section 7 presents the models related to ground operations.
- Section 8 provides an overview of annualization.
- Section 9 describes the methodology employed for change analysis and impact evaluation.
- Section 10 describes the environmental justice capability.
- Section 11 presents additional information on:
  - Noise metric derivations;
  - Noise data development; and
  - Aircraft noise and performance data submittal, verification and validation.
- Section 12 discusses the BADA 4 Model.

- Section 13 presents additional information on:
  - Algorithm for constructing AERMOD sources; and
  - Emissions factor calculation for stationary sources and training fires.
- Section 14 provides an example of GSE population emissions inventory calculation.
- Section 15 describes the map projection method.
- Section 16 lists the references in this manual.

1.4 Terminology

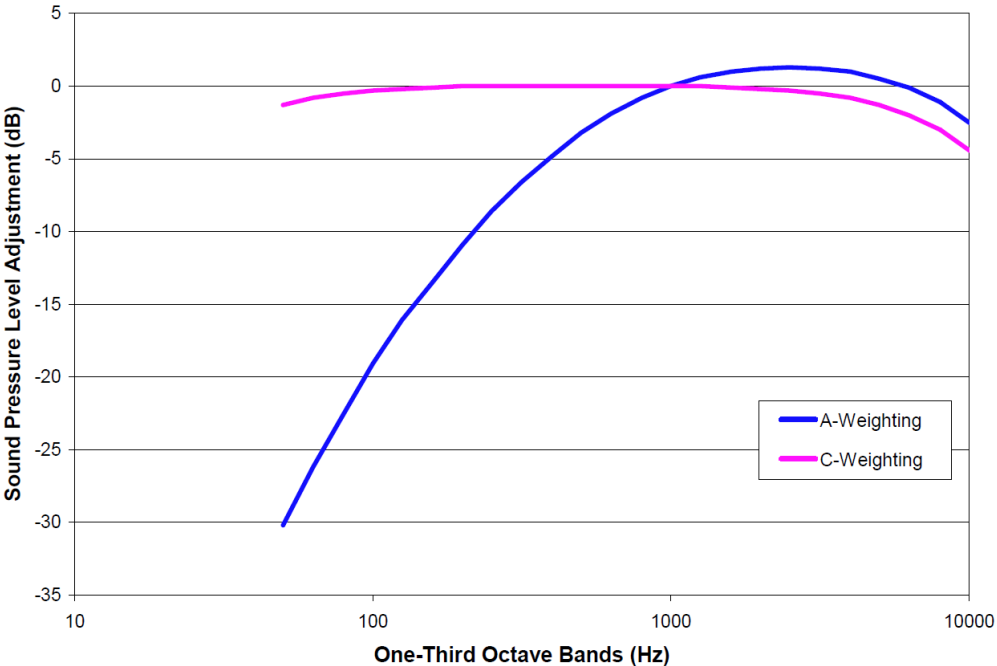
<p><b>A-weighted</b></p>	<p>A-weighted <b>noise</b> levels emphasize sound components in the frequency range where most speech information resides, yielding higher levels in the mid-frequency (2,000 to 6,000 Hz) range and lower levels in both low frequency and high frequency ranges. A-weighted <b>noise</b> level is used extensively for measuring and predicting community and transportation <b>noise</b>. The A-weighted and <b>C-weighted</b> adjustment curves are presented in Figure 1-2:</p>  <p style="text-align: center;">Figure 1-2 A-weighted and C-weighted Adjustment Curves</p>
<p><b>Above Field Elevation (AFE)</b></p>	<p>Altitude relative to the airport elevation in feet. The FAA defines the airport elevation as the highest point of an airport’s usable runways. Therefore AFE equals the altitude (measured in height above mean sea level [MSL]) minus the airport elevation (measured in height above MSL).</p>
<p><b>Above Ground Level (AGL)</b></p>	<p>Altitude relative to the elevation of the ground in feet.</p>
<p><b>Above Runway Elevation (ARE)</b></p>	<p>The altitude (feet) of the aircraft relative to either the departure or arrival runway, depending on the operation type.</p>
<p><b>Acoustic Impedance Adjustment</b></p>	<p>A sound level adjustment, computed as a function of <b>receptor</b> temperature, pressure, and elevation, which is applied to <b>noise-power-distance (NPD) noise</b> levels. Specific acoustic impedance is the product of the density of air and the speed of sound, and is related to the propagation of sound waves in an acoustic medium.</p>
<p><b>Acoustically Hard Surface</b></p>	<p>A highly reflective surface where the phase of the incident sound is essentially preserved upon reflection; example surfaces include water, asphalt, and concrete.</p>
<p><b>Acoustically Soft Surface</b></p>	<p>A highly absorptive surface where the phase of the incident sound is changed substantially upon reflection; example surfaces include ground covered with dense vegetation or freshly-fallen snow.</p>



<b>Activation Parameter</b>	In the context of airport configurations, an activation parameter is a parameter whose value for a given hour must satisfy a set of user-specified lower and/or upper bound criteria in order to activate the configuration. Ordinarily, a configuration is activated when all of the activation parameter values for a given hour (the current conditions) satisfy the respective criteria of the configuration and no other configuration has higher priority. The activation parameters are: wind speed, wind direction, hour of the day, ceiling, visibility and temperature.
<b>Active Configuration</b>	The active configuration is the airport <b>operating configuration</b> which is in effect for a given hour of some analysis year.
<b>Advancing Tip Mach Number</b>	The relative airspeed (in <b>Mach</b> ) of the advancing blade tip of a helicopter's main rotor, accounting for airspeed, temperature and/or rotor RPM.
<b>Advancing Tip Mach Number Adjustment</b>	Refer to <b>Source Noise Adjustment Due to Advancing Tip Mach Number</b> .
<b>AERMET</b>	AERMET is a meteorological data preprocessor for <b>AERMOD</b> .
<b>AERMINUTE</b>	AERMINUTE processes <b>ASOS</b> 1-minute and 5-minute wind data to generate hourly average winds for input to <b>AERMET</b> .
<b>AERMOD</b>	AERMOD is the U.S. Environmental Protection Agency (USEPA)'s near-field dispersion model that AEDT uses to model atmospheric dispersion.
<b>AERSURFACE</b>	AERSURFACE is a tool that processes land cover data to determine the surface characteristics for use in <a href="#">AERMET</a> .
<b>Air-to-Ground Attenuation</b>	Refer to <b>Refraction-Scattering Effects</b> .
<b>Aircraft Speed Adjustment</b>	An adjustment made to exposure-based <b>noise</b> levels when aircraft speed differs from 160 KCAS, the <b>reference speed</b> for <b>NPD</b> data.
<b>Ambient (noise)</b>	The composite, all-inclusive sound associated with a given environment, excluding the analysis system's electrical <b>noise</b> and the sound source of interest. Several definitions of ambient <b>noise</b> have been adopted by different organizations depending on their application, such as natural ambient (natural sound condition in an area, excluding all human and mechanical sounds), existing ambient without aircraft (all-inclusive sound associated with a given environment, excluding the analysis system's electrical <b>noise</b> and the sound source of interest: aircraft), etc. Ambient data implementation in AEDT utilizes different ambient file formats specific to different noise metrics.
<b>Annualization</b>	The general term used for the hierarchical collection of reusable operation groups along with a weighting scheme to represent the aviation traffic to be modeled in a metric result.
<b>Approach</b>	A <b>flight operation</b> that begins in the terminal control area, descends, and lands on an airport runway, possibly exerts reverse thrust, and decelerates to taxi speed at some location on the runway.
<b>ASIF</b>	AEDT Standard Input File (ASIF) is based on the XML format and provides a standard file format to allow for the import of data into AEDT.
<b>ASOS</b>	Automated Surface Observing System (ASOS) is used at most of the National Weather Service (NWS) stations to collect surface meteorological data. It is optional to provide 1-minute and 5-minute ASOS weather files to supplement surface wind speed and direction when generating AERMOD weather files.

<b>Atmospheric Absorption</b>	The change of acoustic energy into another form of energy (heat) when sound passes through the atmosphere. Several parameters such as temperature, pressure, and humidity are needed to specify the amount of atmospheric absorption, which is dependent upon the frequency of the sound as well. <b>NPD</b> data are corrected for atmospheric absorption in accordance with the Society of Automotive Engineers (SAE) Aerospace Recommended Practice (ARP) 866A <sup>2</sup> (SAE-ARP-866A), SAE Aerospace Information Report (AIR) 1845 <sup>3</sup> (SAE-AIR-1845), and SAE ARP 5534 <sup>4</sup> (SAE-ARP-5534).
<b>Audibility</b>	The measure of ability for an attentive listener to hear a particular acoustic event such as aircraft noise. Audibility is based on detectability from signal detection theory, and depends on both the actual aircraft sound level (“signal”) and the ambient sound level (or “noise”). The metric associated with audibility in AEDT is Time Audible.
<b>Average Annual Day</b>	The user-defined best representation of the typical annual conditions for the case airport. These conditions include the number and type of operations, runway usage, routing structure, temperature, atmospheric pressure, etc.
<b>Bank Angle</b>	The roll angle about the aircraft’s longitudinal axis. By convention a left turn has a positive bank angle, and a right turn has a negative bank angle. Bank angle is presented in Figure 4-5.
<b>Boeing Fuel Flow Method 2 (BFFM2)</b>	Boeing Fuel Flow Method 2 is used to compute NO <sub>x</sub> , THC, and CO in AEDT. It is also used to calculate taxi fuel burn per SAE AIR-8035 <sup>5</sup> . Refer to Section 5.1.1.1. BFFM2 is part of the SAE-AIR-6183 <sup>6</sup> terminal area fuel consumption standard.
<b>C-weighted</b>	C-weighted <b>noise</b> levels, as compared with <b>A-weighted noise</b> levels, emphasize sound components between 100 Hz and 2 kHz. C-weighting is intended to simulate the sensitivity of the human ear to sound at levels above about 90 dB. C-weighted <b>noise</b> levels are commonly used for assessing scenarios dominated by low-frequency sound, e.g., locations behind start-of-takeoff roll. The <b>A-weighted</b> and C-weighted adjustment curves are presented in Figure 1-2.
<b>Calibrated Airspeed (CAS)</b>	The indicated airspeed of an aircraft (as read from a standard airspeed indicator), corrected for position and instrument error. Calibrated airspeed is equal to <b>true airspeed</b> in the standard atmosphere at sea level. The standard aviation abbreviation “KCAS” is used when the units are knots.
<b>Change in Exposure (Delta Dose or DDOSE)</b>	The difference between the cumulative, <b>A-weighted, sound exposure level</b> (L <sub>AE</sub> ) due to aircraft <b>noise</b> and the user-specified <b>A-weighted ambient</b> level at a given receiver location over a user-specified time period <sup>i</sup> .
<b>Circuit Flight</b>	A <b>flight operation</b> that combines a <b>departure</b> from and an <b>approach</b> to the same runway, with level-flight and/or varying-altitude segments in between.
<b>Closest Point of Approach (CPA)</b>	Point on the <b>flight path segment</b> , not the <b>extended flight path segment</b> , which is the closest point of approach to the <b>receptor</b> .
<b>Contour</b>	An analysis of an area in the vicinity of an airport encompassed by a graphical plot consisting of a smooth curve, statistically regressed through points of equal level or time duration.

<sup>i</sup> It is important to note that in AEDT, Change in Exposure uses a default time period of 12 hours. In addition, Change in Exposure levels below the specified threshold level will be reported as 0.0 dB, and levels are capped at 150 dB.

<b>Corrected Net Thrust Per Engine</b>	The <b>net thrust</b> per engine divided by the ratio of the <b>ambient</b> air pressure at aircraft altitude to the <b>International Standard Atmosphere (ISA)</b> air pressure at mean sea level.
<b>Decibel (dB)</b>	A unit of measure for defining a <b>noise</b> level or a <b>noise exposure</b> level. The number of decibels is calculated as $10\log_{10}$ of the ratio of mean-square pressure or <b>noise exposure</b> . The reference root-mean-square pressure is 20 $\mu\text{Pa}$ , the threshold of human hearing.
<b>Density Ratio</b>	The ratio of density to the <b>ISA</b> sea-level value.
<b>Departure</b>	A <b>flight operation</b> that begins on a runway, proceeds down the runway, and climbs and accelerates to altitudes at specified distances.
<b>Depression Angle</b>	The angle between a line along the span of the aircraft's wing and a line parallel to the <b>ground plane</b> , which is a combination of the aircraft <b>bank angle</b> and <b>elevation angle</b> . Depression angle is presented in Figure 4-5.
<b>Detectability</b>	The ability to detect a signal in the presence of noise, based on signal detection theory. For the purposes of AEDT modeling, the terms "audibility" and "detectability" are used interchangeably.
<b>Directivity Adjustment</b>	A <b>noise</b> level adjustment resulting from the normalized <b>noise</b> pattern defined by a 360-degree area in the horizontal plane around a <b>noise</b> source. In AEDT, measurement-based directivity is accounted for in takeoff ground roll and <b>runup</b> operations for fixed wing aircraft with the <b>Ground-Based Directivity Adjustment</b> ( $\text{DIR}_{\text{ADJ}}$ ). It is also accounted for in all static helicopter operating modes with the <b>Static Directivity Adjustment</b> ( $\text{DIR}_{\text{HEL}_\text{ADJ}}$ ).
<b>Distance Duration</b>	An empirically-derived effect, expressed as a function of distance, which relates exposure-based <b>noise</b> levels to maximum-based <b>noise</b> levels. This effect is taken into account in the AEDT <b>NPD</b> data only for data corrected using the simplified data adjustment procedure in SAE-AIR-1845 <sup>3</sup> .
<b>Duration Adjustment</b>	A <b>noise</b> level adjustment to exposure-based metrics to account for the effect of time-varying aircraft speed other than 160 knots (the <b>NPD reference speed</b> ). Both acceleration and deceleration are accounted for with the Duration Adjustment ( $\text{DUR}_{\text{ADJ}}$ ). It is not applied to <b>maximum noise level</b> metrics since they are mostly independent of speed. Helicopters also utilize duration adjustments; however they are based on helicopter-specific <b>reference speeds</b> . In addition, helicopters have a specific <b>Static Operation Duration Adjustment</b> ( $t_{\text{HELL\_static}}$ ) to account for duration effects due to <b>static operations</b> such as Hover, <b>Ground Idle</b> , and <b>Flight Idle</b> .
<b>Elevation Angle</b>	The angle between the line representing the propagation path between the aircraft source and receiver (at the aircraft's closest point of <b>approach</b> ) and the line from the receiver to the projection of the <b>flight path</b> on the ground. Elevation angle is presented in Figure 4-5.
<b>Emissions Index (EI)</b>	A unique value for calculating emissions based on activity data in terms of a standard rate of emissions per unit of activity (e.g., grams of carbon dioxide emitted per kg of fuel consumed).
<b>Engine Breakpoint Temperature</b>	The ambient air temperature (degrees <b>F</b> ) above which the thrust output from a flat-rated engine begins to decrease.

<b>Engine Installation Effect</b>	A component of the <b>lateral attenuation adjustment</b> that takes into account the directivity of the sound from an aircraft as a function of engine/aircraft type (jet, prop, helicopter), engine mounting location (fuselage or wing), and <b>depression angle</b> .
<b>Equivalent Airspeed</b>	For an aircraft experiencing a given incompressible dynamic pressure, equivalent airspeed is the true airspeed at which the aircraft would experience the same incompressible dynamic pressure at <b>ISA</b> sea-level density.
<b>Equivalent Auditory System Noise (EASN)</b>	Equivalent Auditory System Noise (EASN) is the minimum threshold for audibility. It represents the lowest sound pressure levels detectable by humans with average hearing (on a one-third octave band basis), and is used in combination with an ambient file to compute audibility in AEDT.
<b>ESRI</b>	Software development and services company providing GIS software and geodatabase management applications.
<b>Extended Flight Path Segment</b>	A mathematical extension from either end of a geometrical flight path segment to infinity, used in AEDT for the computation of exposure based noise metrics.
<b>First Order Approximation (FOA)</b>	First Order Approximation (FOA) version 4.0 is used in AEDT to compute non-volatile, volatile, and total particulate matter mass and number. Refer to Section 5.1.1.2.
<b>Flight Idle</b>	A static helicopter operation, where the helicopter is on the ground with the main rotor(s) operating at the same speed used for flight operations, but without generating lift.
<b>Flight Operation</b>	A moving (or dynamic) aircraft operation. There are five kinds of flight operations for fixed-wing aircraft in AEDT: <b>approach, departure, overflight, circuit flight, and touch and go</b> . There are three kinds of flight operations for helicopters in AEDT: <b>approach, departure, and helitaxi</b> .
<b>Flight Path</b>	A set of <b>flight path segments</b> describing geometrical and physical parameters used to model the movement of an aircraft in three-dimensional space. Each flight path point contains: (1) the geographical location (x- and y-value) relative to the origin of the airport, (2) the aircraft altitude <b>above field elevation</b> , (3) the aircraft <b>ground speed</b> (this is also the aircraft's <b>true airspeed</b> in situations of level flight and no wind), (4) the <b>corrected net thrust per engine</b> or equivalent parameter used to access the <b>NPD</b> curves, (5) duration (seconds) of the flight path segment following the point, and (6) aircraft <b>bank angle</b> for the flight path segment following the point (if applicable).
<b>Flight Path Processing Module (FPPM)</b>	The AEDT Flight Path Processing Module calculates trajectories to match altitude control definitions across all relevant phases of flight for civilian jet, turboprop, and piston propeller driven airplanes.
<b>Flight Path Segment</b>	A directed straight line in three-dimensional space, which includes the aircraft <b>ground speed</b> and <b>corrected net thrust per engine</b> at the beginning point of the line, and change in speed and thrust along the line to the end point.

<b>Flight Profile</b>	A set of points that models the geometrical and physical characteristics of an aircraft <b>flight operation</b> in the vertical plane. Each profile point contains: (1) the ground distance (x-value) relative to the origin of the operation, (2) the aircraft altitude <b>above field elevation</b> , (3) the aircraft <b>true airspeed</b> , and (4) the <b>corrected net thrust per engine</b> or equivalent parameter used to access the <b>NPD</b> curves. <b>Profile points</b> representing static operating modes within a helicopter profile also include the duration of time spent at the defined profile point.
<b>Ground-Based Directivity Adjustment</b>	Refer to <b>Directivity Adjustment</b> .
<b>Ground Effects (or Ground-to-Ground Attenuation)</b>	A component of the <b>lateral attenuation adjustment</b> that takes into account the effects of sound propagating along the ground surface considered to be “acoustically soft” (such as grass) as a function of <b>lateral distance</b> .
<b>Ground Idle</b>	A static helicopter state of operation, where the helicopter is on the ground with the main rotor(s) turning at less than the speed required for flight.
<b>Ground Plane</b>	Without terrain elevation processing, the ground plane is the geometric, horizontal plane at the elevation of the airport. With terrain elevation processing, the elevation of the ground plane is determined using the user-selected elevation data for the area surrounding the airport.
<b>Ground Speed</b>	The speed of an aircraft, including all spatial components, from a frame of reference of an observer on the ground.
<b>Ground-to-Ground Attenuation</b>	Refer to <b>Ground Effects</b> .
<b>Ground Track</b>	The trace of the <b>flight path</b> on the horizontal plane. Flight tracks are described as vector-type tracks consisting of one or more straight or curved segments, or point-type tracks consisting of an array of x,y points.
<b>Hover in Ground Effect (HIGE)</b>	A static helicopter state of operation, where the helicopter is hovering with the main rotor in aerodynamic ground effect (which are <i>not</i> the <b>ground effect</b> discussed above). Operations in aerodynamic ground effect require less power and are therefore typically quieter than <b>HOGE</b> operations.
<b>Hover out of Ground Effect (HOGE)</b>	A static helicopter state of operation, where the helicopter is hovering at a main rotor altitude above aerodynamic ground effect (which are <i>not</i> the <b>ground effect</b> discussed above). Operations out of aerodynamic ground effect require more power and are therefore typically louder than <b>HIGE</b> operations.
<b>Integrated Adjustment Procedure</b>	The preferred adjustment procedure used for developing <b>NPD</b> data from measured <b>noise</b> level data, which are used in AEDT. It is based on <b>noise</b> level data measured over the full spectral time history of an event. In the integrated procedure, off-reference aircraft speed, <b>atmospheric absorption</b> effects, and <b>spherical divergence</b> are considered. This adjustment procedure provides data consistent with Type 1 quality, as defined in SAE-AIR-1845 <sup>3</sup> . Refer to the definition of the <b>Simplified Adjustment Procedure</b> for comparison.
<b>Internally Mixed Turbofan</b>	Turbofan in which the bypass flow is also included during the measurement of the smoke number, indicating that the flow must take the bypass ratio into effect.

<b>International Standard Atmosphere (ISA)</b>	Internationally standardized functions of air temperature, pressure, and density versus aircraft altitude above mean sea level. The ISA is intended for use in calculations in the design of aircraft, in presenting test results of aircraft and their components under identical conditions, and to facilitate standardization in the development and calibration of instruments <sup>7</sup> .
<b>Lateral Attenuation Adjustment</b>	An adjustment that results from the attenuation of <b>noise</b> at grid points laterally displaced from the ground projection of an aircraft <b>flight path</b> . It is a combination of attenuation due to <b>ground effects</b> , attenuation due to <b>refraction-scattering effects</b> and <b>engine installation effects</b> , as defined in SAE-AIR-5662 <sup>27</sup> .
<b>Lateral Directivity Adjustment</b>	An adjustment that results from the linear interpolation between two of the three sets of helicopter <b>NPDs</b> (left, center and right), to account for helicopter in-flight directivity effects at a receiver location where the <b>elevation angle</b> is between -45 and 45 degrees.
<b>Lateral Distance</b>	The perpendicular distance from an aircraft's <b>ground track</b> to a receiver.
<b>Line-of-Sight Blockage Adjustment</b>	An adjustment that results from the attenuation due to line-of-sight (LOS) blockage from terrain features, and is based on the difference in propagation path length between the direct path and propagation path over the top of terrain features, known as path length difference.
<b>Mach</b>	A dimensionless number representing the true speed of an object moving through air divided by the local speed of sound.
<b>Maximum Noise Level</b>	The maximum of a series of modeled sound pressure levels from a single flight.
<b>Mean Sea Level (MSL)</b>	The level of the surface of the sea with respect to the land, taken to be the mean level between high and low tide, and used as a standard base for measuring heights and depths. The MSL designation is used to indicate that an altitude is specified with respect to mean sea-level. Units are typically feet; BADA 4 uses meters.
<b>Mean-Square Sound Pressure</b>	<p>A running time-average of frequency-weighted, squared instantaneous acoustic pressure. For example:</p> $p(t)_{AS}^2 = \int_{-\infty}^t P_A^2(\tau) \cdot e^{\frac{\tau}{t_0}} \frac{d\tau}{t_0}$ <p>where</p> <ul style="list-style-type: none"> <li><math>p(t)_{AS}^2</math> <b>A-weighted</b> mean-square pressure using slow exponential time;</li> <li><math>P_A^2</math> <b>A-weighted</b> mean-square pressure;</li> <li><math>\tau</math> Time; and</li> <li><math>t_0</math> Initial time = 1 second.</li> </ul>
<b>Mean-Square Sound Pressure Ratio</b>	The mean-square sound-pressure ratio is the ratio of the <b>mean-square sound pressure</b> divided by the square of the reference pressure 20 $\mu\text{Pa}$ . It is equivalent to $10^{\text{SPL}/10}$ , where <b>SPL</b> is the <b>sound pressure level</b> .
<b>Metric Family</b>	A set of <b>noise</b> -level and time-based metrics differentiated by frequency weighting, either <b>A-weighted</b> , <b>C-weighted</b> , or <b>tone-corrected perceived</b> .
<b>Metric Type</b>	A metric belongs to one of three types: exposure-based, maximum-level-based, or time-based.

<b>Mixing Height</b>	The altitude under which pollutants and other gases are considered well-mixed. The mixing height varies both diurnally and seasonally. AEDT uses a default mixing height of 3,000 ft (AFE) for emissions inventories, which can be modified by the user, but calculates emissions in the terminal area up to 10,000 ft and reports full flight emissions. For emissions dispersion, the mixing height varies by hour as modeled by AERMET; however, AEDT only includes emissions up to 3,000 ft AFE.
<b>Net Thrust</b>	The gross thrust of a jet engine minus the drag due to the momentum of the incoming air.
<b>Noise</b>	Any unwanted sound. “Noise” and “sound” are used interchangeably in this document.
<b>Noise Exposure</b>	Refer to <b>Sound Exposure</b> .
<b>Noise Fraction</b>	The ratio of <b>noise exposure</b> at a grid point due to a flight path segment, and the <b>noise exposure</b> at the same grid point due to a straight, infinite <b>flight path</b> extended in both directions from the segment. The noise fraction methodology is based upon a fourth-power 90-degree dipole model of sound radiation.
<b>Noise Fraction Adjustment</b>	An adjustment that is a function of the ratio of the <b>noise exposure</b> at a grid point due to a <b>flight path segment</b> , and the <b>noise exposure</b> at the same grid point due to a straight, infinite <b>flight path</b> , extended in both directions from the segment. The application of the noise fraction adjustment to the <b>NPD</b> data facilitates the modeling of a three-dimensional <b>flight path</b> , using straight flight path segments.
<b>Noise-Level Threshold</b>	A <b>noise</b> level specified by the user that is the boundary value above which <b>time-above</b> calculations are performed.
<b>Noise-Power-Distance (NPD) Data</b>	A set of <b>noise</b> levels, expressed as a function of: (1) engine power, usually the <b>corrected net thrust per engine</b> ; and (2) distance. The NPD data in AEDT are corrected for aircraft speed, <b>atmospheric absorption</b> , <b>distance duration</b> , and spherical spreading. For helicopters, <b>noise</b> levels are presented as a function of: (1) operation mode; and (2) distance.
<b>Number of Engines Adjustment</b>	An adjustment that is a function of the number of operative engines for an airplane conducting a <b>runup</b> and the total number of engines on the airplane.

<p><b>One-Third Octave-Bands</b></p>	<p>A method of characterizing the audio <b>spectrum</b> according to a series of frequency bands with constant-percentage-bandwidths, as described in ANSI S1.6-1984 (R2006) “Preferred Frequencies, Frequency Levels and Band Numbers for Acoustical Measurements”<sup>8</sup> and ANSI S1.11-2004 “Specification for Octave-Band and Fractional-Octave- Band Analog and Digital Filters.”<sup>9</sup> The standard one-third octave-bands used in AEDT are presented in Table 1-1.</p> <p style="text-align: center;">Table 1-1 Definition of One-Third Octave-Bands</p> <table border="1" style="margin-left: auto; margin-right: auto;"> <thead> <tr> <th>One-Third Octave-Band Number</th> <th>Nominal Center Frequency (Hz)</th> <th>One-Third Octave-Band Number</th> <th>Nominal Center Frequency (Hz)</th> </tr> </thead> <tbody> <tr><td>17</td><td>50</td><td>30</td><td>1,000</td></tr> <tr><td>18</td><td>63</td><td>31</td><td>1,250</td></tr> <tr><td>19</td><td>80</td><td>32</td><td>1,600</td></tr> <tr><td>20</td><td>100</td><td>33</td><td>2,000</td></tr> <tr><td>21</td><td>125</td><td>34</td><td>2,500</td></tr> <tr><td>22</td><td>160</td><td>35</td><td>3,150</td></tr> <tr><td>23</td><td>200</td><td>36</td><td>4,000</td></tr> <tr><td>24</td><td>250</td><td>37</td><td>5,000</td></tr> <tr><td>25</td><td>315</td><td>38</td><td>6,300</td></tr> <tr><td>26</td><td>400</td><td>39</td><td>8,000</td></tr> <tr><td>27</td><td>500</td><td>40</td><td>10,000</td></tr> <tr><td>28</td><td>630</td><td></td><td></td></tr> <tr><td>29</td><td>800</td><td></td><td></td></tr> </tbody> </table>	One-Third Octave-Band Number	Nominal Center Frequency (Hz)	One-Third Octave-Band Number	Nominal Center Frequency (Hz)	17	50	30	1,000	18	63	31	1,250	19	80	32	1,600	20	100	33	2,000	21	125	34	2,500	22	160	35	3,150	23	200	36	4,000	24	250	37	5,000	25	315	38	6,300	26	400	39	8,000	27	500	40	10,000	28	630			29	800		
One-Third Octave-Band Number	Nominal Center Frequency (Hz)	One-Third Octave-Band Number	Nominal Center Frequency (Hz)																																																						
17	50	30	1,000																																																						
18	63	31	1,250																																																						
19	80	32	1,600																																																						
20	100	33	2,000																																																						
21	125	34	2,500																																																						
22	160	35	3,150																																																						
23	200	36	4,000																																																						
24	250	37	5,000																																																						
25	315	38	6,300																																																						
26	400	39	8,000																																																						
27	500	40	10,000																																																						
28	630																																																								
29	800																																																								
<p><b>Operating Configuration</b></p>	<p>Operating configurations specify the pattern of aircraft arrivals and departures on specific runways depending on the weather conditions and airport capacity. Specifying configurations allows the user to assign aircraft to runways based on aircraft weight category criteria that is similar to those employed in an actual airport operating environment. Operating configurations are only used when the Delay &amp; Sequencing modeling option is enabled.</p>																																																								
<p><b>Overflight</b></p>	<p>A <b>flight operation</b> that starts and ends in airspace (i.e., not a runway end/helipad) with optional user-specified changes in altitude and speed during the flight.</p>																																																								
<p><b>Procedure Steps</b></p>	<p>A prescription for flying part of a profile. Procedures include climbing at constant <b>calibrated airspeed</b> to a given altitude in feet AFE, accelerating to a given airspeed while climbing at a given vertical rate, etc.</p>																																																								
<p><b>Pressure Ratio</b></p>	<p>The ratio of pressure to the <b>ISA</b> sea-level value.</p>																																																								
<p><b>Profile Points</b></p>	<p>The set of points that make up a <b>flight profile</b>. Profile points can be input directly into the AEDT or can be calculated by AEDT from a set of <b>procedure steps</b>.</p>																																																								
<p><b>°R</b></p>	<p>Degrees Rankine, which uses the Fahrenheit scale adjusted so that 0 degrees Rankine is equal to absolute zero.</p>																																																								
<p><b>Receptor</b></p>	<p>A receiver or grid point at which <b>noise</b>, time, or pollutant concentration values are computed.</p>																																																								



<b>Reference Day Conditions</b>	The atmospheric conditions corresponding to 77 degrees Fahrenheit (25 degrees Celsius), 70 percent relative humidity, and 29.92 in-Hg (760 mm-Hg). These are the atmospheric conditions to which aircraft <b>noise</b> certification data are corrected in accordance with 14 CFR Part 36 Section B36.7. These conditions are commonly referred to as <b>ISA plus 10 degrees Celsius (ISA+10)</b> .
<b>Reference Speed</b>	The <b>noise</b> -exposure reference speed in AEDT is 160 knots (KCAS). Thus, <b>L<sub>AE</sub></b> and <b>L<sub>EPN</sub></b> values in the <b>NPD</b> database are referenced to 160 <b>kts</b> . The <b>L<sub>ASmx</sub></b> , <b>L<sub>CSmx</sub></b> , and <b>L<sub>PNTSmx</sub></b> values are assumed to be independent of aircraft speed.
<b>Refraction</b>	Change in the direction of sound propagation as a result of spatial changes in the speed of sound in a medium.
<b>Refraction-Scattering Effects (or Air-to-Ground Attenuation)</b>	A component of the <b>lateral attenuation adjustment</b> that takes into account the effects of <b>refraction</b> and <b>scattering</b> as sound propagates through the air to the receiver as a function of <b>elevation angle</b> .
<b>Regular Grid</b>	A set of <b>receptor</b> points spaced at fixed intervals, over a specified area in the vicinity of the case airport.
<b>Runup</b>	An activity in which an aircraft is either conducting a pre-flight engine check (e.g., piston-powered aircraft) or testing engine operations on the ground. It is modeled in AEDT as an aircraft in a stationary position on the airport surface, with aircraft thrust held constant at a user-defined level for a set period of time.
<b>Scattering</b>	Irregular reflection or diffraction of sound in many directions.
<b>Senzig-Fleming-Iovinelli (SFI)</b>	Senzig-Fleming-Iovinelli (SFI) fuel consumption model refers to the SAE-AIR-6183 <sup>6</sup> terminal area fuel consumption standard.
<b>Simplified Adjustment Procedure</b>	An adjustment procedure used for developing NPD data from measured <b>noise</b> level data, which are used in AEDT. In contrast to the <b>integrated adjustment procedure</b> , the simplified adjustment procedure is based on <b>noise</b> -level data measured at the time of the <b>maximum noise level</b> only. In the simplified adjustment procedure, off-reference aircraft speed, <b>atmospheric absorption</b> , <b>distance duration</b> effects, and <b>spherical divergence</b> are considered. This adjustment procedure provides data consistent with Type 2 quality as defined in SAE-AIR-1845 <sup>3</sup> .
<b>Slant Range Distance (SLR)</b>	The line-of-sight distance between a receiver and a <b>flight path segment</b> .
<b>Sound Pressure Level (SPL)</b>	<p>Ten times the base-10 logarithm of the ratio of the <b>mean-square sound pressure</b>, in a stated frequency band, to the square of the reference sound pressure of 20 μPa, which is the threshold of human hearing.</p> $SPL = 10 \log_{10} \left[ \frac{p^2}{p_0^2} \right]$ <p>where</p> <p><math>p^2</math> Mean-square pressure (Pa<sup>2</sup>); and</p> <p><math>p_0</math> 20 μPa.</p>

<b>Sound Exposure (Noise Exposure)</b>	<p>The integral over a given time interval (<math>t_2 - t_1</math>) of the instantaneous, frequency-weighted, squared sound pressure:</p> $E_{12} = \int_{t_1}^{t_2} p^2(t) dt$ <p>where  <math>E_{12}</math>      Sound exposure (<math>\text{Pa}^2\text{s}</math>) over the time interval (<math>t_2-t_1</math>).</p>
<b>Sound Exposure Level</b>	<p>Ten times the base-10 logarithm of the <b>sound exposure</b> divided by a reference <b>sound exposure</b>.</p> $L_E = 10 \log_{10} \left[ \frac{E}{E_0} \right]$ <p>where  <math>E</math>            <b>Sound exposure</b> (<math>\text{Pa}^2\text{s}</math>);  <math>E_0</math>          <math>(20 \mu\text{Pa})^2</math> (1 s) for <b>A-weighted</b> and <b>C-weighted sound exposure</b>; and  <math>E_0</math>          <math>(20 \mu\text{Pa})^2</math> (10 s) for <b>tone-corrected perceived sound exposure</b>.</p>
<b>Sound Exposure Ratio</b>	<p>Commonly called “energy”. The ratio of <b>sound exposure</b> over a reference <b>sound exposure</b>, or ten raised to power of one tenth the <b>sound exposure level</b>:</p> $\frac{E}{E_0} = 10^{\frac{L_E}{10}}$ <p>where  <math>E</math>            <b>Sound exposure</b> (<math>\text{Pa}^2\text{s}</math>);  <math>E_0</math>          Reference <b>sound exposure</b> (<math>\text{Pa}^2\text{s}</math>); and  <math>L_E</math>         <b>Sound exposure level</b> (dB).</p>
<b>Source Noise Adjustment Due to Advancing Tip Mach Number</b>	<p>A <b>noise</b> adjustment based upon the change in <b>Mach</b> number of the advancing rotor blade of a helicopter. This adjustment is only applied during level flight segments, and accounts for airspeed, temperature and/or rotor RPM which deviate from helicopter-specific reference values.</p>
<b>Speciated Organic Gas (SOG)</b>	<p>A specific molecular species whose total mass is based on a fraction of TOG mass. AEDT reports up to 44 IRIS-listed SOGs and up to 394 non-IRIS SOGs, depending on aircraft engine type and GSE fuel type.</p>
<b>Spectrum</b>	<p>A set of sound pressure levels in component frequency bands, usually one-third octave bands.</p>
<b>Spectral Class</b>	<p>A set of aircraft spectra which are grouped together based on similar spectral characteristics for similar operational modes.</p>

<b>Spherical Divergence</b>	Spherical divergence, which is taken into account in the AEDT <b>NPD</b> data, is defined as the transmission loss of <b>mean-square sound pressure</b> , which varies inversely with the square of the distance from a point source. In contrast, cylindrical divergence is the transmission loss of <b>mean-square sound pressure</b> , which varies inversely with distance from a line source.
<b>Stage Length</b>	A range of trip lengths/distances for departure profiles.
<b>Standard Day Conditions</b>	The atmospheric conditions corresponding to 59 degrees Fahrenheit (15 degrees Celsius), 70% relative humidity, and 29.92 in-Hg (760 mm-Hg). The values for temperature and atmospheric pressure are sea-level conditions for the <b>ISA</b> .
<b>Static Directivity Adjustment</b>	Refer to <b>Directivity Adjustment</b> .
<b>Static Operation</b>	A stationary aircraft operation. Runup operations are the only kind of static operations available for fixed-wing aircraft in AEDT. There are four kinds of static operational modes for helicopters in AEDT: <b>flight idle</b> , <b>ground idle</b> , <b>hover in ground effect</b> , and <b>hover out of ground effect</b> . Static helicopter operations are utilized in conjunction with a <b>static directivity adjustment</b> .
<b>Static Operation Duration Adjustment</b>	Refer to <b>Duration Adjustment</b> .
<b>Static Thrust</b>	Maximum thrust (lbs) produced by a stationary engine at sea-level, <b>ISA</b> conditions.
<b>Statistical Compression</b>	A method used to adjust TAUD to account for the effects of simultaneously occurring aircraft events on audibility. Also known as the overlapping events method.
<b>Temperature Deviation</b>	The difference between the temperature at a given location and time and the corresponding temperature in another atmosphere at the same location and time.
<b>Temperature Ratio</b>	The ratio of temperature to the <b>ISA</b> sea-level value.
<b>Thrust Reverser Adjustment</b>	An empirically-derived <b>noise</b> adjustment to account for <b>noise</b> from thrust reverser deployment during the landing ground roll.
<b>Thrust-Specific Fuel Consumption (TSFC)</b>	The flow rate of fuel (mass/time) consumed by an engine per unit of thrust (force) produced by that engine. TSFC is a measure of the efficiency of the engine, with smaller values indicating higher efficiency.
<b>Time-Above</b>	The duration that a time-varying sound level is above a given sound level threshold.
<b>Time Audible</b>	The duration that a time-varying sound level may be detected in the presence of ambient noise as audible by a human observer with normal hearing, who is actively listening for aircraft noise.

<p><b>Time-Averaging Constant</b></p>	<p>A constant <b>decibel</b> value that is ten times the base-10 logarithm of the time interval associated with the metric divided by a reference time interval, which is usually one second. The time-averaging constant is equal to:</p> $\text{Time – Averaging Constant} = 10\log_{10}[N_T]$ <p>where</p> $N_T = \frac{T_i}{T_{ref}};$ <p><math>T_i</math> Time interval associated with a particular metric (s); and  <math>T_{ref}</math> Reference time interval (s).</p> <p>Using <math>L_{dn}</math> as an example, <math>T_i</math> is 86,400 seconds in 24 hours, <math>T_{ref}</math> is 1 second, and the time-averaging constant is 49.37 <b>dB</b>. The time-averaging constant is subtracted from the <b>sound exposure level</b> to compute an equivalent or average sound level.</p>
<p><b>Tone-Corrected Perceived Noise Level</b></p>	<p>Tone-corrected perceived <b>noise</b> levels are used to estimate human-perceived <b>noise</b> from broadband sound sources, such as aircraft, which contain pure tones or other major irregularities in their frequency spectra. It is calculated by applying an adjustment to the <b>noise</b> level that is related to the degree of irregularity that may occur among contiguous one-third octave band sound pressure levels of aircraft <b>noise</b>, as described in 14 CFR Part 36<sup>26</sup>.</p>
<p><b>Touch and Go (TGO)</b></p>	<p>A flight operation that begins with a level flight in the terminal control area, descends and lands on an airport runway, and then takes off immediately after landing and returns to level flight.</p>
<p><b>True Airspeed (TAS)</b></p>	<p>The speed of an aircraft relative to its surrounding air mass. The standard aviation abbreviation “KTAS” is used when the units are knots.</p>
<p><b>Weighting Factor</b></p>	<p>A numeric value that multiplies the <b>sound exposure ratio</b> associated with a time period for a given metric. For the exposure-based metrics, the weighting factor acts as a penalty for operations that occur during a specific time period. Usually larger penalties are applied during the night-time period when people are most sensitive to <b>noise</b>. For the maximum-level and time-based metrics, the weighting factors are either zero or unity. As such, they act as a binary switch allowing the user to select specific time periods for computation.</p>

## 1.5 Abbreviations

A term in bold indicates that it is defined in the Terminology or Abbreviations table.

<b>AEDT</b>	Aviation Environmental Design Tool
<b>AEE</b>	FAA Office of Environment and Energy
<b>AFE</b>	Above Field Elevation
<b>AGL</b>	Above Ground Level
<b>AFR</b>	Air-to-Fuel Ratio
<b>AIR</b>	Aerospace Information Report (SAE-AIR)
<b>ANP</b>	Aircraft Noise and Performance Model. Refer to Section 2.1.4.
<b>APEX</b>	Aircraft Particle Emissions eXperiment. Refer to Section 5.1.1.2.
<b>APU</b>	Auxiliary Power Unit
<b>ASIF</b>	AEDT Standard Input File
<b>BADA 3</b>	Base of Aircraft Data 3. Refer to Section 3.2.
<b>BADA 4</b>	Base of Aircraft Data 4. Refer to Section 12.3.
<b>BFFM2</b>	Boeing Fuel Flow Method 2. Refer to Section 5.1.1.1. BFFM2 is part of the SAE-AIR-6183 <sup>6</sup> terminal area fuel consumption standard.
<b>BTU</b>	British Thermal Unit
<b>°C</b>	Degrees Celsius (temperature)
<b>CAEP</b>	ICAO Committee on Aviation Environmental Protection
<b>CAS</b>	Calibrated Air Speed
<b>CPA</b>	Closest Point of Approach
<b>CO</b>	Carbon Monoxide
<b>CO<sub>2</sub></b>	Carbon Dioxide
<b>CI</b>	Concentration Index
<b>dB</b>	Decibel
<b>EASN</b>	Equivalent Auditory System Noise
<b>ECAC</b>	European Civil Aviation Conference
<b>EDMS</b>	Emissions and Dispersion Modeling System
<b>EEDB</b>	International Civil Aviation Organization (ICAO) Engine Emissions Databank
<b>EI</b>	Emissions index
<b>EPA</b>	United States Environmental Protection Agency
<b>EUROCONTROL</b>	European Organization for the Safety of Air Navigation
<b>°F</b>	Degrees Fahrenheit (temperature)
<b>FAA</b>	United States Federal Aviation Administration
<b>FAR</b>	Federal Aviation Regulation
<b>ft</b>	Feet
<b>FOA</b>	First Order Approximation
<b>FSC</b>	Fuel Sulfur Content

<b>FSL</b>	Forecast Systems Laboratory
<b>GIS</b>	Geographic Information System
<b>GSE</b>	Ground support equipment
<b>GUI</b>	Graphical User Interface
<b>HAP</b>	Hazardous Air Pollutant
<b>HIGE</b>	Hover In Ground Effect
<b>HOGE</b>	Hover Out of Ground Effect
<b>IATA</b>	International Air Transport Association
<b>ICAO</b>	International Civil Aviation Organization
<b>In-Hg</b>	Inches of Mercury (barometric pressure)
<b>INM</b>	Integrated Noise Model
<b>ISA</b>	International Standard Atmosphere
<b>KCAS</b>	Knots, calibrated airspeed
<b>km</b>	Kilometers
<b>kt, kts</b>	Knots (international nautical miles per hour)
<b>KTAS</b>	Knots, true airspeed
<b>L<sub>AE</sub></b>	A-weighted sound exposure level (SEL)
<b>L<sub>ASmx</sub></b>	Maximum A-weighted sound level with slow-scale exponential time weighting (LAMAX)
<b>L<sub>CE</sub></b>	C-weighted sound exposure level (CEXP)
<b>L<sub>CSmx</sub></b>	C-weighted maximum sound level with slow-scale exponential weighting characteristics (LCMAX)
<b>L<sub>EPN</sub></b>	Effective tone-corrected perceived noise level (EPNL)
<b>L<sub>PNTSmx</sub></b>	Maximum tone-corrected perceived noise level with slow-scale exponential time weighting (PNLTM)
<b>lb</b>	Weight
<b>lbf</b>	Pounds force
<b>LTO</b>	Landing and Takeoff
<b>m</b>	Meters
<b>MOVES</b>	Motor Vehicle Emission Simulator
<b>MSL</b>	Mean Sea Level
<b>N</b>	Newtons
<b>NAAQS</b>	National Ambient Air Quality Standards
<b>NASA</b>	National Aeronautics and Space Administration
<b>NCDC</b>	NOAA National Climactic Data Center, now the National Centers for Environmental Information (NCEI)
<b>NCEI</b>	NOAA National Centers for Environmental Information
<b>NEPA</b>	National Environmental Policy Act
<b>NMHC</b>	Non-Methane Hydrocarbons

<b>nmi</b>	International Nautical Miles (1,852 m)
<b>NO<sub>2</sub></b>	Nitrogen Dioxide
<b>NO<sub>x</sub></b>	Nitrogen Oxides
<b>NOAA</b>	National Oceanic and Atmospheric Administration
<b>NPD</b>	Noise-Power-Distance
<b>nvPM</b>	Non-Volatile Particulate Matter
<b>NWS</b>	National Weather Service
<b>Pa</b>	Pascal (unit of pressure, one Newton per square meter)
<b>PCHIP</b>	Piecewise Cubic Hermite Interpolating Polynomial
<b>PCPA</b>	Perpendicular Closest Point of Approach
<b>PIT</b>	Population Import Tool
<b>PM</b>	Particulate Matter
<b>PM<sub>10</sub></b>	Particulate matter less than or equal to 10 micrometers in aerodynamic diameter
<b>PM<sub>2.5</sub></b>	Particulate matter less than or equal to 2.5 micrometers in aerodynamic diameter
<b>°R</b>	Degrees Rankine
<b>ROC</b>	Rate of Climb
<b>s, sec</b>	Second (time duration)
<b>SAE</b>	Society of Automotive Engineers
<b>SLR</b>	Slant Range Distance
<b>SN</b>	Smoke Number
<b>SOG</b>	Speciated Organic Gas
<b>SO<sub>2</sub></b>	Sulfur Dioxide
<b>SO<sub>x</sub></b>	Sulfur Oxides
<b>SPL</b>	Sound Pressure Level
<b>TAS</b>	True Air Speed
<b>THC</b>	Total Hydrocarbons
<b>TOC</b>	Total Organic Compounds
<b>TOG</b>	Total Organic Gases
<b>TSFC</b>	Thrust-Specific Fuel Consumption
<b>VOC</b>	Volatile Organic Compounds

## 2. Data

### 2.1 AEDT Databases

#### 2.1.1 Overview

The central data architecture of AEDT relies on a relational database management system (Microsoft SQL Server<sup>ii</sup>). There are two tiers in the architecture, a foundation comprised of two system provided databases (Airport and Fleet), and a superstructure (Study) for end user content management.

The two AEDT system databases, Airport and Fleet, define the relational data storage, referred to as a schema. They contain the geographic and source information for airport and equipment elements necessary to populate required parameters in the underlying environmental models – e.g., aerodynamic, emissions, and structural coefficients for both aircraft and non-aircraft equipment, external reference codes from standard aviation sources, runway and helipad data, historical meteorological values, etc.

The superstructure, generally referred to as Study, replicates a combined schema of the system databases and adds structure in the form of additional relational schema to establish a repository for operational inputs, results storage, user-defined elements, and graphical representations for a given analysis. A template Study database schema exists as the point of origin for creating a new study. Whenever a new study is created, typically using the graphical user interface, data desired by the user is retrieved from the system database(s) and placed into the new instance of a study database.

The concept of relational database management extends beyond just data storage to include a programmable engine for data storage and retrieval, enterprise storage platforms for scalability, and external access to input and output data.

The AEDT database schema is an open standard with respective database description documents for the three defined databases:

- Study: Baseline format for creating and importing a new study;
- Airport: Global set of airport-specific data using standard FAA, International Civil Aviation Organization (ICAO), and International Air Transport Association (IATA) codes; and
- Fleet: Data for all available equipment, both aircraft and non-aircraft, used in the performance, emissions, and noise environmental models.

#### 2.1.2 Study Database

The AEDT Study database contains all information, or references to external source data (weather, terrain, ambient, and map layers), including input and configuration, intermediate data, and output results for the AEDT application. A schematic representation of the database (called entity relationship diagram) is available with the AEDT installation (Study\_ERD.pdf). The diagram highlights the structures

---

<sup>ii</sup> AEDT 3g supports Microsoft SQL Server 2022.



---

three main data areas (airport, fleet, and operations). Further, the diagram places the constellation of user settings, metric results constructs, and user-defined content such as equipment and airport configurations, and grouping and annualization of operations.

Any given study may contain one or more airports, each with one or many layouts, and each layout may have one or more operating configurations, e.g., north-flow or west-flow. AEDT's calculation of metric results is flexible enough to incorporate operations located at any of the airports included in the study. The relational links between operations and the airport(s) where those operations take place are maintained in the study.

Further, in developing any given study, one or more years (future or past) can be included and applied on a per metric result (output) basis. Individual airport layouts can be time constrained, if desired, to a time period and operations which may span larger time periods will be filtered by the system when creating metric results. A common design for a study is the construct of a present airport layout and a future airport layout with respective operations for each layout. The metric results for each layout can then be compared to identify improvements in the environmental consequences of the new design.

The information defined in the Study database is available in the Study Database Description Document (Study DDD)<sup>10</sup>. The Study DDD specifies all parameter types and units, table structure (grouping of parameters), and the relational links between tables, i.e., the database schema.

### 2.1.3 Airport Database

The AEDT Airport database consists of tables containing a global set of airports and airport data such as runways, historical atmospheric conditions, and time zones.

An AEDT study contains airport data from the Airport database. As noted in Section 2.1.1, the airport tables are populated with data pertinent to the airports referenced in the study. The initial population of the airport tables in a study database are a subset of the records contained in the Airport database:

1. ICAO and IATA airport codes including their time history of changes.
2. Historical averages of meteorological data from weather sensors (where available).
3. Airport surface structures, e.g., runways, taxiways, gates, buildings, etc.
4. Airspace geographical content on procedures, e.g., ground-tracks, altitude controls, etc.

Once the study database is established, additional detail about a given airport can be created or modified through the graphical user interface, an ASIF, or directly in the SQL database. Further, if additional airports are desired after an initial set of airports are chosen, they can be added to the study using the graphical interface functions.

The information defined in the Airport database is available in the Airport Database Description Document (Airport DDD)<sup>11</sup>. The Airport DDD specifies all parameter types and units, table structure (grouping of parameters), and the relational links between tables, i.e., the database schema.

### 2.1.4 Fleet Database

The AEDT Fleet database contains tables that store aircraft and non-aircraft equipment related information for use by the AEDT system. The AEDT Fleet database tables are relationally linked and each falls into three tiers of aircraft data – physical, modeling, and type.

The Fleet database contains over 3,500 aircraft (airframe/engine combinations) and approximately 400 non-aircraft emissions sources (ground support equipment, stationary power and fuel equipment, and auxiliary power units).

The modeling tier contains aircraft modeling parameters specific to the four aircraft representations used to evaluate the environmental impacts of interest in AEDT. These four models are:

1. ICAO Engine Emissions Databank<sup>12</sup> (EEDB);
2. ICAO Aircraft Noise and Performance Database<sup>13</sup> (ANP);
3. EUROCONTROL Base of Aircraft Data Family 3 (BADA 3)<sup>20</sup>; and
4. EUROCONTROL BADA Family 4 (BADA 4)<sup>14</sup>.

The aircraft in the physical tier are assigned links to aircraft representations from each of the four models in the modeling tier. This mapping effectively condenses the fleet of physical aircraft into a modeling set of over 3,500 equipment records.

The type tier is the most abstract layer of the Fleet database. This representation is based on the ICAO Aircraft Type document, ICAO 8643<sup>15</sup>, and the IATA Aircraft Type Table<sup>16</sup>. These Types address aircraft at the airframe level and are typically used by, for example, air traffic management systems to reference aircraft in schedule and operational records.

The non-aircraft emissions sources are available for use in modeling emissions and emissions dispersion metrics. The non-aircraft equipment are stored in hierarchical tables that separate the sources into categories according to the physical mechanisms of their respective emissions, e.g., combustion, evaporation, wind/run-off, etc. The set of system provided non-aircraft equipment is available for assignment to operations in two ways, either as stand-alone operations or associated with (and therefore proportional to) aircraft operations.

The information defined in the Fleet database is available in the Fleet Database Description Document (Fleet DDD)<sup>17</sup>. The Fleet DDD specifies all parameter types and units, table structure (grouping of parameters), and the relational links between tables, i.e., the database schema.

### 2.1.5 Equipment Operations (Study)

The central construct in an AEDT Study is equipment operations. Operations can be specified in, broadly, two modes. Either as an explicitly scheduled operation where the minimum required information for the operation is the equipment to be used, the time at which the operation is to take place, and the location of the operation. Or, as an operational (time) profile where again the equipment and location of the operation must be specified by the user, but the time component is an activity profile over an entire

model year. The activity profile is the combination of three, hour-of-day/day-of-week/month-of-year, distributions that are applied by the system to form an annual explicit schedule.

The minimum information on the two forms of operations (activity profile and explicit schedule) can be further augmented with, where available or created by the user, additional geographic, temporal, and logical information. For example, track geometry and controls can be applied to the aircraft operations. Gate and taxipath information can be applied to non-aircraft and aircraft operations. If even more detail is available, the desired trajectory or sensor path can be assigned to an aircraft operation.

These two operations forms are encapsulated in the AIR\_OPERATION and STN\_OP tables found in the Study database. The relational links between the equipment, location/geometry of the operation, and the time or activity profile are maintained within the Study database explicitly and do not relate back to the system Airport and Fleet databases.

### **Aircraft Operations**

The root data for scheduled operation are records in the AIR\_OPERATION table of the Study database. Each record links, at minimum, to an aircraft equipment record (FLT\_EQUIPMENT), an airport layout record (AIRPORT\_LAYOUT), and an operation type and count, e.g., departure, arrival, overflight, etc. For any operation record, additional information about the operation can be linked to and/or set in the record. The comprehensive list of optional and additional fields for the operation record are as follows:

- [USER\_ID]
- [AIR\_OPERATION\_DETAIL\_ID]
- [OPERATION\_TIME] or [ACTIVITY\_PROFILE]
- [PROFILE] or [STAGE\_LENGTH] or [AIRPORT\_PAIR]
- [DEPARTURE\_RUNWAY\_END] or [ARRIVAL\_RUNWAY\_END] or [TRACK] or [SENSOR\_PATH]
- [ARRIVAL\_GATE\_ID] or [DEPARTURE\_GATE\_ID]
- [TAXI\_OUT\_TIME] or [TAXI\_IN\_TIME]
- [CRUISE\_ALTITUDE] (pressure altitude in feet)

Each of these fields can be addressed through the graphical user interface, an ASIF, or directly in the SQL database. As noted above the field-level definitions for each item in this list is available in the Study DDD.

### **Non-Aircraft Operations (Activity Profile Only)**

The root data for non-aircraft operations are stored in the STN\_OP table of the Study database. Each record links, at minimum, to a non-aircraft equipment record (STN\_SOURCE table), an airport layout record (AIRPORT\_LAYOUT table), an activity profile record (APTPROFILE\_ACTIVITY\_PROFILE table) and an annual (or peak) operation count. For any non-aircraft operation record, additional information about the operation can be linked to and/or set in the record. The non-aircraft operation record can

optionally specify a geographic location at which stationary emissions sources are located with the three additional fields: [ELEVATION], [LATITUDE], and [LONGITUDE].

The location fields can be addressed through the graphical user interface, an ASIF, or the SQL database in the same way that Aircraft Operations details are exposed. As noted above, these three field definitions are available in the Study DDD.

## 2.2 Input Data

### 2.2.1 Summary of Input Data for Noise Computation

The AEDT Fleet database contains noise vs. power vs. distance acoustic data (or noise vs. operational mode vs. distance data for helicopters), augmented by a database of spectral characteristics (known as spectral classes) and additional aircraft-specific data to support several noise adjustments available in AEDT.

#### 2.2.1.1 Noise-Power-Distance (NPD) Data Sets

The noise vs. power vs. distance acoustic data (or noise vs. operational mode vs. distance data for helicopters) in AEDT, also referred to as NPD data, represent the aircraft source noise level for a given operational mode and power setting at a range of slant distances from the aircraft to account for acoustic propagation through a standard atmosphere. There are two types of NPDs in AEDT: fixed wing aircraft NPDs (for all commercial and military fixed wing aircraft), and helicopter NPDs. The NPD data for fixed-wing aircraft consist of a set of decibel (dB) levels for various combinations of aircraft operational modes, engine power settings, slant distances from aircraft to receptor, and base noise metrics that are associated with a specific aircraft engine. The NPD data for helicopters consist of a set of decibel levels for various combinations of aircraft operational modes, slant distances from aircraft to receptor, and base noise metrics that are associated with a specific helicopter engine. These data are usually obtained from the AEDT Fleet database, but they can also be user-defined. These commercial fixed-wing aircraft NPD data are also consistent with the EUROCONTROL ANP database<sup>iii13</sup>.

An underlying assumption is that NPD data represent an aircraft proceeding along a straight flight path of infinite length and parallel to the ground through a standard atmosphere. Differences from this assumption, such as curved flight tracks and climbing/descending flight profiles, are accounted for by adjustments to the NPDs.

NPDs represent the source noise for a specific aircraft. A decibel level on an NPD includes the noise generated by the airframe and all engines<sup>iv</sup>. For helicopters, NPDs also includes rotor noise.

For fixed wing aircraft, each NPD is associated with an engine power setting, also known as thrust setting. NPDs at different power settings represent the different types of noise generated by those

---

<sup>iii</sup> The ANP NPD database does not include military or helicopter data.

<sup>iv</sup> It is important to note that although engine power setting for a NPD is expressed on a per engine basis, the corresponding noise level on the NPD represents all engines on the aircraft.

power settings. Engine power setting is expressed on a per engine basis in a variety of units, as listed in Table 2-1. For helicopters, NPDs are not associated with an engine power setting and are associated with a helicopter operational mode instead.

Table 2-1 Engine Power Setting Units

Engine Power (Thrust) Setting	Description	Units
Pounds	Corrected net thrust per engine	Pounds force
TurbineInletTemperatureDegC	Turbine inlet temperature	Degrees Celsius
EnginePressureRatio	Engine pressure ratio	Dimensionless
EquivalentShaftPower	Equivalent shaft power	Horsepower
ManifoldPressureInHg	Manifold pressure	Inches of mercury
PoundsPerHourFuelFlow	Fuel mass flow rate	Pounds per hour
Percent	Percent of ISA sea-level static thrust	Percent (dimensionless)
PercentCorrectedRotorSpeed	Percent of maximum corrected rotor design speed	Percent (dimensionless)
FanSpeed	Fan speed	Rotations per minute
PercentFanSpeed	Percent of fan design speed	Percent (dimensionless)
PercentLowPressureCompressorSpeed	Percent of low pressure compressor design speed	Percent (dimensionless)
PowerLeverAngle	Power lever angle	Degrees (in decimals)
PercentPropellerOrCompressorRPM	Percent of propeller or compressor design speed	Percent (dimensionless)
PropellerOrCompressorRPM	Propeller or compressor speed	Rotations per minute

Different operational modes generate different types of noise. Typically, departure operations may be dominated by engine noise, whereas approach operations may be dominated by airframe noise. To account for these differences, NPDs are also delineated by operational mode. For fixed-wing aircraft, NPD data consist of two or more noise curves for each operational mode. Operational modes are sub-categories of phases of modeled flight. Refer to Table 2-2 for a complete list of fixed-wing aircraft operational modes.

Helicopter NPD data consist of noise curves for each operational mode procedural step. While helicopters use the same general operational mode types as fixed-wing aircraft (approach, departure and level flight), AEDT further delineates helicopter operational mode to include a variety of different types of procedural steps. The NPD data for a helicopter, either from the AEDT Fleet database or user-defined, are organized according to dynamic operation modes (departure, approach, overflight, accelerate, decelerate, etc.) and static operational modes (ground idle, flight idle, hover in and out of ground effect). Refer to Table 2-2 and Table 2-3 for a complete list of fixed-wing aircraft and helicopter operational mode procedure steps.

Table 2-2 Operational Mode for Each Fixed-Wing Aircraft NPD Data Set

Operational Mode	Description
A	Approach
D	Departure
L	Level flight

Table 2-3 Operational Mode Procedure Steps for Each Helicopter NPD Data Set

Operational Mode	Description	State
A	Approach at constant speed	Dynamic
D	Departure at constant speed	Dynamic
L	Level flyover at constant speed	Dynamic
G	Ground idle	Static
H	Flight idle	Static
I	Hover in ground effect	Static
J	Hover out of ground effect	Static
V	Vertical ascent in ground effect	Static
W	Vertical ascent out of ground effect	Static
Y	Vertical descent in ground effect	Static
Z	Vertical descent out of ground effect	Static
B	Approach with horizontal deceleration	Dynamic
C	Approach with descending deceleration	Dynamic
E	Depart with horizontal acceleration	Dynamic
F	Depart with climbing acceleration	Dynamic
T	Taxi at constant speed	Dynamic

Each NPD includes aircraft noise levels at the following ten distances: 200; 400; 630; 1,000; 2,000; 4,000; 6,300; 10,000; 16,000; and 25,000 ft. The propagation of aircraft noise under standard conditions is represented by NPDs in AEDT. The noise levels in the NPD data (for all aircraft types) have been adjusted for time-varying aircraft speed (exposure-based noise levels only), atmospheric absorption, distance-duration effects (if the simplified adjustment process is used for exposure-based noise levels)<sup>v</sup>, and spherical divergence to each of the ten distances in accordance with the methodology presented in Reference 3 and summarized in Reference 19.

Each set of NPDs in the database includes separate NPDs for four different base noise metrics:

<sup>v</sup> A specific adjustment is used to account for distance-duration effects computed with the simplified adjustment process. For military aircraft, NPD data were developed using the simplified data adjustment procedure, and distance duration effects were computed using an empirically-derived  $6.0 \log_{10}[d/d_{ref}]$  relationship. In contrast, NPD data for civilian aircraft that were corrected using the simplified procedure were adjusted using an empirically-derived  $7.5 \log_{10}[d/d_{ref}]$  relationship. It was decided that the 6-log relationship would be maintained for the military aircraft in AEDT, since it represents a best-fit empirical relationship for those aircraft.

---

$L_{AE}$	A-weighted sound exposure level (SEL);
$L_{ASmx}$	Maximum A-weighted sound level with slow-scale exponential time weighting (LAMAX);
$L_{EPN}$	Effective tone-corrected perceived noise level (EPNL); and
$L_{PNTSmx}$	Maximum tone-corrected perceived noise level with slow-scale exponential time weighting (PNLTM).

All metrics in AEDT, including C-weighted and time-based metrics, are computed using these four base noise level metrics.

For fixed-wing aircraft, noise levels that lie between thrust values or between distance values are obtained by linear interpolation on thrust and logarithmic interpolation on distance. Extrapolation is used to obtain levels outside of the bounding thrust or distances values, see Section 4.2.2. For helicopters, no interpolation is performed between multiple operational modes

While the underlying databases for fixed-wing aircraft, helicopters, and military aircraft are based on the same data format (NPDs in conjunction with spectral data), there are several key differences in the AEDT Fleet database between helicopter and fixed-wing NPDs that warrant a more detailed description. The helicopter NPDs main differences are that:

- They are delineated according to operational mode instead of thrust/power setting;
- No interpolation is performed between multiple operational modes;
- For the dynamic operational modes they come in sets of three curves to represent helicopter noise lateral directivity; and
- For static operational modes each single NPD curve is paired with a helicopter-specific directivity adjustment to represent helicopter noise directivity.

For dynamic operational modes, there are three sets of noise levels for various combinations of helicopter operational modes (instead of thrust levels) at the ten standard distances. This set of three NPD curves is used to account for the asymmetrical directivity associated with helicopter noise; the three curves correspond to noise levels at locations directly below the helicopter (center) and at approximately 45 degrees to either side (left/right) of the centerline. For static operational modes, there is a single set of noise levels for various combinations of helicopter operational modes and slant distances from the helicopter to receptor. This single set of NPD curves is used in conjunction with a helicopter-specific directivity adjustment to account for static operational mode directivity (see Section 2.2.1.3).

### 2.2.1.2 Spectral Data Sets

The spectral data in AEDT consist of a set of sound pressure level vs. one-third octave-band frequency (50 Hz to 10 kHz) values measured at the time of  $L_{ASmx}$  or  $L_{PNTSmx}$  and corrected to a reference distance of 1,000 ft (305 m) using the SAE-AIR-1845<sup>3</sup> atmospheric absorption coefficients. These spectral data are used in AEDT to compute the following:

- Atmospheric absorption adjustment based on local temperature and relative humidity;
- Line-of-sight blockage adjustment due to terrain; and
- C-weighted noise metrics.

AEDT does not support a separate spectrum for each aircraft and operational mode. Instead, the spectral data in AEDT are in the form of spectral classes, which represent the spectral shape at time of maximum sound level for a group of aircraft deemed to have similar spectral characteristics for each different operation mode (approach, departure, level flight/afterburner). Sensitivity and validation tests were conducted on aircraft to identify appropriate spectral class groupings<sup>18</sup>.

The spectral class data was originally developed for the FAA's INM<sup>18</sup>. During the initial development process, aircraft were grouped together by engine type and/or number of engines (i.e., low-bypass ratio jet, high-bypass ratio jet, four engine jet, turboprop, piston, etc.); the groups were then broken down further by spectral shape. Some groups were partitioned further to eliminate the presence of widely used aircraft in the same group. For instance, aircraft that often fly similar missions (e.g., medium-range, narrow-body, commercial jet aircraft) may be placed in separate groups, even though their spectral shapes are similar, because of differences in engine type and engine placement/configuration on the aircraft. Aircraft added since the initial development were assigned to a spectral class using a series of tests to determine the class which provided the best fit. The best fit was based on spectral shape and similarities in atmospheric absorption calculations over the ten NPD slant distances for five different temperature and humidity conditions<sup>vi</sup> and line-of-sight blockage calculations over the ten NPD slant distances for seven path length differences<sup>vii</sup>, rather than on aircraft type (although in the majority of cases, the best fit spectral class proved to contain aircraft of similar types). The spectral class assignment process is documented in Section 11.2.2.

Similar spectral data for military aircraft from the Noisefile Database in the United States Air Force NOISEMAP computer program<sup>28</sup> are included in AEDT. NOISEMAP is used for computing noise exposure at facilities dominated by military operations. The military data also exist in the form of one-third octave-band spectra measured at the time of LASmx. These data were corrected to a distance of 1,000 feet (305 meters) using the SAE-AIR-1845<sup>3</sup> atmospheric absorption coefficients to maintain similarity with the referenced report<sup>19</sup>.

Once the spectra were grouped together, a representative spectrum was determined for the group. The spectrum was calculated from a departure-weighted arithmetic average of the individual aircraft spectra in the group for commercial aircraft. For military aircraft, aircraft inventory data were collected and each spectral class was represented by the single military aircraft which had the highest number in physical fleet inventory. Some single- and twin-engine turboprops and turbojets (i.e., business jets) have

---

<sup>vi</sup> The 5 temperature and humidity conditions used in the atmospheric absorption calculations are the SAE standard atmosphere and the 4 extremes for the Annex 16<sup>65</sup> allowable test window.

<sup>vii</sup> The 7 path length differences used in the line-of-sight blockage calculations are -1.2, 0, 1.2, 2.4, 3.6, 6.1, and 31 meters.



---

commercial, military, and private usages. For these aircraft, the representative spectrum was calculated using an equally weighted arithmetic average of all of the individual aircraft spectra.

AEDT allows for the definition and use of user-created spectral data. Data can be imported via the ASIF partial-import mechanism and each set of spectra require a designation of the applicable operational mode(s) (departure, approach, level/afterburner). In order to distinguish user-defined spectra from system data the spectral class identifiers are required to be in the range 20,000 – 30,000 (inclusive). Further details on the specific format are provided in the ASIF Reference Manual<sup>24</sup>.

### **2.2.1.3 Helicopter Static Directivity Data Sets**

The AEDT Fleet database includes directivity data for modeling noise from helicopter static operations (ground idle, flight idle, hover-in-ground-effect (HIGE), and hover-out-of-ground-effect (HOGE)). The static directivity data account for changes to the sound level as a function of the helicopter azimuth angle, which is measured clockwise from the nose of the helicopter. These data are based on empirical measurements, and account for relative differences in sound level at 15-degree increments around the helicopter at a nominal radial distance of approximately 200 ft. Many helicopters in the AEDT Fleet database have both acoustically hard and soft ground directivity data.

### **2.2.1.4 Helicopter Operational Mode Adjustment**

Although the AEDT database has the capability to include NPDs representing 16 different operational mode procedure steps, many helicopters in the database do not have a complete set of NPDs representing all of these procedure steps. In cases where NPDs do not exist in the AEDT database to model a procedure step for a particular helicopter, existing NPDs may be modified with a helicopter operational mode adjustment specific for that helicopter. For each helicopter in the AEDT database, there are six helicopter operational mode adjustments: vertical ascent (Vert Asc), vertical descent (Vert Dec), depart with horizontal acceleration (Accel Hor), approach with horizontal deceleration (Decel Hor), depart with climbing acceleration (Accel Clm), and approach with descending deceleration (Decel Dsc). These adjustments are in decibels, and they are applied as straight additions to the existing NPD levels. These offsets are applied to A-weighted, C-weighted and P-weighted NPDs at all distances. The operational mode procedure step data substitutions, including the appropriate helicopter operational mode adjustment, are presented in Table 2-4. While all standard AEDT helicopters have these six parameters set to zero, user-defined helicopters may use these adjustments.

Table 2-4 Substitution Operational Mode Procedure Steps Data for Helicopters, including the Appropriate Helicopter Operational Mode Adjustment

Missing Operational Mode Procedure Step Data	Available Operational Mode Procedure Step Data + Helicopter Operational Mode Adjustment
Ground idle (G)	Flight idle (H)
Flight idle (H)	Ground idle (G)
Hover in ground effect (I)	Hover out of ground effect (J)
Hover out of ground effect (J)	Hover in ground effect (I)
Vertical ascent in ground effect (V)	Hover in ground effect (I) + Vert Asc Adjustment
Vertical ascent out of ground effect (W)	Hover out of ground effect (J) + Vert Asc Adjustment
Vertical descent in ground effect (Y)	Hover in ground effect (I) + Vert Des Adjustment
Vertical descent out of ground effect (Z)	Hover out of ground effect (J) + Vert Des Adjustment
Approach with horizontal deceleration (B)	Approach (A) + Decel Hor Adjustment
Approach with descending deceleration (C)	Approach (A) + Decel Des Adjustment
Depart with horizontal acceleration (E)	Departure (D) + Accel Hor Adjustment
Depart with climbing acceleration (F)	Departure (D) + Accel Clm Adjustment
Taxi at constant speed (T)	Flight idle (H), if it has wheels Hover in ground effect (I), if it does not have wheels

### 2.2.1.5 Helicopter Speed Coefficients

AEDT does not account for noise changes due to helicopter speed in the same manner as it does for fixed-wing aircraft. Since AEDT only has a single set of level flight NPDs for each helicopter that is referenced to a single speed, the helicopter speed coefficients are used to adjust level flyover noise as a function of helicopter forward speed, which causes a difference in rotor tip Mach number for the advancing vs. receding blades. This speed adjustment, known as source noise adjustment due to advancing tip Mach number, is only applied to level flight operations. Separate speed coefficients are provided for the left, center and right NPDs, resulting in different source noise adjustments due to advancing tip Mach number for each NPD. The source noise adjustment due to advancing tip Mach number is described in more detail in Section 4.5.1.

### 2.2.1.6 Receptor Information

Information about receptor locations is required for noise computations. AEDT receptor locations are expressed as either regularly spaced grids (rasters in GIS language), point or population centroids (vectors in GIS language), or dynamic grids (a collection of raster blocks built up by the system). The receptor locations for a regular grid are defined by the location of the lower-left corner of the grid (latitude, longitude), the distance between grid points in the two directions (feet), the number of grid points in the two directions, and the angle that the grid is rotated relative to the x,y axes (degrees counter-clockwise). Regular grids intended for rendering contours cannot be rotated.

A special case of a regular grid is the grid consisting of a single receptor, where the starting point for the grid is given by the lower-left corner, the distance between grid points is zero, and the size of the grid is

one-by-one. These types of regular grids may be used to assess points of interest that are considered sensitive.

In order to improve contour fidelity and resolution, INM implemented the recursive grid concept, where the user defined the extent of a contour grid and tolerance parameters, which were then used by the software to refine the grid point distribution of the contour grid in areas showing variation in noise levels. Instead of using recursive grids, AEDT uses dynamic grids. The dynamic grid concept in AEDT is also used to improve contour fidelity and resolution, but instead of using grid recursion (or subdivision), the user defines a small starting grid, and the grid point distribution is expanded until all of the contours in a user-specified contour range are covered by the grid. There are two primary benefits to the dynamic grid:

1. The user does not need to know the geographic extent of the region of interest. Instead, the user only needs to know the minimum noise level of interest and AEDT will discover the geographic extents needed for the receptor set to close that lowest contour level (and by implication all higher noise level contours). The user may also limit the geographic area by defining a boundary.
2. The resolution of the dynamic grid is variable over the receptor set. AEDT evaluates the geographic variation of the noise level and where the noise level is changing spatially, the system adds additional refinement to the dynamic grid by cutting the resolution of the grid in that region by a factor of two, effectively quadrupling the number of receptors analogous to the INM recursive grid. The benefit is more effective application of computational power on regions that matter most.

The improvement over legacy tool dynamic grid implementations is that the receptor set can now grow dynamically as necessary to close the contour of interest.

Refer to Section 4.7 for additional information on specifying the initial parameters for a dynamic grid and the AEDT process that then evaluates and stores the resulting receptor set.

#### **2.2.1.7 Noise Metric Information**

The noise-level and time-based metrics computed by AEDT are associated with three fundamental Groups: A-weighted, C-weighted, and tone-corrected perceived noise metrics.

A-weighted noise metrics give less weighting to the low and high frequency portions of the spectrum, providing a good approximation of the response of the human ear, and correlates well with an average person's judgment of the relative loudness of a noise event. C-weighted noise metrics are intended to provide a means of simulating human perception of the loudness of sounds above 90 decibels, and is more prominent at low frequencies than A-weighting. Tone-corrected perceived noise metrics are used to estimate perceived noise from broadband sound sources, such as aircraft, which can have significant tonal qualities.

AEDT supports the noise metrics listed in Table 2-5, as well as the capability to create user-defined noise metrics.

Table 2-5 Summary of AEDT Noise Metric Abbreviations and Definitions

Metric Type	AEDT Name	Standard Name	Definition/Full Name
<b>A-Weighted Noise Metrics</b>			
Exposure	SEL	$L_{AE}$	A-Weighted Sound Exposure Level
	DNL	$L_{dn}$	Day Night Average Sound Level
	CNEL	$L_{den}$	Community Noise Equivalent Level
	LAEQ	$L_{AeqT}$	Equivalent Sound Level
	LAEQD	$L_d$	Day-average noise level
	LAEQN	$L_n$	Night-average noise level
Maximum Level	LAMAX	$L_{ASmx}$	A-Weighted Maximum Sound Level
Time-Above	TALA	$TA_{LA}$	Time-Above A-Weighted Level
	TALASC	$TA_{Iasc}$	Time Above A-Weighted Level with Statistical Compression
Time-Audible	TAUD	$T_{Aau}$	Time-Audible
	TAUDSC	$T_{AudSC}$	Time-Audible with Overlapping Events Method (Statistical Compression)
	TAUDP	$T_{AudP}$	Time-Audible Percent
	TAUDPSC	$T_{AudPSC}$	Time-Audible Percent with Overlapping Events Method (Statistical Compression)
<b>C-Weighted Noise Metrics</b>			
Exposure	CEXP	$L_{CE}$	C-Weighted Sound Exposure Level
	CDNL	$L_{cdn}$	C-Weighted Day Night Average Sound Level
Maximum Level	LCMAX	$L_{CSmx}$	C-Weighted Maximum Sound Level
Time-Above	TALC	$TA_{LC}$	Time-Above C-Weighted Level
	TALCSC	$TA_{Icsc}$	Time Above C-Weighted Level with Statistical Compression
<b>Tone-Corrected Perceived Noise Metrics</b>			
Exposure	EPNL	$L_{EPN}$	Effective Perceived Noise Level
	NEF	$L_{NEL}$	Noise Exposure Forecast
	WECPNL	$L_{WECPN}$	Weighted Equivalent Continuous Perceived Noise Level
Maximum Level	PNLTM	$L_{PNTSmx}$	Tone-Corrected Maximum Perceived Noise Level
Time-Above	TAPNL	$TA_{PNL}$	Time-Above Perceived Noise Level
	TAPNLSC	$TA_{pnlsc}$	Time Above P-Weighted Level with Statistical Compression
<b>Number Above Noise Level Metric</b>			
Number Above Noise Level	NANL	NANL	Number Above Noise Level

All of the metrics in Table 2-5 are computed using the following four base noise level metrics:

$L_{AE}$	A-weighted sound exposure level (SEL);
$L_{ASmx}$	A-weighted maximum sound level (LAMAX);
$L_{EPN}$	Effective perceived noise level (EPNL); and
$L_{PNTSmx}$	Tone-corrected maximum perceived noise level (PNLTM).

Each NPD in the AEDT Fleet database has noise level data that correspond to one of these four base metrics. In addition, A-weighted NPDs ( $L_{AE}$  and  $L_{ASmx}$ ) and the corresponding spectral class data are used to approximate the following C-weighted noise metrics to complement the AEDT Fleet database:

$L_{CE}$	C-weighted sound exposure level (CEXP); and
$L_{CSmx}$	C-weighted maximum sound level with slow-scale exponential weighting characteristics (LCMAX).

The C-weighting approximation method is described in Section 4.2.1.2.

The base metrics are then used to compute three types of metrics in AEDT:

1. Exposure-based metrics, including change in exposure;
2. Maximum noise level metrics; and
3. Time-based metrics.

The exposure-based metrics represent the total sound exposure for a given time period, often 24 hours, at a receptor location based upon average annual day conditions at an airport. AEDT base sound exposure metrics are:

$L_{AE}$	A-weighted sound exposure level (SEL);
$L_{CE}$	C-weighted sound exposure level (CEXP); and
$L_{EPN}$	Effective tone-corrected perceived noise level (EPNL).

These base sound exposure metrics are used by AEDT to generate average noise metrics by applying associated time-averaging constants and/or day, evening, and night-time weighting factors. AEDT standard average-level metrics based on SEL are:

$L_{dn}$	Day-night average noise level (DNL);
$L_{den}$	Community noise equivalent level (CNEL);
$L_{Aeq24h}$	24-hour average noise level (LAEQ);
$L_d$	15-hour (0700-2200) day-average noise level (LAEQD); and
$L_n$	9-hour (2200-0700) night-average noise level (LAEQN).

AEDT standard average-level metrics based on CEXP are:

$L_{NEF}$	Noise exposure forecast (NEF); and
$L_{WECPN}$	Weighted equivalent continuous perceived noise level (WECPNL).

The maximum noise level metrics represent the maximum noise level at a receptor location, taking into account a particular set of aircraft operations. AEDT standard maximum noise level metrics are:

$L_{ASmx}$	Maximum A-weighted sound level with slow-scale exponential weighting characteristics (LAMAX);
$L_{CSmx}$	Maximum C-weighted sound level with slow-scale exponential weighting characteristics (LCMAX); and
$L_{PNTSmx}$	Maximum tone-corrected perceived noise level with slow-scale, exponential weighting characteristics (PNLTM).

The time-based metrics represent the time (minutes) that the noise level is above a specified threshold, taking into account aircraft operations for a particular time period (24 hours). In AEDT, time-based metrics are derived from either exposure or maximum noise level metrics, or both. The derivation of the time-above metrics is presented in Section 11.1.3. AEDT standard time-based metrics are:

$T_{ALA}$	Time that the A-weighted noise level is above a user-defined sound level during the time period (TALA);
$T_{ALC}$	Time that the C-weighted noise level is above a user-defined sound level during the time period (TALC); and
$T_{APNL}$	Time that the tone-corrected perceived noise level is above a user-defined noise level during the time period (TAPNL).

A subset of the time-based metrics is time audible. Time audible (or audibility) is computed based on a comparison of aircraft noise against ambient noise to determine the time duration (or percentage of time duration) that the noise may be audible to a human observer. For these calculations, the observer is assumed to have normal hearing and to be actively listening for aircraft noise. Time audible also takes into account aircraft operations for a particular time period (e.g., 24 hours). The process is based on detectability theory and is supplemented with research that has assessed human auditory detectability in different environments. In order to represent these different environments, the time audible metrics require highly detailed inputs, including FAA AEE-approved ambient noise files. More details on ambient noise file requirements can be obtained by contacting FAA AEE (see Sections 2.2.3.6 and 2.2.3.7 for more information).

Section 11.1.5 provides additional specifics on the theory and background of the time audible computation. A detailed discussion of audibility calculations is also presented in the “Assessment of Tools for Modeling Aircraft Noise in the National Parks”<sup>31</sup>. AEDT standard time audible metrics are:

$T_{Aud}$	Time that aircraft are audible given study specific ambient noise (TAUD); and
$T_{AudSC}$	Time that aircraft are audible given study specific ambient noise with simultaneously occurring aircraft events (overlapping events) are accounted for with the statistical compression method (TAUDSC). Refer to Section 4.6.5.4.1 for description on the statistical compression method.

Time audible metrics may also be expressed as a percentage of time that aircraft are audible given study specific ambient noise during the analysis time period.

In addition to the AEDT standard noise metrics, user-defined metrics are available. User-defined metrics must be derived from the base noise metrics in AEDT. The methods for calculating these types of metrics in AEDT are presented in Section 4.6. Number Above Noise Level can be computed from the base noise metrics: SEL, LAMAX, LCMAX and CEXP. The method for calculating Number Above Noise Level is presented in Section 4.6.

### 2.2.2 Summary of Input Data for Emissions Inventory Computation

This section summarizes the input data necessary to compute an emissions inventory. AEDT provides default values for critical emissions parameters (e.g., emissions index, fuel sulfur content, etc.), but they can be overridden by the user. Default data values are either average values, typical values, or conservative values – values chosen to avoid the underreporting of emissions. Overriding default data is justified if the user possesses data that is more accurate than supplied default data.

An emissions inventory is an exhaustive list of the masses of various pollutants emitted within a given geographic region and time period (typically, one year). Emission inventories may attempt to capture all emissions across all source types and sectors or may be focused on specific sectors. For this document, the emissions inventories refer to aircraft and airport related emissions; including emissions from terminal-area and runway-to-runway operations. Emissions inventories are typically itemized by individual emissions sources and source activities and include the following pollutants:

- Carbon Monoxide (CO),
- Total Hydrocarbons (THC),
- Non-Methane Hydrocarbons (NMHC),
- Volatile Organic Compounds (VOC),
- Total Organic Gases (TOG),
- Nitrogen Oxides (NO<sub>x</sub>),
- Sulfur Oxides (SO<sub>x</sub>),
- Coarse Particulate Matter with aerodynamic diameter of  $\leq 10 \mu\text{m}$  (PM<sub>10</sub>),
- Fine Particulate Matter with aerodynamic diameter of  $\leq 2.5 \mu\text{m}$  (PM<sub>2.5</sub>),
- Non-Volatile Particulate Matter (nvPM),
- Volatile Sulfate Particulate Matter (PMSO),
- Volatile Organic Particulate Matter (PMFO),
- Carbon Dioxide (CO<sub>2</sub>),
- Water (H<sub>2</sub>O), and
- Speciated Organic Gases (SOG), such as
  - Methane (CH<sub>4</sub>),
  - Formaldehyde,
  - Toluene,
  - Xylenes, and
  - Other potentially hazardous air pollutants of concern.

Fuel consumption is closely associated with emissions inventories; and therefore, is reported along with pollutants.

To begin an emissions inventory, the user must first know the spatial and temporal scope of the emissions to be included. For example, the spatial scope could be the airport fence line for ground-based sources and the terminal control area for airborne aircraft. This is not to be confused with the geographic scope of receptor locations which typically extends well beyond the emissions source locations and into public, residential and other commercial areas in the vicinity. Moreover, the user must specify a vertical limit called the atmospheric “mixing height” which bounds the spatial scope of emissions sources vertically. AEDT uses 3,000 ft AFE unless the user modifies this default value.

The temporal scope refers to a specific period of time covered by the inventory. This could be a historical year (e.g., 2000), a future year, or another interval of time (e.g., a single month). Just as spatial scope refers to a specific geographic region, temporal scope refers to a specific period of time on a calendar, as opposed to some generic day, week, or month.

Given a spatial and temporal scope, the user must know which pollutant emitting activities are to be modeled for the emissions sources. AEDT emissions inventories are limited to the following types of emissions sources:

- Aircraft Operations
- Runup Operations
- Auxiliary Power Units (APU)
- Ground Support Equipment (GSE)
- Stationary Sources, such as
  - Boilers and Space Heater;
  - Emergency Generator;
  - Incinerator;
  - Aircraft Engine Testing
  - Fuel Tank;
  - Surface Coating/Painting;
  - Deicing;
  - Solvent Degreaser;
  - Sand/Salt Pile;
  - Training Fire; and
  - “Other” stationary sources.
- Motor Vehicle Emission Simulator (MOVES) Emissions Inventory File (refer to Section 2.2.2.15) that contains
  - Roadway;
  - Parking; or
  - Construction.

Each following subsection describes the necessary input data for each of the emissions source types.



### 2.2.2.1 Aircraft Operations

Emissions from aircraft operations only consider pollutants emitted from an aircraft's main engine and exclude emissions from APUs, which are typically found installed onboard aircraft. APUs are modeled as separate types of emissions sources.

The following input data are required:

- Airport layout (for departures and arrivals, required for delay and sequencing modeling)
  - Runway locations;
  - Gate locations;
  - Taxiway locations; and
  - Taxipath definitions.
  
- Aircraft operation schedule
  - Date and time;
  - Operation type (e.g., departure, arrival, touch and go, etc.);
  - Airframe model;
  - Engine model;
  - Flight profile;
  - Runway;
  - Flight track; and
  - Gate (for departures and arrivals).
  
- Meteorological conditions
  - Mean sea level pressure;
  - Temperature;
  - Relative humidity; and
  - Wind (speed and direction).

The meteorological parameter values should be applicable to the geography where the operation occurs and should reflect the prevailing local ambient conditions when the operation occurs.

### 2.2.2.2 Runup Operations

Emissions from runup operations consider pollutants emitted from an aircraft's main engine. The following input data are required:

- Airport layout
  
- Runup operation
  - Date and time;
  - Location of runup (latitude, longitude, and heading);
  - Airframe model;
  - Engine model;
  - Number of engines used;

- Thrust setting per engine; and
- Duration of the time average thrust setting is in effect.
- Meteorological conditions
  - Mean sea level pressure;
  - Temperature;
  - Relative humidity; and
  - Wind (speed and direction).

The meteorological parameter values should be applicable to the geography where the operation occurs and should reflect the prevailing local ambient conditions when the operation occurs.

### 2.2.2.3 Auxiliary Power Unit (APU)

APUs are typically installed on sufficiently large commercial aircraft. An APU operation therefore only occurs in conjunction with the operation of the aircraft on which the APU is installed.

Default emissions factor data are provided for system APUs. For user-defined APUs, the user can modify the emission factors. Table 2-6 summarizes the input data for APUs. APU particulate matter emissions are assumed to be entirely in the fine mode fraction; thus, reported PM<sub>2.5</sub> and PM<sub>10</sub> emissions will be equal.

Table 2-6 Input Data for APU

Parameter Name	Units
Duration (operating time)	Minutes
CO emission factor	Kilograms per hour
THC emission factor	Kilograms per hour
NO <sub>x</sub> emission factor	Kilograms per hour
SO <sub>x</sub> emission factor	Kilograms per hour
PM <sub>10</sub> emission factor	Kilograms per hour

### 2.2.2.4 Ground Support Equipment (GSE)

Ground Support Equipment (GSE) subcategories are determined by GSE type (e.g., air conditioner, baggage tractor, etc.) and by fuel type.

GSE emissions can be modeled in two different ways:

- “Aircraft-assigned GSE” which occurs in conjunction with the aircraft operation to which a GSE is assigned; or
- Non-aircraft operation (“GSE population”) in which total annual GSE operation time is accounted for, independent of aircraft operations.

Table 2-7 summarizes the input data for aircraft-assigned GSE. Default emission factor data are provided for system GSE. For user-defined GSE, the user can modify emission factors. Note that deterioration is not applied to user-defined GSE, and therefore manufacture year and age are not required.

Table 2-7 Input Data for Aircraft-Assigned GSE

Parameter Name	Units
Duration (operating time)	Minutes
Horsepower (power rating)	Horsepower
Load factor	Percent
Manufacture Year	N/A
CO emission factor	Grams per horsepower-hour
THC emission factor	Grams per horsepower-hour
NO <sub>x</sub> emission factor	Grams per horsepower-hour
PM <sub>10</sub> emission factor	Grams per horsepower-hour
PM <sub>2.5</sub> emission factor	Grams per horsepower-hour
CO <sub>2</sub> emission factor	Grams per horsepower-hour
CH <sub>4</sub> emission factor	Grams per horsepower-hour

Table 2-8 summarizes the input data for GSE population. For a GSE population, the user provides the annual operating time (in hours) and the number of GSE units (population size). Default values are provided for horsepower and load factor. For user-defined GSE, the user can modify the emission factors. Note that deterioration is not applied to user-created GSE, and therefore manufacture year and age are not required.

Table 2-8 Input Data for GSE Population

Parameter Name	Units
Operation count (operating time)	Hours per year
Operational profiles	Dimensionless
Number of units (population size)	Pieces of GSE
Horsepower (power rating)	Horsepower
Load factor	Percent
Manufacture Year	N/A
CO emission factor	Grams per horsepower-hour
THC emission factor	Grams per horsepower-hour
NO <sub>x</sub> emission factor	Grams per horsepower-hour
PM <sub>10</sub> emission factor	Grams per horsepower-hour
PM <sub>2.5</sub> emission factor	Grams per horsepower-hour
CO <sub>2</sub> emission factor	Grams per horsepower-hour
CH <sub>4</sub> emission factor	Grams per horsepower-hour

### 2.2.2.5 Boilers and Space Heaters

Boilers and space heaters are stationary sources with a large variety of subcategories that are determined by a combination of fuel type, technology, capacity, and/or application.

Fuel types include:

- Coal (such as Anthracite, Bituminous, Sub-bituminous, and Culm);
- Fuel oil (such as Distillate, Number 2, Number 4, Number 5, and Number 6);
- Natural gas; and
- Liquefied petroleum gas (Butane and Propane).

Technology refers to boiler and space heater terms such as:

- Control Technology;
- Pre- or Post-New Source Performance Standards (NSPS);
- Dry bottom or wet bottom;
- Wall-fired, cell burner fired, or tangentially-fired;
- Cyclone furnace;
- Spreader stoker; and
- Reinjection.

Boilers are either uncontrolled (no emissions control technology) or controlled (emissions control targeting a specific pollutant). Some boiler types are also distinguished by capacity (e.g., 10-100 Million BTU or >100 Million BTU) and whether they are used in a utility, industrial, or commercial application.

The user must determine which combination of these types most appropriately represent the boiler or space heater being modeled. Operation unit is different depending on the fuel type used by the boiler or heater. The following table summarizes the input data for boilers and space heaters.

Table 2-9 Input Data for Boilers and Space Heaters

Parameter Name	Units
Operation count (number of units consumed)	Units per year; units by fuel type:  Coal, including anthracite & culm: metric tons Fuel oil: kiloliters LPG: 1000 cubic meters NG: kiloliters
Operational profiles	Dimensionless
CO emission index	Kilograms per unit
THC, TNMOC, TOC, and VOC emission indices	Kilograms per unit
NOx emission index	Kilograms per unit
SOx emission index sulfur term	Natural gas: emissions index in kilograms per kiloliter; Other fuel types: fuel sulfur multiplier in kilograms per unit/percent fuel sulfur content
PM <sub>10</sub> emission index	Kilograms per unit. For some subcategories, the PM emission index is calculated from fuel sulfur content and/or fuel ash content.
CO <sub>2</sub> emission index	Kilograms per unit
CH <sub>4</sub> emission index	Kilograms per unit

Parameter Name	Units
PM <sub>10</sub> (ash) constant	Kilograms per unit-percent fuel ash content
PM <sub>10</sub> emission index sulfur term	Kilograms per unit-percent fuel sulfur content
Fuel sulfur content	Percent
Fuel ash content	Percent
CO pollution control factor	Percent
THC, TNMOC, TOC, and VOC pollution control factors	Percent
NO <sub>x</sub> pollution control factor	Percent
SO <sub>x</sub> pollution control factor	Percent
PM <sub>10</sub> pollution control factor	Percent
CO <sub>2</sub> pollution control factor	Percent
CH <sub>4</sub> pollution control factor	Percent
PM <sub>2.5</sub> to PM <sub>10</sub> ratio	Dimensionless

### 2.2.2.6 Emergency Generator

Emergency generators are modeled via two distinct methodologies: The Environmental Protection Agency (EPA) methodology and the United States Air Force (USAF) methodology. Each methodology has different input data requirements.

Emergency generator subcategory is determined by the combination of methodology and fuel type. The fuel types for emergency generators include:

- Gasoline;
- Diesel;
- Distillate fuel oil;
- Kerosene/naphtha (jet fuel);
- Natural gas;
- Liquefied petroleum gas; and
- Residual and crude fuel oil.

Table 2-10 and Table 2-10 describe the input data for the EPA and USAF methodologies, respectively.

Table 2-10 Input Data for Emergency Generator (EPA Methodology)

Parameter Name	Units
Operation count (time operated)	Hours per year
Operational profiles	Dimensionless
Power rating	Horsepower
CO emission factor	Grams per horsepower-hour
TOC emission factor	Grams per horsepower-hour
NO <sub>x</sub> emission factor	Grams per horsepower-hour
SO <sub>x</sub> emission factor	Grams per horsepower-hour
PM <sub>10</sub> emission factor	Grams per horsepower-hour
CO <sub>2</sub> emission factor	Grams per horsepower-hour
CH <sub>4</sub> emission factor	Grams per horsepower-hour

Parameter Name	Units
CO pollution control factor	Percent
TOC pollution control factor	Percent
NO <sub>x</sub> pollution control factor	Percent
SO <sub>x</sub> pollution control factor	Percent
PM <sub>10</sub> pollution control factor	Percent
CO <sub>2</sub> pollution control factor	Percent
CH <sub>4</sub> pollution control factor	Percent
PM <sub>2.5</sub> to PM <sub>10</sub> ratio	Dimensionless

Table 2-11 Input Data for Emergency Generators (USAF Methodology)

Parameter Name	Units
Operation count (volume of fuel used)	Kiloliters per year
Operational profiles	Dimensionless
CO pollution control factor	Percent
TOC pollution control factor	Percent
NO <sub>x</sub> pollution control factor	Percent
SO <sub>x</sub> pollution control factor	Percent
PM <sub>10</sub> pollution control factor	Percent
CO <sub>2</sub> pollution control factor	Percent
CH <sub>4</sub> pollution control factor	Percent
CO emission index	Kilograms per kiloliter
TOC emission index	Kilograms per kiloliter
NO <sub>x</sub> emission index	Kilograms per kiloliter
SO <sub>x</sub> emission index	Kilograms per kiloliter-percent fuel sulfur content
PM <sub>10</sub> emission index	Kilograms per kiloliter
CO <sub>2</sub> emission index	Kilograms per kiloliter
CH <sub>4</sub> emission index	Kilograms per kiloliter
Fuel sulfur content	Percent
PM <sub>2.5</sub> to PM <sub>10</sub> ratio	Dimensionless

### 2.2.2.7 Incinerator

For incinerators, the user must determine which type (i.e., Controller Air or Rotary Kiln) best represents the incinerator being modeled. Table 2-12 summarizes the input data required for incinerators.

Table 2-12 Input Data for Incinerator

Parameter Name	Units
Operation count (mass consumed)	Metric tons per year
Operational profiles	Dimensionless
CO emission index	Kilograms per metric ton
TOC emission index	Kilograms per metric ton
NO <sub>x</sub> emission index	Kilograms per metric ton
SO <sub>x</sub> emission index	Kilograms per metric ton
PM <sub>10</sub> emission index	Kilograms per metric ton
CO <sub>2</sub> emission index	Kilograms per metric ton
CH <sub>4</sub> emission index	Kilograms per metric ton
CO pollution control factor	Percent
VOC pollution control factor	Percent
NO <sub>x</sub> pollution control factor	Percent
SO <sub>x</sub> pollution control factor	Percent
PM <sub>10</sub> pollution control factor	Percent
CO <sub>2</sub> pollution control factor	Percent
CH <sub>4</sub> pollution control factor	Percent
PM <sub>2.5</sub> to PM <sub>10</sub> ratio	Dimensionless

### 2.2.2.8 Aircraft Engine Testing

Table 2-13 summarizes the input data required for aircraft engine testing emissions sources.

Table 2-13 Input Data for Aircraft Engine Testing

Parameter Name	Units
Operation count (number of test cycles)	Test cycles per year
Operational profiles	Dimensionless
Aircraft engine model	N/A
Time at 7% power	Minutes per test cycle
Time at 30% power	Minutes per test cycle
Time at 85% power	Minutes per test cycle
Time at 100% power	Minutes per test cycle

### 2.2.2.9 Fuel Tank

Table 2-14 summarizes the input data required for fuel tank emissions sources. Fuel tank subcategories are determined by fuel type and tank type.

AEDT can model six different tank types:

- Vertical fixed roof, cone;
- Vertical fixed roof, dome;

- Horizontal fixed roof;
- Floating Roof, Internal;
- Floating Roof, External; and
- Floating Roof, Domed External.

Fuel tanks in AEDT may store the following fuels:

- Jet naphtha (JP-4);
- Jet kerosene;
- Gasoline;
- Distillate fuel oil No. 2; and
- Residual fuel oil No. 6.

Table 2-14 Input Data for Fuel Tank

Parameter Name	Units
Operation count (fuel throughput)	Kiloliters per year
Operational profiles	Dimensionless
Tank height (length, if horizontal)	Meters
Tank diameter	Meters
Average liquid height (vertical fixed roof only)	Meters
Maximum liquid height (vertical fixed roof only)	Meters
Annual sum of liquid level increases (vertical fixed roof tanks only)	Feet per year
Roof slope (vertical fixed roof-cone only)	Feet per feet (dimensionless)
Dome radius (vertical fixed roof-dome only)	Meters
Reid vapor pressure	Pounds per square inch
Mean wind speed	Meters per second

### 2.2.2.10 Surface Coating/Painting

Table 2-15 summarizes the input data required for surface coating/painting emissions sources. The surface coating/painting subcategory is determined by the volatile solution.

Table 2-15 Input Data for Surface Coating/Painting

Parameter Name	Units
Operation count (volume used)	Kiloliters per year
Operational profiles	Dimensionless
VOC emission index	Kilograms per kiloliter
Pollution control factor	Percent



**2.2.2.11 Deicing Area**

Table 2-16 summarizes the input data required for deicing area emissions sources. Deicing area subcategories are determined by the deicer chemical used (i.e., ethylene glycol or propylene glycol) and the application (i.e., runway/taxiway surface deicing or aircraft deicing).

Table 2-16 Input Data for Deicing Area

Parameter Name	Units
Operation count (volume used)	Kiloliters per year
Operational profiles	Dimensionless
VOC emission index	Kilograms per kiloliter
Deicing chemical density	Grams per liter
Concentration by mass	Percent

**2.2.2.12 Solvent Degreaser**

Table 2-17 summarizes the input data required for solvent degreaser emissions sources. The solvent degreaser subcategory is determined by the chemical used.

Table 2-17 Input Data for Solvent Degreaser

Parameter Name	Units
Operation count (volume used)	Kiloliters per year
Operational profiles	Dimensionless
Solution density	Grams per liter
Percent of solvent disposed	Percent
Pollution control factor	Percent

**2.2.2.13 Sand/Salt Pile**

Table 2-18 summarizes the input data required for sand/salt piles.

Table 2-18 Input Data for Sand/Salt Pile

Parameter Name	Units
Operation count (mass throughput)	Metric tons per year
Operational profiles	Dimensionless
Eroded surface area	Square meters
Mass disturbed per disturbance	Metric tons
Moisture content	Percent
Mean wind speed (at 10 meter height)	Meters per second
Fastest mile of wind (at 10 meter height)	Meters per second
Friction threshold velocity	Meters per second
Surface roughness	Centimeters

**2.2.2.14 Training Fire**

Table 2-19 summarizes the input data required for training fires. The training fire subcategory is determined by fuel type.

Table 2-19 Input Data for Training Fire

Parameter Name	Units
Operation count (volume of fuel used)	Gallons per year
Operational profiles	Dimensionless
CO emission index	Kilograms per gallon
VOC emission index	Kilograms per gallon
NO <sub>x</sub> emission index	Kilograms per gallon
SO <sub>x</sub> emission index	Kilograms per gallon
PM <sub>10</sub> emission index	Kilograms per gallon
PM <sub>2.5</sub> emission index	Kilograms per gallon
CO <sub>2</sub> emission index	Kilograms per gallon
CH <sub>4</sub> emission index	Kilograms per gallon

### 2.2.2.15 “Other” Stationary Sources

Table 2-20 summarizes the input data required for “Other” stationary sources.

Table 2-20 Input Data for “Other” Stationary Sources

Parameter Name	Units
Operation count (number of units)	Units per year
Operational profiles	Dimensionless
Operation unit	Metric Tons, Kiloliters, Thousands of Cubic Meters, Hours, Test Cycles, Gallons, or Minutes of operation
CO emission index	Kilograms per unit
THC emission index	Kilograms per unit
NO <sub>x</sub> emission index	Kilograms per unit
SO <sub>x</sub> emission index	Kilograms per unit
PM <sub>10</sub> emission index	Kilograms per unit
PM <sub>2.5</sub> emission index	Kilograms per unit
CO <sub>2</sub> emission index	Kilograms per unit
CH <sub>4</sub> emission index	Kilograms per unit
CO pollution control factor	Percent
THC pollution control factor	Percent
NO <sub>x</sub> pollution control factor	Percent
SO <sub>x</sub> pollution control factor	Percent
PM <sub>10</sub> pollution control factor	Percent
CO <sub>2</sub> pollution control factor	Percent
CH <sub>4</sub> pollution control factor	Percent

### 2.2.2.16 MOVES Emissions Inventory File

Emissions inventory results from roadway, parking facility, and/or construction operations can be calculated externally with the EPA MOVES software and integrated into the AEDT emissions report. AEDT can import annualized MOVES results for roadway, parking facilities, and construction zone

categories – either at the category-level or at the link-level. Please refer to the “AEDT Supplemental Manual: Using MOVES with AEDT” on the AEDT Support website for the MOVES file format that can be imported into AEDT.

### 2.2.3 External Data

#### 2.2.3.1 Weather Data for Aircraft Performance Modeling

This section describes the weather data available for use in aircraft performance modeling in AEDT. AEDT can use high fidelity weather, airport annual average weather, or ISA weather for performance modeling used for noise and emissions modeling. Section 6.9 describes the use of weather for Emissions Dispersion Modeling.

The weather data formats and sources supported for Aircraft Performance Modeling in AEDT are described in the Table 2-21. There are additional formats and sources supported for Emissions Dispersion Modeling which are described in the next section.

High fidelity weather data sources must be pre-processed to convert the raw data into a format that AEDT can use. For RAP, GEOS, NCAR weather data types, use the WeatherDataLoder.exe tool. For MERRA-2 and WRF, use the NC4WXEditorWPF.exe. Please refer to “Using Weather Data in AEDT” on the AEDT Support website, Downloads page for details on these tools.

Table 2-21 Weather Data Formats Supported

File Format	AEDT Use	Description Source
Rapid Refresh (RAP20/RAP13) and Rapid Update Cycle (RUC20/RUC13)	Aircraft Performance Modeling	Earth System Research Laboratory (ESRL) Rapid Update Cycle (RUC) <a href="https://ruc.noaa.gov/ruc/">https://ruc.noaa.gov/ruc/</a>
NCEP/NCAR (NCAR)	Aircraft Performance Modeling	National Centers for Environmental Prediction (NCEP) <a href="https://www.weather.gov/ncep/">https://www.weather.gov/ncep/</a>
GEOS	Aircraft Performance Modeling	Goddard Earth Observing System Model (GEOS-5) <a href="https://geos5.org/">https://geos5.org/</a>
Modern-Era Retrospective Analysis for Research and Applications, version 2 (MERRA-2)	Aircraft Performance Modeling	NASA Earthdata website <a href="https://disc.gsfc.nasa.gov/uui/datasets?keywords=%22MERRA-2%22">https://disc.gsfc.nasa.gov/uui/datasets?keywords=%22MERRA-2%22</a>
Weather Research and Forecasting (WRF)- Advanced Research WRF (ARW)	Aircraft Performance Modeling	<a href="https://www.mmm.ucar.edu/weather-research-and-forecasting-model">https://www.mmm.ucar.edu/weather-research-and-forecasting-model</a>
National Centers for Environmental Information (NCEI) Automated Surface	Emissions Dispersion (and associated)	National Centers for Environmental Information (NCEI) weather station data

File Format	AEDT Use	Description Source
Observing System (ASOS), Integrated Surface Hourly Database (ISHD), Integrated Global Radiosonde Archive (IGRA), Forecast Systems Laboratory (FSL)	Aircraft Performance /Emissions Modeling)	collections of surface weather and upper atmosphere soundings.  For additional details, refer to Table 6-4 Accepted Weather Data Formats for Emissions Dispersion Modeling
Annual Average Weather	Aircraft Performance and Acoustics Modeling	AEDT uses the airport annual average weather from the AEDT Airport database from the NOAA Global Summary of the Day (GSOD). Users can select the 10-year average weather data or a single year average weather.  <a href="https://www.ncei.noaa.gov/access/metadata/landing-page/bin/iso?id=gov.noaa.ncdc:C00516">https://www.ncei.noaa.gov/access/metadata/landing- page/bin/iso?id=gov.noaa.ncdc:C00516</a>
International Standard Atmosphere (ISA)	Aircraft Performance Modeling	Suitable for lapsing a vertical weather profile from mean sea level (MSL) with fixed temperature, pressure, and relative humidity for the globe.  <a href="https://en.wikipedia.org/wiki/International_Standard_Atmosphere">https://en.wikipedia.org/wiki/Internation al_Standard_Atmosphere</a>

#### 2.2.3.1.1 Airport Weather – Ten-Year Average and Single Year Annual Average Weather

The AEDT Airport database stores average airport weather data for the most recent 10+ years as single year averages along with a rolling 10-year average; if the data are available for an airport<sup>viii</sup>. For example, the weather station ID 724940 (SAN FRANCISCO INTL ARPT) in the Airport database has average weather data for the individual years 2010 through 2022 and for the 10-year average weather data from 2013-2022. The source for the airport weather data included in the AEDT Airport database is the most recent data from the Integrated Surface Database ([ISD](#)) from the National Oceanic and Atmospheric Administration (NOAA) at the time of the AEDT release.

When the user selects airport average annual weather for aircraft performance modeling, users can select the 10-year average weather or a single year average weather. Users also have the option of creating user-defined airport weather data which consists of temperature, pressure, sea level pressure, relative humidity, dew point, and wind speed.

<sup>viii</sup> The 10-year average data is an average of available data within a 10-year period. Data may not be available for a full 10 years for every airport.

If weather data for the selected airport weather year (either an individual year or 10-year average, selected in the Set Processing Options screen of the Define Metric Result wizard) is missing for aircraft performance modeling, AEDT will substitute the missing data according to the following hierarchy:

1. Analysis weather year (i.e., operation/event time)
2. 10-year average weather data
3. ISA weather

### 2.2.3.1.2 Airport Weather – Temperature, Dew Point, and Relative Humidity

This section describes the August-Roche-Magnus approximation which used to calculate a combination of temperature, dew point, and relative humidity values in the AEDT Definitions tab, Airport Weather dialog. AEDT uses the August-Roche-Magnus approximation to calculate the third value in the combination when temperature and a second value is provided (i.e., relative humidity or dew point).

AEDT calculates relative humidity, RH (%), for a given temperature, T (°C) and dew point, T<sub>d</sub> (°C), by the equation:

$$RH = 100 \frac{\exp\left(\frac{aT_d}{b + T_d}\right)}{\exp\left(\frac{aT}{b + T}\right)} \quad \text{Eq. 2-1}$$

where

$$\begin{array}{ll} a & 17.625; \text{ and} \\ b & 243.04. \end{array}$$

AEDT calculates dew point, T<sub>d</sub> (°C), for a given temperature, T (°C) and relative humidity, RH (%), by the equation:

$$T_d = \frac{b \left[ \ln\left(\frac{RH}{100}\right) + \frac{aT}{b + T} \right]}{a - \ln\left(\frac{RH}{100}\right) - \frac{aT}{b + T}} \quad \text{Eq. 2-2}$$

where

$$\begin{array}{ll} a & 17.625; \text{ and} \\ b & 243.04. \end{array}$$

The August-Roche-Magnus approximation is considered valid for:

$$0^\circ\text{C} < T < 60^\circ\text{C}$$

$$1\% < RH < 100\%$$

$$0^\circ\text{C} < T_d < 50^\circ\text{C}$$

### 2.2.3.1.3 Weather Data Interpolation

This section describes the details of the interpolator currently implemented in the AEDT Weather Module. The AEDT Weather Module accepts requests to evaluate four weather variables (temperature, barometric pressure, humidity, and wind vector) at 4D locations (latitude, longitude, altitude, and time) specified as input to the module. As listed in Table 2-21, AEDT supports a variety of weather data sources.

The linear interpolation between two known points  $(x_0, y_0)$  and  $(x_1, y_1)$ , the value  $(x, y)$  along the straight line is given from the slope to be the same:  $(y - y_0)/(x - x_0) = (y_1 - y_0)/(x_1 - x_0)$ . This equation is valid whether  $x$  is between  $x_0$  and  $x_1$  or not. Thus it can be used for “extrapolation” for  $x$  being outside of the region. When dealing with more than one spatial dimension, the extension is very simple and they are called bilinear interpolation, trilinear interpolation, quad liner interpolation where the equation becomes no longer linear in the spatial coordinate. However, this extension to more than one dimension has the special property that the order of calculation does not matter (e.g., for bilinear interpolation, you can start the interpolation along  $x$  first and then  $y$  second or  $y$  first and then  $x$  second). If polynomial or spline interpolation is used, then this property no longer holds. AEDT uses the quad-linear ( $x$ - $y$  grid  $x$  height  $x$  time) interpolation or extrapolation. It is important to note that AEDT is using the simple linear form from one value to the next without any constraints. In the weather data, the weather variables have physical constraints. For example, the relative humidity is between 0 and 100%; and the temperature in Kelvin units should never become negative. These constraints could be violated when the data is extrapolated too much.

For RUC/RAP, GEOS, and NCAR weather data types, the Weather Module processes available sources in a prioritized cascade from highest fidelity to lower fidelity to find the first (highest) weather source that covers the desired location. In addition, a control (i.e., weather fidelity) is available that limits the starting (highest) fidelity source regardless of the full set of sources supplied in the study. This control/limit mechanism is useful for testing and initial processing to evaluate computational performance and environmental results with various controlled sources.

WRF and MERRA-2 high fidelity weather data are handled differently compared to RUC/RAP, GEOS, and NCAR. The cascade of weather data sources method is not applied to WRF and MERRA-2. This means that if there are no WRF/MERRA-2 data available at the requested location and time, the affected aircraft operation will fail, and an error will be logged. AEDT does not substitute missing WRF/MERRA-2 data with average annual airport weather.

Except a few special exceptions, the Weather Module linearly interpolates the provided weather data sources at the input location. An instance of the Weather Module is created by the system when a metric result is run. This weather module instance is initialized with the available weather sources (Table 2-21) specified (and provided) by the analyst in the study configuration. For RUC/RAP, GEOS, and NCAR weather data types, the weather data is prioritized in order of highest fidelity first.

The Weather Module instance is then available to the system to accept weather data retrieval requests on demand and evaluates those request at the given location (position and time). The following logical sequence is used to evaluate the weather variables at the desired location during the Weather Data Retrieval process (Section 2.2.3.1.3).

The procedure of obtaining a weather at particular latitude and longitude with an altitude at a particular time is done in the following way:

1. The bounding times are calculated for the weather data source that bound (just before and just after) the desired time, since the weather data has only limited hours data per day.
2. The 2D bounding indices in the projection x/y or lat/lon are calculated for the weather data source that bound the desired x/y or lat/lon coordinates.
3. Weather variables for the full “column” of x/y/time indices are retrieved from the weather source. That is, the weather variables from all layers in the vertical dimension at four 2D grid bounding points at bounding time are retrieved. The full set of vertical layers is necessary to resolve the geographic altitude. Usually, layers are a pressure layer where all grid points on this layer has the same pressure level (an exception is WRF where grid points on the layer do not have the same pressure). Note that the grid points on this layer will have different geopotential heights.
4. For weather data sources that reside in pressure altitude coordinates, the geopotential height is used to calculate a bounding geographic altitude for the layer. The two layers between the desired geographic height are then applied to select weather variables at the 16 data points (two bounding coordinates for each of latitude, longitude, geographic altitude, and time) to be used in the linear interpolation.
  - A slight complication may arise in this step. Altitude-bounded selected layers on four grid points may not belong to the same upper and lower layer at four points, since the geopotential heights of the grid points are usually all different. When the different layers at each point are mixed for interpolation, it may introduce a discontinuity compared to the weather from the previous flight point. In order to avoid this issue, a voting method based on how many grid points have the same upper and lower layers is used. That is, if three grid points use the same layers, then the fourth grid point is made to also use the same layers to obtain the “interpolated” weather data. If there is a tie (i.e., two grid points use the same upper and lower layers), then the lower layers are used; however, this is a very rare case.
5. All weather variables at the sixteen data point locations are then used to linearly interpolate the weather data variables at the desired lat/lon/alt/time location.
  - A slight complication may occur because the height requested could be lower than the grid points of the lowest layer. A voting method is applied to handle this issue. If the geopotential heights of three grid points of the lowest layer are below the requested height or no surface data is available, then the lowest layer and the layer above are used to do mixed “interpolate/extrapolate” operation.
6. If the separate surface layer is available (MERRA-2 or WRF), then the “interpolation” of the lowest layer and the surface layer grids are used. Unfortunately, MERRA-2 3d and 2d weather have different resolution (every three hours for 3d and every hour for 2d). In this case, the interpolated hourly lowest layer weather data for 3d combined with the 2d hourly surface weather data are produced in order to do the “interpolation”.
  - Again a slight complication can occur if the height requested is below the geopotential height of the surface grid points. A voting method is applied again. If three “surface” grid points are

below the requested height, then do the “interpolation” of the lowest layer and the surface layer. If not (i.e., more than two surface grid points are below the requested height), then pick the nearest neighbor grid point for the weather value.

#### 2.2.3.1.4 Weather Cache Processing

##### *Weather Cache Processing for RUC/RAP, GEOS, and NCAR*

The RUC/RAP, GEOS, and NCAR weather data types are gridded sources stored in externally defined formats. For memory limitation and computational efficiency, data from these weather sources that lies within the high-fidelity weather boundary (see Section 2.2.3.3) are loaded into the weather cache before AEDT metric results are run to generate results.

There are two main areas of weather cache processing for RUC/RAP, GEOS, and NCAR: the preloading of the weather cache (Weather Cache Loader); and the retrieval of weather from the cache (Weather Cache Populator).

The Weather Cache Loader performs the following steps:

1. A bounding polygon (high-fidelity weather boundary) is defined in the Weather Module
2. The data grid points from the weather source for all available time that fall within the bounding polygon are loaded into memory. Locations submitted in requests to the Weather Module can then be quickly evaluated.

The Weather Cache Populator performs the following steps:

1. The list of existing dates in the weather source are used to initialize the list of dates currently in the cache
2. The type of each weather source is recorded and stored in the prioritized cache list
3. For each weather data type, the following steps are performed:
  - a. A weather cache list for that type is initialized.
  - b. The list of applicable files is gathered from the directories.
  - c. For each file, a weather reader is instantiated based on the weather data type.
  - d. For each time slice the start time is calculated to be used as a time index in the cache.
  - e. The set of requested dates for the cache is updated to include any new dates.
  - f. All weather data located within the bounding polygon for the cached dates.

##### *Weather Cache Processing for MERRA-2 and WRF*

For MERRA-2 and WRF, the NetCDF4 functionality of cache mechanism is used. The cache parameters are set in the AEDT application configuration file (AEDT.exe.config) in the last part of <appSettings> section. Users can experiment with changing these values for performance improvement.

```
<!-- MERRA2 cache configuration -->
<add key="cacheSizeInMB" value="350"/>
<add key="cacheNelemInMB" value="1"/>
<add key="cachePreemption" value="0.75"/>
```

For MERRA-2 and WRF, a high-fidelity weather boundary is not needed.



---

AEDT can process WRF data in Lambert Conformal Conic (LCC) Projection. While MERRA-2 covers the entire earth, the NC4WXEditorWPF.exe tool can be used to limit the region. If an aircraft operation goes outside of the weather boundary (outside of the LCC boundary for WRF or user selected region in MERRA-2), the null is returned for weather value and the affected flight will fail.

#### 2.2.3.1.5 Weather Data Retrieval for RUC/RAP, GEOS, and NCAR

For the RUC/RAP, GEOS, and NCAR weather data types, the retrieval of weather data follows a logical cascade through the available weather sources (default, system, and user) in order of fidelity, highest to lowest. Note that the user can override available weather by setting a weather fidelity limit flag (e.g., if a high fidelity weather source such as NCAR has been provided but the user wishes to limit the weather fidelity). The following steps are performed to retrieve weather data in this method.

1. If the location is null or the weather fidelity limit is set to ISA-only, ISA weather is returned.
2. An attempt is made to retrieve weather from the list of supplied data sources.
  - a. First is a high fidelity weather call to the Weather Module is made which performs the following steps:
    - i. The weather cache manager is used to retrieve the weather cache.
    - ii. The list of available weather data types in the cache are looped through from highest to lowest fidelity.
    - iii. If a source is found, weather data variables are linearly interpolated from the cached values to the desired location/time.
    - iv. The interpolated weather variables (temperature, pressure, relative humidity, wind vector) are returned.
  - b. If the high fidelity request did not succeed (lack of data or coverage) the annual average weather associated with the Weather Data instance is returned along with a check for user defined mixing height.

### 2.2.3.2 Terrain Data

#### 2.2.3.2.1 Terrain for Emissions Modeling

When running an emissions metric result, AEDT will use regulatory terrain (assumed perfectly flat) by default. The AEDT Emissions Dispersion Module (EDM) does not currently handle terrain.

#### 2.2.3.2.2 Terrain for Noise Modeling

Varying terrain can greatly affect noise propagation. The terrain feature in AEDT allows for terrain elevation data of the modeling area to be included internally for noise computations. When terrain data are not included, AEDT assumes flat ground at a user-specified receptor elevation. Terrain elevation data are accepted in the following formats: GeoTIFF, National Elevation Dataset (NED) GridFloat, Digital Elevation Model (DEM), and 3CD. The United States Geological Survey (USGS) has announced that they are transitioning their systems to only provide terrain data in GeoTIFF format.

Terrain data are only supported if they are in one of the following projections: NAD83 or WGS84. If the terrain data are not in one of the supported projections, AEDT will produce an error message. Multiple resolutions of data are available among the different formats, and multiple files may be required to cover a desired geographical area.

- GeoTIFF data are available from the United States Geological Survey (USGS) website. For the available elevation datasets, please refer to [https://www.usgs.gov/faqs/what-types-elevation-datasets-are-available-what-formats-do-they-come-and-where-can-i-download?qt-news\\_science\\_products=0#qt-news\\_science\\_products](https://www.usgs.gov/faqs/what-types-elevation-datasets-are-available-what-formats-do-they-come-and-where-can-i-download?qt-news_science_products=0#qt-news_science_products)
- GeoTIFF data are available in many resolutions, but 1/3 arc-second resolution is recommended because it is the highest resolution that has full coverage for the 48 conterminous states and Hawaii. In some areas of Alaska 1/3 arc second data is not available.
- USGS stopped offering NED GridFloat and DEM data, however, AEDT supports these format as a convenience. Information about NED GridFloat and DEM data is available from the USGS website.
- 3CD terrain elevations are three arc-seconds apart. A single 3CD file covers one degree in latitude by one degree in longitude (1201 x 1201 points).

AEDT processes terrain data with the GlobalMapper software<sup>ix</sup> using a nearest neighbor interpolation to evaluate elevations at any given point covered by a given dataset.

#### **2.2.3.3 High-Fidelity Weather Boundary**

A high-fidelity weather boundary is defined as a polygon, with each vertex consisting of a latitude and longitude pair.

When using the RUC/RAP, GEOS, or NCAR high-fidelity weather data, a rectangular boundary is required and is used to limit the area that will be processed with high-fidelity weather data. A boundary is not required for using the MERRA-2 or WRF weather.

#### **2.2.3.4 Demographics**

U.S. Census data are required to generate the population exposure report. For information on downloading the 2020 U.S. Census data, see “Using U.S. Census Bureau Data in AEDT” on the AEDT Support website, Downloads page.

#### **2.2.3.5 Ambient Concentrations for Air Quality Analysis**

Ambient concentrations for the various pollutants are the measurement of the pollution in the atmosphere. This is typically the concentration of the pollutant after it has been emitted from a source and mixing has occurred in the atmosphere. For airport studies, the three key source categories are emissions from airport activities, emissions from other anthropogenic sources (either nearby or from long-range transport), and natural sources. During airport evaluations, ambient, or local concentrations, are determined by either local monitoring or modeling and are directly comparable to the National Ambient Air Quality Standards (NAAQS). When monitoring data are used, specific for the airport, all three source categories are included and the measured values represent a total ambient concentration. AEDT models airport activities and as such the other two source categories must be added to determine

---

<sup>ix</sup> For more details on GlobalMapper, see <https://www.blumarblegeo.com/global-mapper/>

---

the total ambient concentration. The concentration added from the non-airport source categories is usually referred to as the background concentration.

The primary source of background concentration data is from State and Local Ambient Monitoring Stations (SLAMS), but it can also be available from local and state control agencies. The EPA Air Data website at <https://www.epa.gov/outdoor-air-quality-data>, also provides background concentration data from outdoor monitors across the U.S. in multiple formats.

If specific airport measurement data are available, it is most often documented and available from the local airport authority. To completely characterize an airport, especially large airports, measurements must be extensively quality controlled (both spatially and temporally). The EPA provides guidance information at <https://www.epa.gov/amtic>. Monitoring to determine local ambient concentration is often cost prohibitive and not routinely done in the U.S.; therefore, modeling is primarily used to determine ambient concentration.

The NAAQS should be reviewed before selecting the format and appropriate data for any pollutant.

#### ***2.2.3.6 Ambient Background Noise Data for Noise Analyses***

Time-based noise metrics in AEDT require either an ambient threshold or ambient noise files depending on the noise metrics selected. All of these files include geospatial ambient noise data corresponding to a specific study area (and may also reflect specific study or operational conditions). There are two ambient noise file specifications. Both are grids of noise index values, the analogy in digital imagery being a bit map. The difference between the two specifications is the range of the “bit map” or noise index map. One is two digit indices which yields lower noise fidelity, i.e., fewer noise levels. The other is a three digit index yielding higher noise fidelity.

Time Above metrics (TALA, TAPNL, and TALC) can utilize either a two or three digit ambient grid file. Time Audible metrics require a three digit ambient grid file and an ambient spectral map file, which correlates unique spectra to each ambient sound level specified in the ambient grid file. The first file is the three digit ambient grid file, a text grid file that assigns a number, often representing the A-weighted ambient sound level, to study area grid points. The second file is the ambient spectral map file, which correlates unique spectra to the ambient sound levels specified in the ambient grid file.

#### ***2.2.3.7 Application of Ambient Background Noise Data for Time Audible Metrics***

Users needing access to Time Audible (TAUD) metrics are required to submit their ambient data to FAA in accordance with the procedures detailed in the AEDT User Manual<sup>1</sup>. FAA will perform a consistency check on the data and provide a study-specific key to unlock the TAUD functionality in AEDT for each approved ambient data set/study combination submitted. Users are advised to first contact the FAA Office of Environment and Energy for guidance on the applicability of a TAUD analysis to specific aviation proposals. Given:

- a. The anticipated process for collecting ambient data;
- b. The sensitivity of TAUD to ambient data; and

c. The need for consistency between input files,

the FAA will provide a key file that enables the TAUD functionality in AEDT on a per-study basis for use in Federal projects.

### 3. Aircraft Performance

AEDT calculates aircraft performance information (such as flight path, thrust levels, and fuel burn) for terminal-area and runway-to-runway operations. These calculations employ performance models to approximate the state of an aircraft through each full air operation. The calculated performance serves as the primary input to noise and emissions calculations.

#### 3.1 Trajectories

AEDT calculates a complete four-dimensional representation (x, y, z, time) of each segment of the flight path as well as thrust, fuel burn, and emissions mode values. Since the variation of an aircraft's position is included, this progression of aircraft states is called a trajectory.

##### 3.1.1 Properties

A trajectory is approximated by a set of segments. Each segment is associated with one initial and one final instantaneous aircraft state, along with a description of aircraft performance between those states. Given two adjacent segments, the final state of the first segment is equivalent to the initial state of the second segment. Each segment also includes some "nominal" properties, which constitute appropriate descriptions of the overall performance of the segment as a whole (or its surrounding environment).

Table 3-1 Properties and Units of Instantaneous States

Property	Units
Cumulative horizontal distance	m
Time	yr, mo, day, hr, min, s
Altitude with respect to the associated field elevation (AFE)	m
Altitude with respect to mean sea level (MSL)	m
Groundspeed	m/s
Corrected net thrust per engine	N
Mass	kg
Noise thrust	N, %, other (see Section 3.6.2.1)
Projected unit vector	(dimensionless) (see Section 3.9.1.5)
Bank angle (for fixed-wing; positive in a left turn)	degrees
Heading (true from north)	degrees
Latitude	degrees
Longitude	degrees

Table 3-2 Properties and Units of Segments

Property	Units
Horizontal length of segment	m
Change in noise thrust per engine	N, %, other (see Section 3.6.2.1)
Change in speed	m/s
Fuel flow rate per engine	kg/s
Amount of fuel burned (all engines)	kg
Duration	s
Total length of segment	m
Noise operation mode or helicopter mode	(dimensionless, see Section 2.2.1.1)
Trajectory mode	(dimensionless, see Section 5.1)
Nominal Mach number	(dimensionless, see Section 3.9.1.7.1.7)
Nominal dew point temperature	K
Nominal pressure	N/m/m
Nominal relative humidity	%
Nominal temperature	K
Nominal wind direction	degrees
Nominal wind speed	m/s
Nominal Mixing height	m
Nominal Pressure ratio	(dimensionless, see Section 1.4)
Nominal Temperature ratio	(dimensionless, see Section 1.4)

Note that when the computed value of noise thrust is negative, performance analysis sets it to a value of 1 pound-force.

For taxi segments, values for the projected unit vector (unit-x/y/z), segment length, and segment ground speed are calculated the same way these values are calculated for ground roll segments. This is due to the fact that the taxi segments are not modeled using ANP, instead they are modeled using the DSQM module.

### 3.1.2 Targets

Performance in AEDT can be driven by a target flight profile or a target trajectory. Both methods require ground track specification, but the target states provided by profiles are not associated with any specific distances along the track, whereas target trajectories associate desired altitudes (feet MSL) and speeds (KCAS) with the surface coordinates along the track.

Profile-driven flight performance is described in Sections 3.6 and 3.7. Trajectory-driven flight performance is described in Section 3.9.

## 3.2 Flight Performance Models

Flight performance modeling in AEDT is primarily based on recommendations from three flight performance specifications. Each performance specification includes:

- Equations that model:
  - Atmospheric conditions;
  - The physics of flight;
  - Aerodynamic forces as a function of configuration and operating conditions; and
  - Thrust as a function of power settings and operating conditions.
- A dataset of aircraft-specific coefficients for use in the modeling equations.
- A set of standard flight procedures.

The three performance specifications used for AEDT's flight performance model are:

- **International Civil Aviation Organization (ICAO) Doc 9911 (Doc 9911)**<sup>67</sup>. This manual, herein referred to as Doc 9911, provides internationally agreed instructions for computing noise contours around airports based on current (as of 2018) noise information and performance methods. It provides an update to the methods defined in the Society of Automotive Engineers (SAE) Aerospace Information Report (AIR) No. 1845<sup>3</sup> (SAE-AIR-1845), and it contains content equivalent to European Civil Aviation Conference (ECAC) Doc 29<sup>70</sup>. The dataset associated with this model is the Aircraft Noise and Performance (ANP) database<sup>13</sup>. The "ANP and BADA 3" performance option in AEDT is compliant with SAE-AIR-1845, ECAC Doc 29, and ICAO Doc 9911.
- **EUROCONTROL's User Manual for BADA Family 3 (BADA 3)**<sup>20</sup>. The dataset associated with this model is the BADA Family 3 database. This model was developed for use in all phases of flight, but its primary strength is in modeling en-route phases. Note that it includes a fuel consumption model, which is discussed in Section 3.4.1.
- **EUROCONTROL's BADA Family 4 (BADA 4)**<sup>14</sup>. The dataset associated with this model is the BADA Family 4 database. Compared to BADA 3, the BADA 4 model and supporting data are of higher fidelity, and additional en-route flight methodologies are presented. Like BADA 3, the BADA 4 model was developed for use in all phases of flight, and it is as well-suited to most portions of terminal-area phases as it is to en-route phases. BADA 4 also includes a fuel consumption model. Additional background information on the BADA 4 model (including the fuel consumption aspect) is given in Section 12 Appendix – BADA 4 Model.

In this manual, discussions of analysis according to a particular model generally implies that the analysis is performed using the equations from that model. For example, the term "BADA 4 analysis" refers to using primarily the equations set forth in the BADA 4 performance specification (and BADA 4 data) to compute flight performance. When an equation presented in this manual is reproduced from a performance specification, the equation's source is indicated.

AEDT supports use of these component flight performance models in two ways:

- Doc9911-BADA3: Doc 9911 is used in the terminal area, while BADA 3 is used en-route.
- Doc9911-BADA4: Doc 9911 is used for initial segments<sup>x</sup>, while BADA 4 is used everywhere else.

---

<sup>x</sup> When BADA 4 data are incomplete, AEDT substitutes ANP data as discussed below.

Detailed descriptions of the analysis of terminal area procedures are given in Section 3.6 (using the Doc 9911 model) and Section 3.7 (using the BADA 4 model). Detailed descriptions of trajectory-driven flight performance analysis for all three models are presented in Section 3.9.

When using Doc 9911 and BADA 3 analysis for an operation in which aircraft altitude spans both terminal-area and en-route ranges, the model used for flight mechanics switches between Doc 9911 and BADA 3 at the top of the terminal area. The point at which this happens is sometimes referred to as the “Doc9911-BADA3 transition”. These are discussed in further detail in Sections 3.6.2.8, 3.6.2.9, 3.9.1.5, 3.9.1.7.2, and 3.9.1.7.3.2. When using BADA 4 analysis, the corresponding “Doc9911-BADA4 transitions” are at the end of initial flight segments and the beginning of landing segments<sup>x</sup>.

The BADA 3, BADA 4, and ANP databases each include modeling data for limited sets of equipment combinations (airframe, engine model, and engine modifications). For most equipment combinations, modeling data specific to the combination is not available. For each equipment combination that AEDT supports, it provides suitable corresponding ANP and BADA 3 datasets that can be expected to best approximate that combination. For many equipment combinations, AEDT also provides a suitable corresponding BADA 4 dataset. One or more of the cited ANP, BADA 3, or BADA 4 datasets will sometimes be based on the given equipment combination, but they will generally all be based on different combinations.

### 3.3 Weather Model

The variation of atmospheric conditions and wind over a given domain in space and time constitutes a weather field. Although the Doc 9911 performance model specifies the ISA for its weather model, AEDT uses a model that allows for customization of weather conditions based on high-fidelity or airport-specific average weather data.

#### *Weather Model for RUC/RAP, GEOS, and NCAR*

For RUC/RAP, GEOS, and NCAR weather data types, AEDT assigns an order of precedence to the types of weather data it supports, so that when a weather value is required at a given location and time, the data are taken from the highest-ranked sources that encompass the coordinate. Where these domains overlap, the weather field is a cascade of sources of weather data that the user makes available in formats as described in Section 2.2.3.1. For more information regarding meteorological data processing associated with air quality dispersion modeling, please refer to Section 6.9.

The hierarchy of weather data sources is traversed for every required location and time. When a location and time is specified, AEDT first checks whether there are RUC13/RAP13 data<sup>xi</sup> available at the requested location and time. If there are, then the weather at that location and time is taken from that dataset. If not, then it goes through the same process for RUC20/RAP20 data. The cycle continues for GEOS data, then NCAR data, and finally airport average annual weather. AEDT will first attempt to use the annual average weather of the annualization year, and if that’s not available it will use the 10-year average weather. If no data are available for the given location and time from any of these sources, ISA weather is used. This cascade of weather data sources is illustrated in Figure 3-1.

---

<sup>xi</sup> RAP data is the next-generation version of the RUC and officially replaced RUC in May 2012.



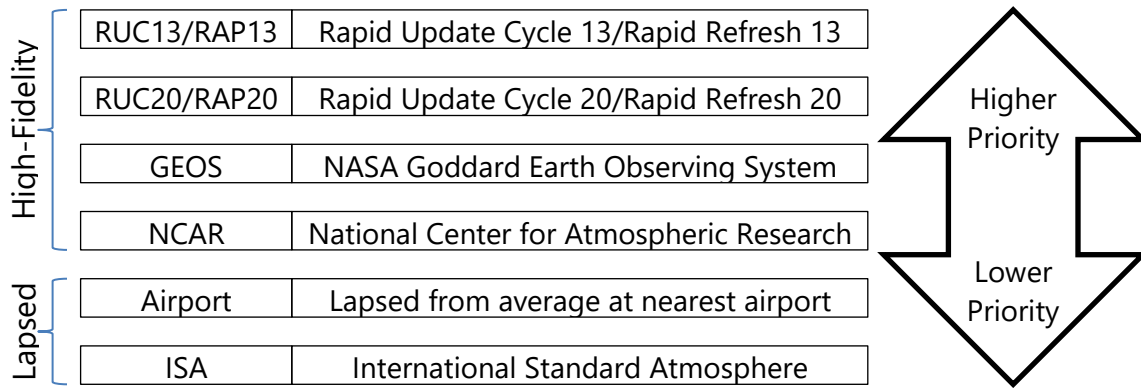

Figure 3-1 Cascade of Weather Data Sources

**Weather Model for MERRA-2 and WRF**

WRF and MERRA-2 high fidelity weather data are handled differently compared to RUC/RAP, GEOS, and NCAR. The cascade of weather data sources method is not applied to WRF and MERRA-2. This means that if there are no WRF/MERRA-2 data available at the requested location and time, the affected aircraft operation will fail, and an error will be logged. AEDT does not substitute missing WRF/MERRA-2 data with average annual airport weather.

For MERRA-2, the grid resolution is based on 0.5 degrees in latitude and 0.625 degrees in longitude. This corresponds to around 50 km x 50 km. GEOS is 0.5 degrees in latitude and 2/3 = 0.66... degrees in longitude. Thus MERRA-2 is close to GEOS resolution.

AEDT can process WRF data in Lambert Conformal Conic (LCC) Projection. For WRF, 12 km or 36 km grid resolution is common.

**3.3.1 ISA Weather Model**

The ISA weather model provides atmospheric conditions in the troposphere and the stratosphere, demarcated by the altitude of the tropopause, defined at 11 km (36,089.24 ft.) for ISA conditions. The temperature and pressure at altitude are determined in accordance with section 3.2 of the User Manual for the Base of Aircraft Data (BADA) revision 3.6<sup>74</sup>. Methods for the troposphere are applied below the tropopause and methods for the stratosphere are applied at and above the tropopause, up to 20 km.

**3.3.1.1 Pressure Altitude**

Pressure altitude is defined as the MSL altitude (feet) in an ISA at which a given pressure or pressure ratio occurs. Below the tropopause, AEDT calculates pressure altitude,  $h_p$ , for a given pressure ratio,  $\delta$ , by the equation:

$$h_p = \left( \frac{T_{SLISA}}{\alpha_{ISA}} \right) \cdot (1 - \delta^{\alpha_{ISA}R}) \tag{Eq. 3-1}$$

where

$h_p$  Pressure altitude (ft);

$T_{SLISA}$	ISA sea-level temperature 518.67 °R;
$R$	Gas constant for air (53.35 ft/°R)
$\alpha_{ISA}$	ISA temperature lapse rate 0.003566 °R/ft; and
$\delta$	Pressure ratio at aircraft altitude (dimensionless).

At and above the tropopause, up to 20 km, AEDT calculates pressure altitude,  $h_p$ , by the equation:

$$h_p = h_{Trop} - \left[ (RT_{Trop}) \left( \ln \left( \frac{P}{P_{Trop}} \right) \right) \right] \quad \text{Eq. 3-2}$$

where

$T_{Trop}$	Constant ISA temperature above the tropopause 389.97 °R;
$h_{Trop}$	Altitude of the tropopause ft;
$P$	Pressure at altitude inches Hg;
$P_{Trop}$	Pressure at the tropopause inches Hg.

### 3.3.1.2 Temperature Deviation from ISA

Temperature deviation from ISA is defined as the difference between the actual temperature at a given location and time and the temperature in the ISA.

$$\Delta T(x, y, z, t) = T(x, y, z, t) - T_{ISA}(z) \quad \text{Eq. 3-3}$$

where

$\Delta T(x, y, z, t)$	Temperature deviation from ISA as a function of location and time (K);
$T(x, y, z, t)$	Temperature as a function of location and time (K); and
$T_{ISA}(z)$	ISA temperatures as a function of altitude (K).

Temperature deviation from ISA is used in calculations discussed in Section 3.9.1.7.1.

### 3.3.1.3 ISA Weather Thermodynamic Profiles and Wind

When the ISA is selected as the desired weather model for an analysis, the weather is modeled as a special case of an airport-average atmospheric model, as described in Section 3.3.2. The standard sea-level conditions of the ISA are used as the "airport" reference values for the thermodynamic profile modeling discussed in Section 3.3.2.1. The wind is modeled as an invariant 8 knots headwind throughout all space and time, with its direction modeled as described in Section 3.3.2.2.

## 3.3.2 Airport Average Atmospheric Models

The Airport weather model provides atmospheric conditions in the troposphere and the stratosphere, demarcated by the altitude of the tropopause, defined for the airport weather case by equation .

$$h_{trop} = 36,089.24 + \Delta T_{ISA} / \alpha_{ISA} \quad \text{Eq. 3-4}$$

where

$\alpha_{ISA}$	ISA temperature lapse rate 0.003566 °R/ft; and
----------------	--

$\Delta T_{ISA}$  The difference between airport temperature at sea level and ISA temperature at sea level ( $^{\circ}\text{R}$ ).

The temperature and pressure at altitude are determined in accordance with section 3.2 of the User Manual for the Base of Aircraft Data (BADA) revision 3.6. Methods for the troposphere are applied below the tropopause and methods for the stratosphere are applied at and above the tropopause, up to 20 km.

### 3.3.2.1 AEDT Thermodynamic Profiles

Reference values for thermodynamic properties (temperature and pressure) internally calculated by AEDT are given at specified altitudes, and atmospheric profiles are constructed to fit those data in a physically realistic manner, similar to the manner in which the ISA was derived. These quantities are a function of altitude. In AEDT, the reference temperatures and pressures are 10-year annual average values associated with an airport relevant to the flight. There is no variation with respect to surface coordinate or time.

#### Temperature

Below the tropopause, temperature,  $T$  ( $^{\circ}\text{R}$ ), at a given altitude,  $h$  (with respect to mean sea-level), is calculated by the equation:

$$T = T_{airport} - \alpha_{ISA} \cdot (h - h_{airport}) \quad \text{Eq. 3-5}$$

where

$h_{airport}$  Airport elevation above MSL (ft);  
 $h$  Altitude above MSL (ft);  
 $T_{airport}$  Airport temperature ( $^{\circ}\text{R}$ ); and  
 $\alpha_{ISA}$  ISA temperature lapse rate 0.003566  $^{\circ}\text{R}/\text{ft}$ .

At and above the tropopause, the temperature is a constant and equal to 216.65 K. (389.97  $^{\circ}\text{R}$ ).

#### Pressure

Below the tropopause, pressure,  $P$  (inches Hg), is calculated by the equation:

$$P = P_{SLISA} \left[ \left( \frac{P_{SL}}{P_{SLISA}} \right)^{\frac{1}{5.256}} - \frac{\alpha}{T_{SLISA}} h \right]^{5.256} \quad \text{Eq. 3-6}$$

where

$P_{SL}$  Sea-level pressure associated with the airport (inches Hg);  
 $P_{SLISA}$  ISA sea-level pressure 29.92 inches Hg; and  
 $T_{SLISA}$  ISA sea-level temperature 518.67  $^{\circ}\text{R}$ .

At the tropopause, pressure,  $P$  (inches Hg), is calculated by the equation:

$$P_{trop} = P_{SLISA} \left[ \left( \frac{P_{SL}}{P_{SLISA}} \right)^{\frac{1}{5.256}} - \frac{\alpha}{T_{SLISA}} h_{trop} \right]^{5.256} \quad \text{Eq. 3-7}$$

Above the tropopause at height  $h$ , the pressure,  $P$  (inches Hg), is calculated by the equation:

$$P = P_{trop} \exp \left[ \left( \frac{-1}{RT_{trop}} \right) (h - h_{trop}) \right] \quad \text{Eq. 3-8}$$

where

$h_{trop}$  Height of the tropopause (ft)

### 3.3.2.2 Airport-Based Wind Modeling

#### 3.3.2.2.1 Airport-Based Wind Speed

In the airport-average atmospheric model of AEDT (including the special case of the ISA), wind has a constant speed, based on an average windspeed value associated with the nearest airport, with no variation with respect to altitude. If the nearest airport has no windspeed value available, a default of 8 knots is used as the basis.

AEDT scales airport-based wind speeds by a multiplier associated with the runway end corresponding to the operation:

$$w_S = \left( \frac{100 + \chi}{100} \right) w_A \quad \text{Eq. 3-9}$$

where

$w_S$  Scaled headwind magnitude;  
 $w_A$  Headwind associated with the airport; and  
 $\chi$  Runway end's wind adjustment percentage.

This scaling allows different headwinds to be associated with different runway ends. This functionality might be used, for example, to roughly emulate the effect of an airport configurations; runways that are expected to be aligned against the prevailing winds can be assigned large multipliers, while runways that are expected to be aligned more askew of prevailing winds can be assigned small multipliers.

#### 3.3.2.2.2 Airport-based Wind Direction

AEDT does not have average wind direction data for airports. Generally, airport-based wind direction is modeled by AEDT as continually against the course of the aircraft (i.e., always a pure headwind, regardless of the direction of travel). The exception is Doc 9911-BADA 4 analysis of a departure, arrival, touch-and-go, or circuit operation, where the wind direction is continually taken to be against the direction of the associated runway.

### 3.3.3 High-Fidelity Weather Model

AEDT supports a high-fidelity model of weather that allows variation of all atmospheric properties (temperature, pressure, wind magnitude and direction, density, dew point, and relative humidity) along all three spatial dimensions, as well as in time. This is done by reading and linearly interpolating (sometimes extrapolating) weather data defined on 4-D grids. These grids are supplied by the user as files from sources described in Section 2.2.3.1. The data are defined on grids that are regularly spaced in time and along geographic coordinate systems (latitude/longitude or projection, depending on the data), but irregularly spaced along the vertical direction.

## 3.4 Fuel Consumption Models

For fixed-wing aircraft, AEDT calculates the fuel consumed over each flight path segment by one of two methods. The first method, available in either the terminal or the en-route areas, calculates the fuel consumption for each flight segment in accordance with Section 3.9 of the BADA 3 User Manual<sup>20</sup> (refer to Section 3.4.1). The second method, available only in the terminal area, calculates the fuel consumption for each segment in accordance with the Senzig-Fleming-Iovinelli (SFI) method<sup>21,22</sup> (refer to Section 3.4.2). Above the terminal area, AEDT uses the BADA 3 method. A third method is used for fixed-wing aircraft which do not have thrust data in their performance calculations; for these aircraft AEDT uses Boeing Fuel Flow Method 2 (BFFM2 – Section 5.1.1.1) to determine fuel flow. The majority of aircraft using AEDT's implementation of the BFFM2 method are military airframes; however, civil aircraft which do not use thrust as a parameter in their profile definitions also utilize this method to calculate fuel flow. In addition, all fixed-wing taxi operations use the BFFM2 method per SAE-AIR-8045<sup>5</sup>.

The BADA 4 fuel consumption model is described in Section 12.3.2.2 Fuel Consumption Model.

For helicopters, AEDT calculates the fuel consumed over each flight path segment using a time-in-mode fuel consumption method (refer to Section 3.4.4). AEDT uses the same method in the terminal and en-route areas.

Note that all of these methods specify the fuel flow rate. For the SFI and BFFM2 methods, AEDT calculates the amount of fuel consumed in a segment by multiplying the fuel flow rate per engine by the segment duration and the aircraft's number of engines. For the BADA 3 method, AEDT calculates the amount of fuel consumed in a segment by multiplying the fuel flow rate for all engines by the segment duration.

The SFI, BFFM2, and BADA 3 fuel consumption methods are part of the SAE-AIR-6183<sup>6</sup> standard.

### 3.4.1 Fixed-Wing BADA 3 Fuel Consumption

The BADA 3 fuel consumption model provides expressions for the nominal fuel flow rate. These expressions depend on the engine type (turbofan, turboprop, or piston), the aircraft's phase of flight (e.g., en-route climb, en-route descent, or cruise), and the engine's operating condition (e.g., nominal or idle thrust).

### 3.4.1.1 Fixed-Wing BADA 3 Fuel Consumption – Turbofan engines

The nominal total rate of fuel flow  $f_{nom}$  (kg/minute) for an aircraft, which is applicable for all situations where the aircraft is neither in the cruise phase of flight nor operating at an idle thrust setting, is given by:

$$f_{nom} = \left(1 + \frac{V_T}{C_{f_2}}\right) C_{f_1} F \quad \text{Eq. 3-10}$$

where

- $V_T$  Aircraft true airspeed (speed in the air mass frame of reference) (kt);
- $C_{f_1}$  Aircraft-specific 1st thrust specific fuel consumption coefficient (kg/min/kN);
- $C_{f_2}$  Aircraft-specific 2nd thrust specific fuel consumption coefficient (kt); and
- $F$  Aircraft total net thrust from its engines (kN).

The BADA 3 total fuel flow rate  $f_{min}$  (kg/minute) for a turbofan aircraft in an idle state is given by:

$$f_{min} = \left(1 - \frac{h}{C_{f_4}}\right) C_{f_3} \quad \text{Eq. 3-11}$$

where

- $h$  Altitude above MSL (ft);
- $C_{f_3}$  Aircraft-specific 1st descent fuel flow coefficient (kg/min); and
- $C_{f_4}$  Aircraft-specific 2nd descent fuel flow coefficient (ft).

### 3.4.1.2 Fixed-Wing BADA 3 Fuel Consumption – Turboprop engines

The nominal total rate of fuel flow  $f_{nom}$  (kg/minute) for a turboprop aircraft, which is applicable for all situations where the aircraft is neither in the cruise phase of flight nor operating at an idle thrust setting, is given by:

$$f_{nom} = \left(1 - \frac{V_T}{C_{f_2}}\right) \frac{C_{f_1}}{1,000} V_T F \quad \text{Eq. 3-12}$$

where

- $V_T$  Aircraft true airspeed (speed in the air mass frame of reference) (kt);
- $C_{f_1}$  Aircraft-specific 1st thrust specific fuel consumption coefficient (kg/min/kN/kt);
- $C_{f_2}$  Aircraft-specific 2nd thrust specific fuel consumption coefficient (kt); and
- $F$  Aircraft total net thrust from its engines (kN).

The BADA 3 total fuel flow rate  $f_{min}$  (kg/min) for a turboprop aircraft in an idle state is given by:

$$f_{min} = \left(1 - \frac{h}{C_{f_4}}\right) C_{f_3} \quad \text{Eq. 3-13}$$

where

$h$	Altitude above MSL (ft);
$C_{f_3}$	Aircraft-specific 1st descent fuel flow coefficient (kg/min); and
$C_{f_4}$	Aircraft-specific 2nd descent fuel flow coefficient (ft).

### 3.4.1.3 Fixed-Wing BADA 3 Fuel Consumption - Piston engines

The nominal total rate of fuel flow  $f_{nom}$  (kg/minute) for a piston-engine aircraft, which is applicable for all situations where the aircraft is neither in the cruise phase of flight nor operating at an idle thrust setting, is given by:

$$f_{nom} = C_{f_1} \quad \text{Eq. 3-14}$$

where

$C_{f_1}$	Aircraft-specific fuel flow coefficient (kg/min).
-----------	---

The BADA 3 total fuel flow rate  $f_{min}$  (kg/min) for an aircraft in an idle state is given by:

$$f_{min} = C_{f_3} \quad \text{Eq. 3-15}$$

where

$C_{f_3}$	Aircraft-specific descent fuel flow coefficient (kg/min).
-----------	---

### 3.4.1.4 Fixed-Wing BADA 3 Fuel Consumption - Cruise State

The BADA 3 total fuel flow rate  $f_{CR}$  (kg/min) for a fixed-wing aircraft in a cruise state is calculated by scaling the nominal flow rate:

$$f_{CR} = C_{f_{CR}} f_{nom} \quad \text{Eq. 3-16}$$

where

$C_{f_{CR}}$	Aircraft-specific cruise fuel flow correction coefficient (dimensionless); and
$f_{nom}$	Nominal total rate of fuel flow (kg/min).

The cruise state is defined slightly differently in each of the trajectory modes (Section 3.1). In the Official Airline Guide (OAG) trajectory mode, AEDT defines the cruise state as all segments between Top of the Climb (TOC, where the aircraft first ends the initial en-route climb from the departure airport) and the Top of Descent (TOD, where the aircraft first begins the en-route descent to the arrival airport). In the radar and sensor path modes, AEDT defines the cruise state as any segment which has a climb or descent rate less than the threshold rate of 20 feet per minute. In the ANP extension mode, AEDT applies the cruise correction to those level segments which extend the trajectory to the boundary of the study area.

### 3.4.2 Fixed-Wing Senzig-Fleming-Iovinelli Fuel Consumption - Turbofan engine

In the SFI method, the terminal area thrust specific fuel consumption method for the operational type (departures or arrivals) is used. The SFI methods are only used for turbofan engines in the terminal area.

#### 3.4.2.1 SFI Fuel Consumption - Turbofan engine, departure

For the SFI method, fuel flow rate per engine during departure  $f_{n_{dep}}$  (kg/min/eng) is calculated as:

$$f_{n_{dep}} = (K_1 + K_2M + K_3h_{MSL} + K_4F_n / \delta)\sqrt{\theta}F_n \quad \text{Eq. 3-17}$$

where

$K_1$	Aircraft-specific terminal-area departure TSFC constant coefficient (kg/min/kN),
$K_2$	Aircraft-specific terminal-area departure TSFC Mach coefficient (kg/min/kN),
$K_3$	Aircraft-specific terminal-area departure TSFC altitude coefficient (kg/min/kN/foot),
$K_4$	Aircraft-specific terminal-area departure TSFC thrust coefficient (kg/min/kN/lb);
$h_{MSL}$	Aircraft altitude (ft, MSL);
$M$	Aircraft Mach number (dimensionless);
$\theta$	Ratio of temperature at aircraft altitude to sea level ISA temperature (dimensionless);
$F_n / \delta$	Aircraft corrected net thrust per engine (lbf); and
$F_n$	Aircraft net thrust per engine (kN).

#### 3.4.2.2 SFI Fuel Consumption - Turbofan engine, arrival

For the SFI method, fuel flow rate per engine during arrival  $f_{n_{arr}}$  (kg/min/eng) is calculated as:

$$f_{n_{arr}} = \left( \alpha + \beta_1M + \beta_2e^{-\left(\frac{\beta_3F_n/\delta}{F_{n_0}}\right)} \right) \sqrt{\theta}F_n \quad \text{Eq. 3-18}$$

where

$\alpha$	Aircraft-specific terminal-area arrival TSFC constant coefficient (kg/min/kN);
$\beta_1$	Aircraft-specific terminal-area arrival TSFC Mach coefficient (kg/min/kN);
$\beta_2$	Aircraft-specific terminal-area arrival TSFC thrust coefficient (kg/min/kN);
$\beta_3$	Aircraft-specific terminal-area arrival TSFC thrust ratio coefficient (dimensionless);
$M$	Aircraft Mach number (dimensionless);
$\theta$	Ratio of temperature at aircraft altitude to sea level ISA temperature (dimensionless);
$F_n / \delta$	Aircraft corrected net thrust per engine (lbf);
$F_n$	Aircraft net thrust per engine (kN); and
$F_{n_0}$	ISA sea-level static thrust (lbf).

### 3.4.3 BFFM2 Fixed-Wing Fuel Consumption

AEDT uses Boeing Fuel Flow Method 2 (BFFM2) when other sources for fuel consumption data are not available, e.g., the required SFI or BADA 3 data don't exist for the particular aircraft, or thrust is not a parameter in the aircraft's performance profile. The BFFM2 method is:



$$W_f = \frac{B_m R W_f \delta}{\theta^{3.8} e^{0.2 M^2}} \quad \text{Eq. 3-19}$$

where

$W_f$	Fuel flow at non-reference conditions (kg/s);
$B_m$	Modal-specific adjustment factors (dimensionless);
$R W_f$	Fuel flow at reference conditions (kg/s);
$M$	Mach number (dimensionless);
$\theta$	Static Temperature ratio (ambient to sea level standard - dimensionless); and
$\delta$	Static Pressure ratio (ambient to sea level standard- dimensionless).

The fuel flow at reference conditions used in the BFFM2 are the fuel flow data found in the ICAO Aircraft Engine Emissions Databank (EEDB<sup>12</sup>). Note that these are per engine fuel flows, not per aircraft. The modal-specific adjustment factors are listed in Table 5-1 below; these factors account for the effect of the operation of the aircraft's Environmental Control System (ECS) on the engine's compressor bleed air flow. These ECS adjustments are required since the fuel flow measurements for certification in the ICAO emission database are conducted without the compressor bleed air flow which drives the ECS.

As with the SFI methods, the total BFFM2 fuel consumption for a particular segment is the product of the fuel flow per engine during that segment, the segment's duration, and the number of engines on the aircraft.

### 3.4.3.1 BFFM2 Fixed-Wing Fuel Consumption – Taxi Segments

The BFFM2 method used in AEDT for taxi segments is a modification of the BFFM2 model used for other modes, assuming delta and theta are both 1.0 and Mach number is zero, by applying a taxi-specific adjustment factor per SAE AIR-8035:

$$\dot{m}_{f_{Taxi}} = B_m \dot{m}_{f_{ICAO\ 7\% \text{ Setting}}} \quad \text{Eq. 3-20}$$

where

$\dot{m}_{f_{Taxi}}$	Fuel flow at non-reference conditions (kg/s);
$B_m$	Modal-specific adjustment factor (dimensionless) with a value of 1.1;
and	
$\dot{m}_{f_{ICAO\ 7\% \text{ Setting}}}$	Fuel flow rate at reference condition (7 percent idle power setting) (kg/s).

The fuel flow at reference condition for taxi modeling is the per engine fuel flow from the ICAO Engine Emissions Databank (EEDB) as is the case with BFFM2 modeling for other modes.

As with the SFI methods, the total BFFM2 fuel consumption for a particular segment is the product of the fuel flow per engine during that segment, the segment's duration, and the number of engines on the aircraft.

Eq. 3-21

Equations Eq. 3-20 is used regardless if taxi times are determined by the delay and sequencing model or by time in mode.

#### 3.4.4 Helicopter Fuel Consumption

AEDT uses a helicopter's engine-specific fuel flow rate that corresponds to the "climbout" ICAO operation mode (85 percent of maximum power). AEDT assigns this engine-specific climb-out fuel flow rate to all operational modes.

Helicopters are typically powered by turboshaft or piston engines. ICAO does not require the manufacturers of these relatively small engines to supply data for the Emission Databank (EEDB<sup>12</sup>). The AEDT Fleet database provides a field in the fleet engine data table which describes the source of data for each record, including those for helicopter engines.

Because the helicopter terminal area profile calculations are modal rather than force-based, and unlike predictions for fixed-wing aircraft, the dynamic helicopter weight that results from decrementing the weight by the amount of fuel consumed over each flight path segment does not impact the calculated flight path or other performance parameters.

### 3.5 Ground Track

Ground tracks determine the lateral component of the path followed by an aircraft. They are ultimately represented by an ordered series of 2-D surface locations.

Surface locations can be expressed as either geographic coordinates or projected coordinates. Geographic coordinates are latitude and longitude values. Projected coordinates are Euclidean  $x$  and  $y$  values, representing displacement to the east and north, respectively, from a single centering geographic coordinate (the origin of the projected coordinate system). AEDT uses the conic projection approximation described in Section 15 Appendix – Map Projection Method to model the relationship between the geographic and projected representation of a point. Except where otherwise stated, AEDT performance calculations take place in the projected coordinate space (in place of any geographic coordinates encountered, projected counterparts are created and used). Note that projected geometric distortions grow as horizontal distance from the projection origin increases, so ground track content far from the associated airport, as might be defined for a regional study, is modeled with reduced accuracy.

#### 3.5.1 Ground Track Definition and Computation

A ground track in AEDT is defined in one of two ways:

- "Pointwise" tracks; defined as an ordered set of geographic surface coordinates; or
- "Vector" tracks; defined as an ordered set of vectoring commands (for example, fly straight 5.5 nmi, turn left 90 degrees at a radius of 2.0 nmi).

In either case, a ground track definition also includes:

- Type of air operation supported by the track
- The projection origin:

- The associated airport reference point serves as the projection origin for most operation types (airport definitions in AEDT include the nominal location of the airport).
- Overflight tracks are an exception, since they are not associated with an airport; in this case, the first track point serves as the projection origin (note that overflight tracks must be pointwise; vector overflight tracks are not supported by AEDT).
- If the supported operation type is not overflight, the associated runway's:
  - Geometry (location of the physical runway ends), and
  - Displaced threshold distance from runway end
- "Delta distance" by which to adjust certain track points that would typically coincide with the displaced threshold

AEDT combines all of the information from the track definition to compute a sequence of projected lateral coordinates along which performance results are constrained.

Certain points in computed AEDT tracks play special roles in supporting the trackwise alignment of flight profiles. These points, called "track anchors," are constructed by the system. A track's anchor can establish the point along the track where a profile begins, the point along the track where a profile in descent reaches the approach threshold crossing height, or both. These profile features are usually aligned to the runway's end or runways displaced thresholds location, and track anchors are nominally located at those thresholds, but with adjustments made according to the track's delta distance. More detailed information about how anchors are located for each track type follow below. More detailed information about how profiles are aligned to tracks according to anchors can be found in Section 3.6.2.1.

The following discussion outlines how AEDT computes tracks based on track definitions. Illustrations to support this discussion have the following common features:

- Circles represent track points, either directly from the track definition or generated by AEDT.
- Solid circles/arrows represent points/vectors from the track definitions.
- Dashed circles/arrows represent points/segments created by the system.
- $D_i$  labels the  $i^{\text{th}}$  point/vector in the track definition.
- $n$  is the number of points/vectors in the track definition.
- $\Delta$  is the track's "delta distance" specified by the user to adjust the runway's standard displaced threshold distance.

The relationship between defined and computed pointwise departure track points is illustrated in Figure 3-2. The first two points in the definition are meant to overlap the two runway ends (though, as shown, they need not necessarily do so), followed by any number of additional track points. The first point in the track definition is ignored by the track computation. Instead, the first point of the computed track is the anchor point constructed by AEDT on the runway, a distance  $\Delta$  from the departure threshold location. This is followed by computed copies of the remaining defined track points (except for the first one). The last computed track point is computed by AEDT to be 100 nmi beyond the final defined point, along the heading between the final two defined points.

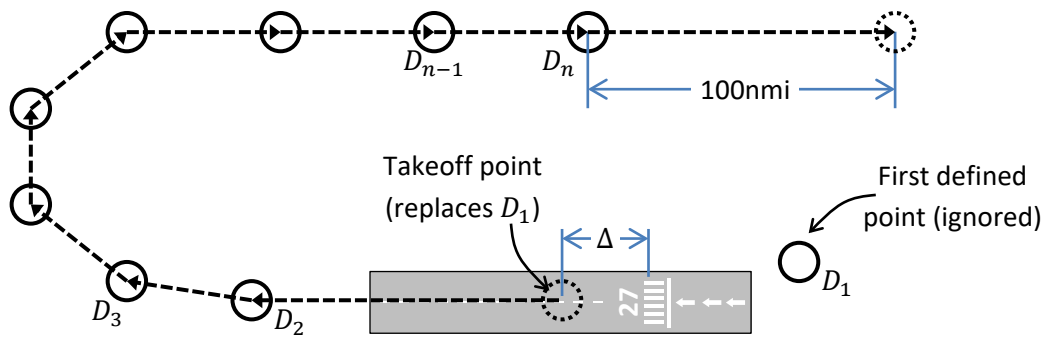

Figure 3-2 Track Computation – Pointwise Departure Track

The relationship between defined vector commands and computed vector departure track points is illustrated in Figure 3-3. The commands are meant to direct the track to proceed straight along the runway, followed by user-defined vectoring instructions. The first point of the computed track overlaps the departure threshold, with an offset of  $\Delta$ . Additional points are then computed reflecting the sequence of vectoring commands. The last computed track point is computed by AEDT to be 100 nmi beyond the final point generated from vector commands, along the heading between the final two points generated from vector commands.

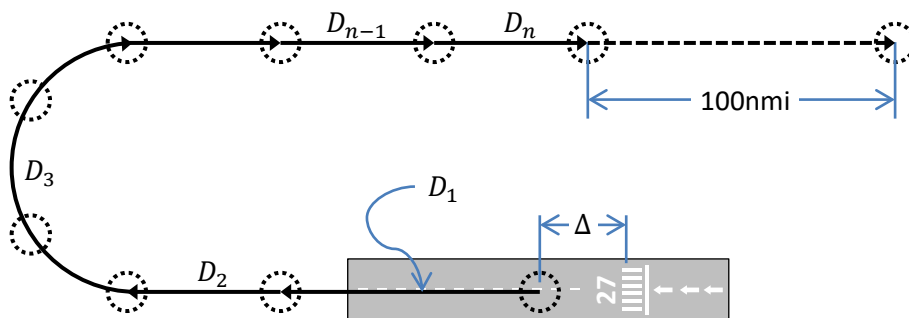

Figure 3-3 Track Computation – Vector Departure Track

The relationship between defined and computed pointwise approach track points is illustrated in Figure 3-4. The definition begins with any number of track points, with the final point intended to overlap the first runway end (though, as shown, it need not necessarily do so). The first computed track point is computed by AEDT to precede the first defined point by 100 nmi, along the heading between the first two defined points. This is followed by computed copies of all defined track points, except for the last one. The last point in the track definition is ignored by the track computation. Instead, the next point in the computed track is the anchor point constructed by AEDT on the runway, a distance  $\Delta$  from the approach threshold location. The last track point computed by AEDT is beyond the approach threshold by the length of the runway, along the heading of the runway.

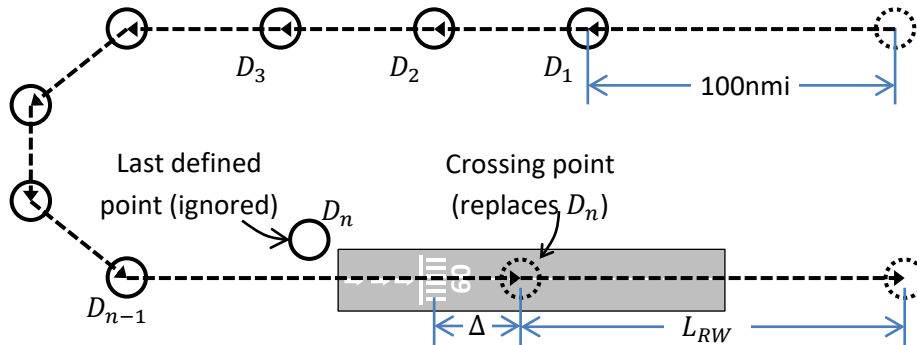

Figure 3-4 Track Computation – Pointwise Approach Track

The relationship between defined vector commands and computed vector approach track points is illustrated in Figure 3-5. The commands are meant to direct the track along user-defined vectoring instructions, followed by a straight approach that ends at the approach threshold. The first computed track point is computed by AEDT to precede the beginning of the first vectoring command by 100 nmi, along the heading between the first two points computed for that command. Additional points are then computed reflecting the sequence of vectoring commands, with the track point corresponding to the end of the final command overlapping the approach threshold. The last track point is computed by AEDT to be beyond the approach threshold by the length of the runway, along the heading of the runway.

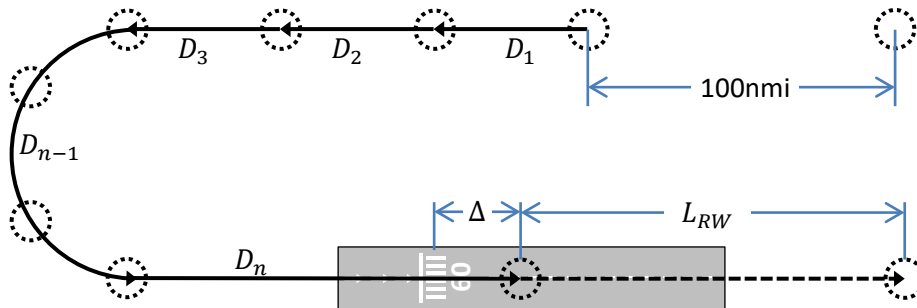

Figure 3-5 Track Computation – Vector Approach Track

The relationship between defined and computed pointwise overflight tracks is illustrated in Figure 3-6. The computed track begins with points at all locations from the track definition. The last point of the computed track is 100 nmi beyond the final defined point, along the direction of the final two defined points.

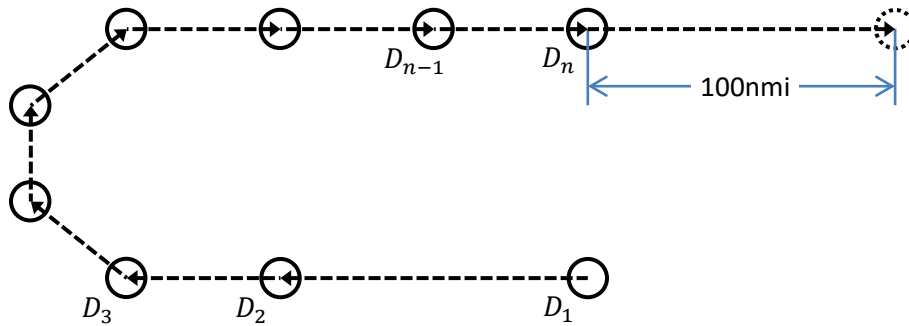

Figure 3-6 Track Computation – Pointwise Overflight Track

The relationship between defined and computed pointwise circuit/touch-and-go tracks is illustrated in Figure 3-7. The first two points in the definition are meant to overlap the two runway ends (though, as shown, they need not necessarily do so), followed by any number of additional points over which the aircraft is meant to pass, with the final defined point overlapping the first. The first point in the track definition is ignored by the track computation. Instead, the first point of the computed track is the anchor point constructed by AEDT on the runway, at a distance  $\Delta$  further along than the approach threshold. This anchor is where the profile will reach the approach threshold crossing height, and where a circuit profile will begin takeoff ground roll. This is followed by points at all locations from the track definition, except for the first and last. The last point in the track definition is ignored by the track computation. Instead, the last point of the computed track overlaps the anchor point.

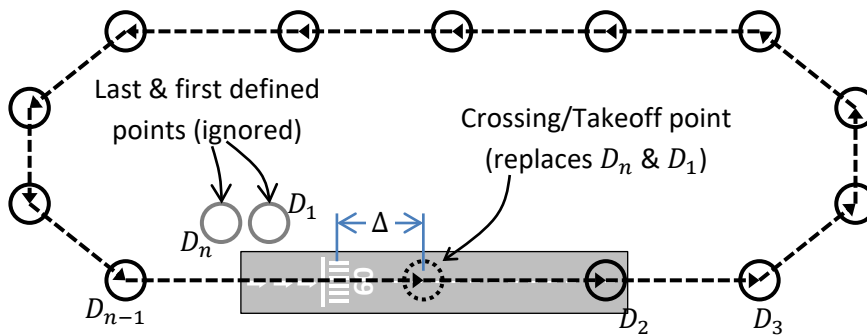

Figure 3-7 Track Computation – Pointwise Circuit/TGO Track

The relationship between defined and computed vector circuit/touch-and-go tracks is illustrated in Figure 3-8. The commands are meant to proceed straight along the runway, followed by arbitrary vectoring behavior that ends at the beginning of the first command. The first point of the computed track overlaps the approach threshold. This is followed by additional points reflecting the behavior indicated by the defined sequence of vectoring commands, ending at the approach threshold.

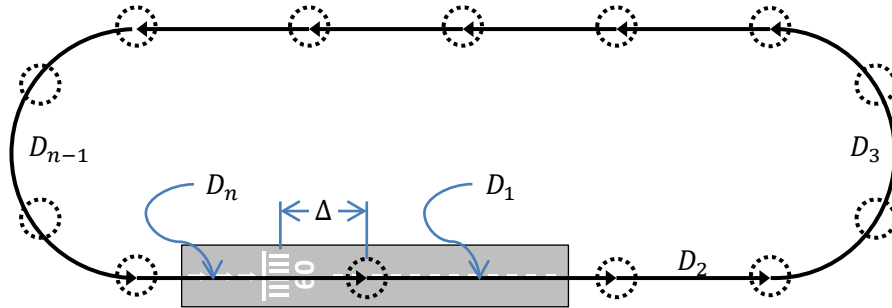

Figure 3-8 Track Computation – Vector Circuit/TGO Track

### 3.5.2 Points from Vectors

AEDT transforms the vectoring commands into a set of projected coordinates. To transform vectors into points, AEDT approximates turning segments by multiple straight segments, ensures that tracks line up with runways as appropriate, adds leader lines to approach tracks, and adds follower lines to departure tracks.

When processing an approach vector track, there is no information available *a priori* about the track's initial location or direction, so AEDT starts the track at the origin and heads north. After all of the x,y points are calculated, the entire set of track points is rotated and translated such that the segment corresponding to the final (straight) vector command is parallel to the runway and ends at the displaced approach threshold point along the runway.

When processing a departure vector track, AEDT makes the first track point coincide with the displaced takeoff threshold point on the runway.

AEDT approximates circular-arc portions of ground tracks with one or more pairs of straight line segments<sup>23</sup>. First, the number of sub-arcs,  $n_{sub}$ , to be used to span the total turning angle  $\xi$  (radians) of the arc is computed:

$$n_{sub} = \text{int} \left( 1 + \frac{\xi}{40} \cdot \frac{180}{\pi} \right) \quad \text{Eq. 3-22}$$

where the function  $\text{int}(x)$  returns the integer part of  $x$ .

Next, the angular extent,  $\Delta\xi$  (radians), of each sub-arc is computed:

$$\Delta\xi = \frac{\xi}{n_{sub}} \quad \text{Eq. 3-23}$$

Each sub-arc is approximated by two straight line segments, bound by three surface coordinates. The first surface coordinate is at the start of the sub-arc, and the third point is at the end of the sub-arc. The second point is half-way along the angular extent of the sub-arc, with its distance from the center of the sub-arc,  $r_2$  (m), given by:

$$r_2 = r \cdot \left[ \cos\left(\frac{\Delta\xi}{2}\right) + \sqrt{\left(\frac{\Delta\xi}{2}\right)^2 - \sin^2\left(\frac{\Delta\xi}{2}\right)} \right] \quad \text{Eq. 3-24}$$

where

$r$       Radius of the arc (m).

This method ensures that a line segment replaces not more than 20° of turn angle. Also, the sum of the lengths of the line segments equals the distance along the arc so that the flying time along the line segments is the same as the time that would be flown along the circular arc.

### 3.5.3 Radius of Curvature

The turning radius of an aircraft's ground track is an important consideration in accounting for aircraft banking. For vector tracks, there is no need to calculate the turning radius, since the radius is explicitly defined for each turning portion, and implicitly infinite for each straight portion. For pointwise tracks, the turning radius must be approximated from surface coordinate data. This objective is met through a three-step process:

1. Track point coordinates are interpolated at a regular spacing.
2. Turning radius is calculated from the interpolated points.
3. Turning radius values are interpolated back to the original points.

In the first step, each track is interpolated at 0.5 nautical mile intervals with cubic splines. A cubic spline is analogous to stretching a flexible piece of plastic so that it contacts all the track points. The interpolated track is smooth and continuous in the first derivative, and continuous in the second derivative, which eliminates sharp corners in the flight track that would be impossible for an aircraft to follow. Curvature derivatives are undefined at the track endpoints, so the second derivatives are set to zero, which is called the "natural" endpoint condition.

The next step is to calculate turning radius at each point by considering three consecutive track points at a time. The turning radius is equal to the radius of a circle passing through the three points. The circle radius  $r$  (m) is calculated as follows:

$$r = \frac{a \cdot b \cdot c}{4 \cdot K} \quad \text{Eq. 3-25}$$

where

$a, b, c$       Distances between three consecutive points in the track (m); and  
 $K$               Area of a triangle formed by the points (m<sup>2</sup>).

The calculated radius is assigned to the middle point, and the process is repeated for each set of three consecutive track points. The first and last points have an undefined radius, so the radius at these points is set to infinity (as though the track were straight).



### 3.6 Doc 9911 - BADA 3 Analysis of Profile-Driven Flight Performance

A flight profile describes the movement of an aircraft in terms of aircraft state characteristics (e.g., altitude, speed, flap setting, and thrust) as a function of horizontal distance over the ground (and in some cases for helicopters, time). A flight profile does not contain information about the lateral path an aircraft follows over the ground. “Speed” can be either a calibrated or a true airspeed, depending on the context.

AEDT can compute flight performance for a profile-driven operation according to the Doc 9911 and BADA 3 models or the Doc 9911 and BADA 4 models, depending on user inputs. BADA 4 analysis of profile-driven flight performance is discussed in Section 3.7. When Doc 9911 analysis is used for profile-driven performance, AEDT calculates the profile as described in Section 3.6.2, with the weather model localized in the manner presented in Section 3.6.1.

#### 3.6.1 Local Weather

For each step calculated in a procedure, weather conditions are taken to have no lateral or temporal variation. That is, atmospheric profiles at the most recently calculated surface coordinate and time are assumed to remain constant throughout the step. The term *atmospheric profiles* refers to the variation of local weather with altitude.

#### 3.6.2 Airplane Profile Calculation

Airplane profiles describe how the state of an airplane changes as the flight progresses. When a flight profile is comprised of procedure steps, AEDT processes the steps one at a time to calculate profile points, ultimately expressing the steps in the same format as in Section 3.6.2.7. Otherwise, the profile is already expressed in this form directly as fixed points.

Sections 3.6.2.1 through 3.6.2.6 discuss aspects of the AEDT profile treatment that are independent of component type. Section 3.6.2.7 then details how each specific type of profile component is processed to determine segment end-point values of altitude, speed, noise thrust, and corrected net thrust.

##### 3.6.2.1 Temporal and Trackwise Alignment

Since the duration and horizontal length of some procedure steps may change with local weather variation, the length of a flight profile depends on the time and location (distance along the computed track) where the profile begins. Since airplane profiles are calculated in forward order with respect to horizontal distance, and flight time is calculated along the flight path from the speed and track data, the profiles’ initial time and trackwise distance are necessarily determined iteratively, as is the length of the “fit-to-track” segments in circuit and touch-and-go profiles. The first guess of initial trackwise distance is always zero (the beginning of the calculated ground track), while the first guess of initial time is set to whichever reference time is appropriate to the operation type (departure off-time for departures and circuits, arrival on-time otherwise). After the profile is calculated from these settings, improved guesses are formulated based on the amount by which the respective temporal and spatial targets were missed. This is repeated until the profile is aligned with its temporal and trackwise anchors. If alignment is not sufficiently achieved within 500 iterations, AEDT logs a message to the user indicating the amounts by which the anchors were missed for the flight.

The process of aligning a departure procedure in time and along the track is illustrated in Figure 3-9. Initial distance along the track is known to be zero, so no trackwise iteration is required. Initial time is iteratively adjusted until takeoff ground roll in the calculated profile ends at “departure off-time”.

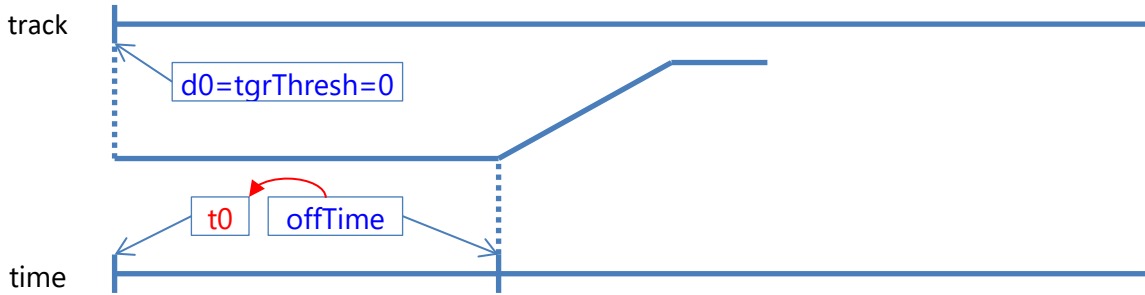

Figure 3-9 Track Alignment – Departure Procedure

The process of aligning an approach procedure in time and along the track is illustrated in Figure 3-10. Initial distance along the track is iteratively adjusted until the calculated profile reaches the threshold crossing height at the known track coordinate of the approach threshold. Initial time is iteratively adjusted until the landing ground roll in the calculated profile begins at “arrival on-time”.

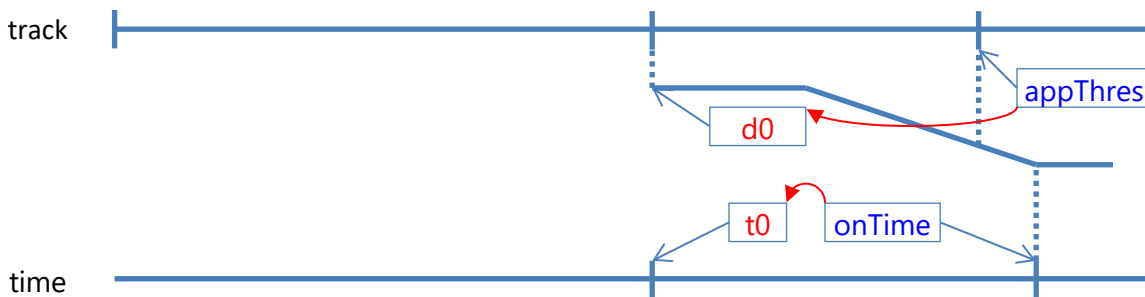

Figure 3-10 Track Alignment – Approach Procedure

The process of aligning an overflight procedure in time and along the track is illustrated in Figure 3-11. Initial distance along the track is known to be zero, so no trackwise iteration is required. Likewise, initial time is known to be “arrival on-time”, so no temporal iteration is required.

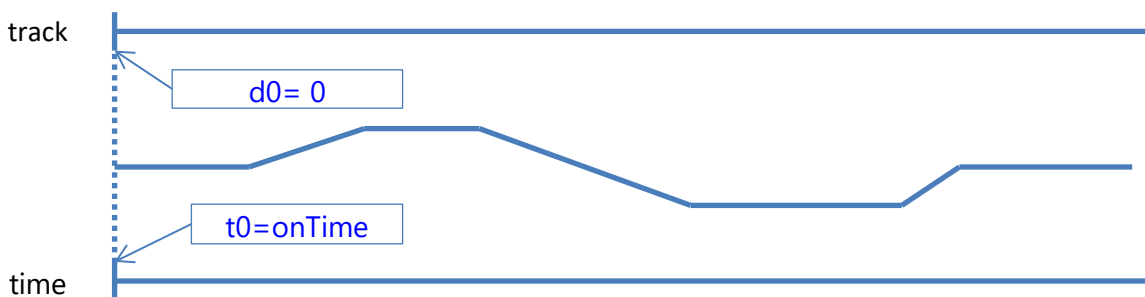

Figure 3-11 Track Alignment – Overflight Procedure

The process of aligning a touch-and-go procedure in time and along the track is illustrated in Figure 3-12. Initial distance along the track is iteratively adjusted until the calculated profile reaches the threshold crossing height at the known track coordinate of the approach threshold, which is zero or any multiple of the track length (since the track loops on itself). Initial time is iteratively adjusted until the landing ground roll in the calculated profile begins at “arrival on-time”. After the initial time and trackwise

distance have been resolved, the length of the “fit-to-track” step is iteratively adjusted until the end of that step in the computed profile is beyond the initial track coordinate by the track’s length.

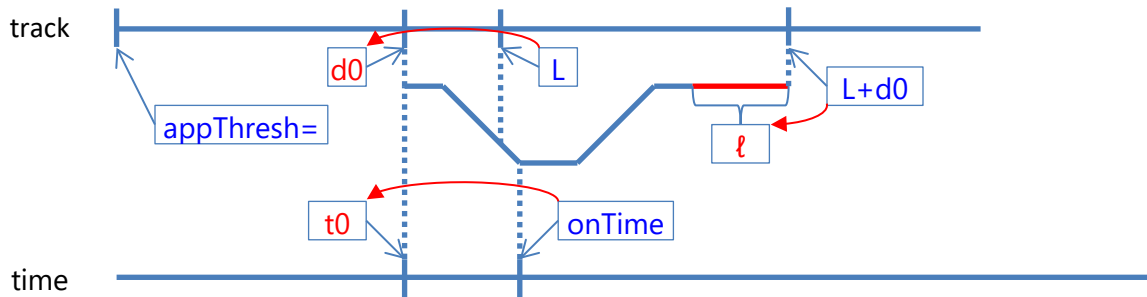

Figure 3-12 Track Alignment – TGO Procedure

The process of aligning a circuit procedure in time and along the track is illustrated in Figure 3-13. Initial distance along the track is known to be zero, so no trackwise iteration is required. Initial time is iteratively adjusted until takeoff ground roll in the calculated profile ends at “departure off-time”. After the initial time has been resolved, the length of the “fit-to-track” step is iteratively adjusted until the calculated profile reaches the threshold crossing height at the known track coordinate of the approach threshold, which is at the full track’s length from the beginning.

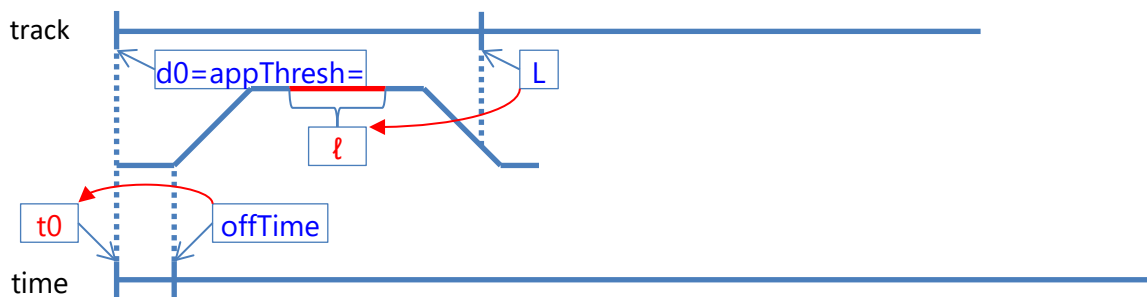

Figure 3-13 Track Alignment – Circuit Procedure

### 3.6.2.2 Doc 9911 Thrust Computations

Thrust figures prominently in the force balances used in Doc 9911 analysis of procedural flight profiles. It is also the primary basis for the determination of noise levels in AEDT. In some contexts, such as the Doc 9911 performance specification or normalized plots in engine performance literature, thrust is expressed as the corrected net thrust per engine, which is the net thrust scaled by the local atmospheric pressure ratio. For certain profile components, the thrust may be specified as an input. This may take the form of a specific value or a thrust rating. There are also circumstances in which thrust is unknown and therefore calculated through an equation that models flight mechanics, such as the minimum (engine-out) force balance. Specific value, thrust rating, and minimum engine-out thrust (based on force balance) are described below.

Noise thrust indicates the value of an airplane’s power setting (the ‘Power’ in the Noise-Power-Distance data sets). Each aircraft is associated with empirical datasets that model the aircraft’s noise as a function of its noise thrust. Noise thrust is defined as the net corrected thrust when appropriate performance data are available. When appropriate performance data are not available (i.e., net corrected thrust is

not directly calculated), the noise thrust can be defined as a percentage of the aircraft static thrust (where aircraft static thrust is in units of Newtons). If performance data or static thrust data are not available<sup>xii</sup>, noise thrust values can be taken from engine parameters and provided directly as inputs to the performance calculations; no physics-based performance modeling is done. The units of these inputs, described as “other”, are assumed to match the units used for the noise datasets.

### 3.6.2.2.1 Thrust Value

When thrust is provided as a specific value, the value indicates the magnitude of corrected net thrust per engine. For procedure steps, the given thrust is taken to apply throughout the entire step for the purpose of performance modeling. The specific value option is available for takeoff ground roll, constant-CAS climb, or accelerating climb steps, as well as for fixed profile points. It is also available as a percentage for braking ground roll.

### 3.6.2.2.2 Thrust Rating

When thrust is provided as a rating, the corrected net thrust per engine is calculated using a set of parameters from the ANP database<sup>13</sup>. Ratings indicate a standard power level for the aircraft, such as maximum takeoff, reduced climb, idle, etc. Each rating that is defined for an aircraft has its own set of thrust parameter values. The parameter sets and thrust calculations used for aircraft modeled as jets are substantially different from those used for aircraft modeled as propeller-driven. The thrust rating option is available for takeoff ground roll, constant-CAS climb, and accelerating climb steps.

#### 3.6.2.2.2.1 Jet Rated Thrust

AEDT calculates jet aircraft corrected net thrust per engine by using a modified version of SAE-AIR-1845<sup>3</sup> equation (A1):

$$\frac{F_n}{\delta} = E + F \cdot v + G_A \cdot h + G_B \cdot h^2 + H \cdot T_C \quad \text{Eq. 3-26}$$

where

$\frac{F_n}{\delta}$	Corrected net thrust per engine (lbf);
$v$	Equivalent/calibrated airspeed (kt);
$h$	Pressure altitude (ft) MSL;
$T_C$	Temperature (°C) at the aircraft; and
$E, F, G_A, G_B, H$	Regression coefficients that depend on power state (max-takeoff or max-climb power) and temperature state (below or above engine breakpoint temperature) (lbf, lbf/kt, lbf/ft, lbf/ft <sup>2</sup> , lbf/°C, respectively).

AEDT models a jet engine by using sets of coefficients that are tailored for specific profile steps, such as takeoff, climb or idle steps. Many aircraft have two sets of coefficients for max-takeoff power and two sets for max-climb power. For a given power state, AEDT models the effect of jet engine breakpoint temperature by using coefficients  $(E, F, G_A, G_B, H)_{\text{low}}$  for ambient temperatures below the breakpoint temperature and coefficients  $(E, F, G_A, G_B, H)_{\text{high}}$  above breakpoint. AEDT calculates both  $(F_n/\delta)_{\text{low}}$  and  $(F_n/\delta)_{\text{high}}$  and then uses the smaller of the two values as the corrected net thrust for a given power state.

xii Performance or static thrust data may be unavailable for some military and general aviation aircraft.

If the high-temperature coefficients do not exist in the database, AEDT calculates high-temperature corrected net thrust by the equation:

$$\left(\frac{F_n}{\delta}\right)_{high} = F_{low} \cdot v + (E_{low} + H_{low} \cdot T_{BC}) \frac{1 - 0.003 \cdot T_F}{1 - 0.003 \cdot T_{BF}} \quad \text{Eq. 3-27}$$

where

$\left(\frac{F_n}{\delta}\right)_{high}$	High-temperature corrected net thrust (lbf);
$E_{low}, F_{low}, H_{low}$	Regression coefficients for the low-temperature equation (lbf, lbf/kt, lbf/°C, respectively);
$v$	Calibrated airspeed (kt);
$T_F$	Temperature (°F) at the aircraft;
$T_{BC}$	Breakpoint temperature, $T_{BC} = 30^\circ\text{C}$ ; and
$T_{BF}$	Breakpoint temperature, $T_{BF} = 86^\circ\text{F}$ .

### 3.6.2.2.2 Propeller Rated Thrust

AEDT calculates propeller-driven aircraft corrected net thrust per engine by using SAE-AIR-1845<sup>3</sup> equation (A4):

$$\frac{F_n}{\delta} = \frac{\left(\frac{325.87 \cdot \eta \cdot P}{v_T}\right)}{\delta} \quad \text{Eq. 3-28}$$

where

325.87	Unit conversion: horsepower/kt to lbf;
$\eta$	Propeller efficiency, which depends on the power state (dimensionless);
$P$	Net power per engine (horsepower, MSL standard day), which depends on the power state (max-takeoff or max-climb);
$v_T$	True airspeed (kt); and
$\delta$	Pressure ratio at aircraft altitude (dimensionless).

### 3.6.2.2.3 Minimum Engine-Out

The only force-balance based thrust level that can be specified as an input to AEDT performance calculations is the minimum engine-out thrust. This thrust is calculated by:

$$\frac{F_n}{\delta} = \frac{\left(\frac{W}{\delta_2}\right) \cdot \left\{ \left[ \frac{\sin\left(\tan^{-1}\frac{G}{100}\right)}{K} \right] + R_f \right\}}{N - 1} \quad \text{Eq. 3-29}$$

where

$W$	Departure profile weight (lbf);
$\delta_2$	Pressure ratio at altitude $A_2$ (dimensionless);
$G$	Engine-out percentage climb gradient from FAR Part 25 <sup>26</sup> (dimensionless): $G = 0$ for aircraft with Automatic Thrust Restoration Systems; $G = 1.2$ for 2-engine aircraft; $G = 1.5$ for 3-engine aircraft; or

	G = 1.7 for 4-engine aircraft.
$K$	Speed-dependent constant (dimensionless): K = 1.01 when climb speed $\leq$ 200 KCAS; or K = 0.95 otherwise. This constant accounts for the effects on climb gradient of climbing into an 8-knot headwind and the acceleration inherent in climbing at constant calibrated airspeed (true speed increases as air density diminishes with height);
$R_f$	Drag-over-lift coefficient that depends on the flaps setting (dimensionless); and
$N$	Number of engines ( $N > 1$ ) (dimensionless).

This option is available for constant-CAS climb or accelerating climb. Note that this method will underpredict the actual thrust required, since the  $R_f$  value used is for a standard, all-engines operating flight condition – an engine out condition will have significantly more drag than an all-engines operating condition.

### 3.6.2.3 Data Development for Doc 9911 Reduced Thrust

#### 3.6.2.3.1 Introduction

Prior versions of the FAA's environmental models, including legacy models and previous versions of AEDT, provided the user with default standard departure procedures. To be adequately conservative, these default procedures included engine thrust settings corresponding to the maximum available takeoff and climb thrusts. However, studies<sup>xiii</sup> have shown that in practice, aircraft operators will use reduced thrust departure procedures where possible to reduce engine wear. The amount of thrust reduction applied is at the pilot's discretion and can be based on the methods of an assumed temperature or a balanced field length. Implementing these methods to calculate the exact amount of thrust reduction is currently outside of AEDT's scope; instead, a set of user selectable reduced thrust procedures is provided. These reduced thrust procedures are provided for most of the modern (noise stage 3 and higher) turbofan aircraft in the AEDT Fleet database. Turboprop and piston-engine airplanes are not affected, nor are helicopters.

#### 3.6.2.3.2 Development

AEDT provides the user with the option of 5%, 10%, or 15% reduced thrust departure profiles based on standard procedures. The traditional (standard, ICAOA and ICAOB) procedures using full rated thrust (i.e., no thrust reduction) are still available. In addition, the procedures associated with the reduced thrust method have been modified to use an energy share as opposed to fixed rates of climb during acceleration steps. These changes and the method of thrust modeling at high temperatures with reduced thrust are discussed below.

##### 3.6.2.3.2.1 Thrust Coefficient Changes

The reduced engine thrust is implemented via a straight-forward multiplication of the existing engine thrust coefficients by the complement of the thrust reduction percentage. The thrust coefficients  $C_{full}$

<sup>xiii</sup> Airport Cooperative Research Program, Estimating Takeoff Thrust Settings for Airport Emissions Inventories, <https://trid.trb.org/view.aspx?id=1349049>, April 4, 2015.

that need to be modified include the E, F, GA, GB, and H coefficients defined in Eq. 3-26. For the reasons explained in Section 3.6.2.3.2.3, only the flat-rated thrust coefficients are modified; the high temperature thrust coefficients are not modified. The reduced thrust coefficient set can be calculated using the equation below:

$$C_{RT} = k_{reduced} \cdot C_{Full} \quad \text{Eq. 3-30}$$

Where the reduction coefficient,  $k_{reduced}$  is specified as follows:

$$k_{reduced} = \begin{cases} 1.00 & \text{Full Thrust} \\ 0.95 & \text{5\% reduced thrust} \\ 0.90 & \text{10\% reduced thrust} \\ 0.85 & \text{15\% reduced thrust} \end{cases} \quad \text{Eq. 3-31}$$

During the development of the reduced thrust method, it was noted that, in practice, aircraft operators do not necessarily use the same thrust reduction for takeoff and climb power. Often, climb thrust reduction is less than the takeoff thrust reduction. For this reason, the climb thrust reduction is not selected directly by the user, but is a function of the takeoff thrust reduction which is selected by the user. The thrust reduction schedule is given below in Table 3-3.

Table 3-3 Thrust Reduction Schedule

Procedure Thrust Reduction	Takeoff Thrust Reduction	Climb Thrust Reduction
0% (standard default procedures)	0%	0%
5%	5%	0%
10%	10%	10%
15%	15%	10%

In addition, new thrust types are created for each reduced thrust reduction setting in order for AEDT to work with them. Table 3-4 lists the new thrust types for flat-rated and high temperature conditions. The high temperature reduced thrust types (A, E, W, and Y) replicate the unmodified, original high temperature data.

Table 3-4 Thrust Types for Reduced Thrust Setting

Thrust Type	Description
A	MaxClimbReduce10HiTemp
D	MaxClimbReduce10
E	MaxTakeoffReduce05HiTemp
F	MaxTakeoffReduce05
W	MaxTakeoffReduce10HiTemp
X	MaxTakeoffReduce10
Y	MaxTakeoffReduce15HiTemp

Thrust Type	Description
Z	MaxTakeoffReduce15

### 3.6.2.3.2.2 Procedure Changes

In addition to the changes to the thrust coefficients, the procedural profiles for the associated aircraft also needed to be changed. In general, the procedures provided by the aircraft manufacturers include steps where the aircraft is climbing while accelerating (Section 3.6.2.7.4). The climb rate during these acceleration steps is usually a fixed number – this is the climb rate for the aircraft at the given procedure weight at sea level ISA conditions at the given thrust. If the aircraft is using reduced thrust, the original, non-reduced thrust climb rate is no longer correct. For this reason, the reduced thrust procedures acceleration steps have been changed from using fixed climb rates to using an energy share method (Section 3.6.2.7.5), which require the use of procedural profiles<sup>xiv</sup>. During the development of the reduced thrust methods, the existing acceleration steps were used to find the appropriate energy share parameter which would provide the same sea level, ISA climb rates.

### 3.6.2.3.2.3 High Temperature

The reduced thrust methods are only applied to the flat-rated part of the engine thrust; the high temperature coefficients are not modified. The lower of the reduced thrust and the high temperature thrust is used as the resulting thrust, as discussed in Section 3.6.2.2.1.

An example of the relationship between the flat-rated, reduced, and high temperature engine thrusts is given in Figure 3-14 below. This example engine has a break point temperature of 28C. At temperatures below 50C, the engine is still capable of operating at thrusts greater than the 15% reduced level used in this example, so the reduced thrust rating is still used. Above 50C, the engine is no longer capable of generating 85% (15% reduced thrust) of the rated takeoff power; the high temperature curve is used to represent the available power of the engine above 50C.

<sup>xiv</sup> Aircraft with only fixed point profiles cannot be modeled using reduced thrust and alternative weights at this time.



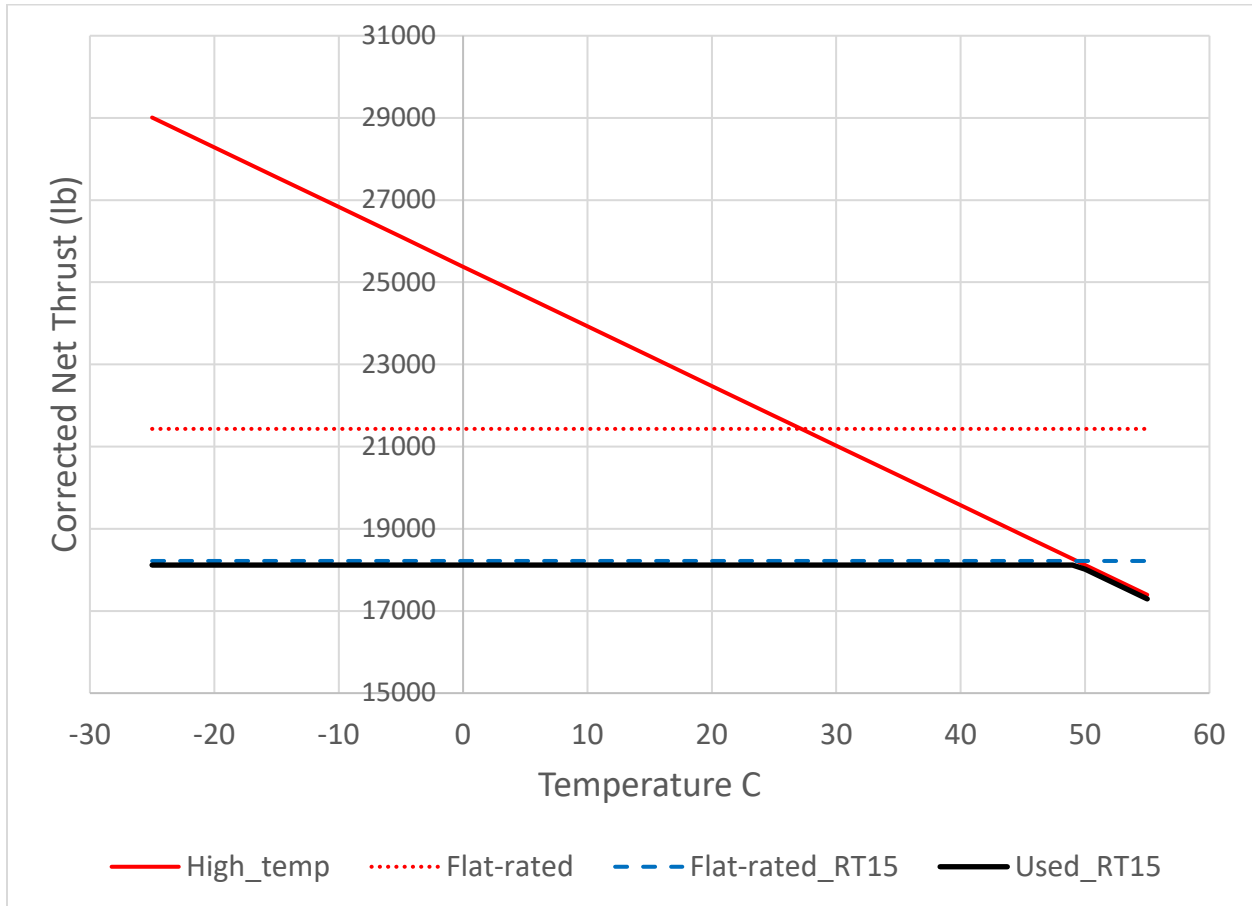

Figure 3-14 Thrust Rating Comparison – Takeoff Thrust, 15% Reduced Thrust

**3.6.2.4 Data Development for Alternative-Weight Profiles**

AEDT also includes alternative weight profiles, in addition to the traditional aircraft profiles (standard, ICAOA and ICAOB). Alternative weight procedures use a heavier weight than the corresponding STANDARD and MODIFIED\_RT procedures in the same stage length bins. At each stage length, the higher weight option is determined by taking the average of the current stage length weight and the weight of the next-highest stage length.

For the highest stage length procedure, alternative weight procedures use the current stage length weight. As such, STANDARD and MODIFIED\_AW procedures for the maximum stage length have the same weight and thrust specifications.

The profile naming conventions for all AEDT profiles are described in Table 3-5.

Table 3-5 Profile Naming Convention

Profile Type	Profile Naming Convention	Comments
<b>Default Profiles</b>		
STANDARD	STANDARD	Departure, Approach, Circuit or Touch and Go operations
NOISEMAP	NOISEMAP	Departure, Approach Military Aircraft Profiles
ICAOA	ICAO A, ICAO_A, ICAOA, ICAO-A	Departure operations only
ICAOB	ICAO B, ICAO_B, ICAOB, ICAO-B	Departure operations only
CNA206/CNA20T Specific	3000LB, 3300LB, 3600LB	Departure operations only
CNA510/CNA55B Specific	FLAPS_0, FLAPS_15	Departure operations only
CNA750 Specific	FLAP_5, FLAP_15	Departure and Approach operations
ECLIPSE500 Specific	HI_ALT	Departure operations only
GII/GIIB Specific	QF_FLEX, QF_FULL	Departure operations only
<b>Non-Default Profiles*</b>		
Alternative Weight	MODIFIED_AW	Departure operations only
Reduced Thrust	MODIFIED_ + percent reduced thrust (e.g., "MODIFIED_RT05")	Departure operations only. Typical reduced thrust values are 5%, 10% and 15%
Alternative Weight and Reduced Thrust	MODIFIED_AW_ + percent reduced thrust (e.g., "MODIFIED_AW_RT15")	Departure operations only. Typical reduced thrust values are 5%, 10% and 15%

\* Refer to Appendix J in the AEDT 3g User Manual<sup>1</sup> for further information on appropriate justification for use of Non-Default Profiles.

### 3.6.2.5 True Airspeed

Procedural profiles specify speed in the form of calibrated airspeed (KCAS). True airspeed (KTAS) is also relevant to the flight mechanics modeled by AEDT. Calibrated airspeed is assumed to equal equivalent airspeed in the ICAO Doc 9911<sup>67</sup> performance specification. For Doc 9911 analysis, true airspeed for the explicitly-defined portion of a profile-driven operation is therefore calculated by using equation (A5), specified in SAE-AIR-1845<sup>3</sup> (which is equivalent to equation C-6 in ICAO Doc 9911<sup>67</sup>):

$$v_T = v / \sqrt{\sigma} \quad \text{Eq. 3-32}$$

where

- $v_T$  True airspeed (kt);
- $v$  Calibrated airspeed (kt); and
- $\sigma$  Air density ratio at aircraft altitude (dimensionless).

### 3.6.2.6 Displaced Thresholds and Threshold Crossing Heights

A departure flight path starts at a given distance from the departure end of the runway:

$$D = D_{dep} + \Delta_{trk} \quad \text{Eq. 3-33}$$

where

$D$	Start-roll distance (ft) from the end of the runway;
$D_{dep}$	Displaced departure threshold (ft) for the runway (user input); and
$\Delta_{trk}$	Delta distance (ft) for the departure ground track (user input).

An approach flight touches down on the runway at a given distance from the approach end of the runway:

$$D = D_{app} + \Delta_{trk} + \frac{h_{tc} \cdot |d_{-1}|}{z_{-1}} \quad \text{Eq. 3-34}$$

where

$D_{app}$	Displaced approach threshold (ft) for the runway (user input);
$h_{tc}$	Threshold crossing height (ft) for the runway (user input);
$d_{-1}$	Coordinate value (ft) of the profile point immediately before the touch-down point (it is a negative number); and
$z_{-1}$	Altitude AFE (ft) of the profile point immediately before the touch-down point (the touch-down point has coordinates: $d_0 = 0, z_0 = 0$ ).

### 3.6.2.7 Profile Components

The following sections describe how AEDT processes specific profile component types for Doc 9911 analysis. In general, one procedure step produces one profile point, but there are several exceptions. For example, a takeoff step produces two points (start-roll and takeoff rotation). Also, when there is a change in thrust setting (for example, going from max-takeoff to max-climb), an extra profile point is created so that thrust changes continuously over a small distance (1,000 ft), rather than discontinuously at a point.

Sometimes, data from one procedure step are combined with data from an adjacent step before a profile point can be computed. For example, two consecutive descent steps will specify their initial AFE altitude, KCAS, and angle of descent. AEDT uses the second descent step's initial altitude as the final altitude for the first step. These algorithmic details are not described. Instead, the production of profile points is presented in terms of "initial" and "final" points that define a profile segment.

For detailed information about the format and content of inputs required for the creation of user-defined profiles, see the AEDT Standard Input File Reference Manual<sup>24</sup>.

#### 3.6.2.7.1 Fixed Point

A fixed profile point specifies much of the aircraft's state at a particular horizontal coordinate and time. AFE Altitude (feet), distance, true airspeed (KTAS), and noise thrust require no calculation, as they are given directly. AEDT does not adjust noise thrusts for non-standard temperature and pressure (that is, the input values of noise thrust are directly used in the noise tables, regardless of its units). If the noise thrust is specified as a percent, the corrected net thrust is calculated by applying the given percentage

to the airplane's static thrust value. No corrected net thrust calculation is required when the noise thrust is specified in pounds (in which case the setting directly specifies the corrected net thrust) or any other units not mentioned here (in which case no relationship between noise thrust and actual engine thrust is specified).

### 3.6.2.7.2 Takeoff Ground Roll Step

A takeoff ground roll step models airplane acceleration on the ground before becoming airborne. For this type of step, the initial and final values of aircraft AFE altitude (feet) are given (the elevation of the starting runway end), the initial and final values of speed and thrust are calculated, and the horizontal distance is calculated.

For jets, the corrected net thrust per engine  $(F_n/\delta)_1$  at the start-roll point is calculated by using the departure thrust equation with  $v_1 = 0$  kts. For props, the corrected net thrust per engine  $(F_n/\delta)_1$  at the start-roll point is set equal to the corrected net thrust per engine  $(F_n/\delta)_2$  at the end of the step.

For jets and props, the corrected net thrust per engine  $(F_n/\delta)_2$  at the end of the step is calculated by using rated thrust as described in Section 3.6.2.2.2. The calibrated airspeed (KCAS) at the end of the step, which is used in the thrust equation, is modeled as the initial climb calibrated airspeed, and is calculated by using SAE-AIR-1845<sup>3</sup> equation (A7):

$$v_2 = C_f \cdot \sqrt{W} \quad \text{Eq. 3-35}$$

where

$v_2$	Initial climb calibrated airspeed (kt);
$C_f$	Takeoff speed coefficient that depends on flaps setting (kt/ $\sqrt{\text{lbf}}$ ); and
$W$	Departure profile weight (lbf); weight is assumed to remain constant for the entire departure profile.

For jets or props,  $(F_n/\delta)_1$  can be a user-input value. If so, then  $(F_n/\delta)_2$  is also set to equal the input value.

Takeoff ground-roll distance is calculated by using SAE-AIR-1845<sup>3</sup> equation (A6):

$$S_g = \frac{B_f \cdot \theta \cdot \left(\frac{W}{\delta}\right)^2}{N \cdot \left(\frac{F_n}{\delta}\right)_2} \quad \text{Eq. 3-36}$$

where

$S_g$	Ground-roll distance (ft);
$B_f$	Ground-roll coefficient, which depends on the flaps setting (ft/lbf);
$\theta$	Temperature ratio at the airport elevation (dimensionless);
$\delta$	Pressure ratio at the airport (dimensionless); and
$\left(\frac{F_n}{\delta}\right)_2$	Corrected net thrust per engine (lbf) at the end of takeoff step.

The takeoff ground-roll distance is corrected for headwind, by using SAE-AIR-1845<sup>3</sup> equation (A16):

$$S_{gw} = \frac{S_g \cdot (v_2 - w)^2}{(v_2 - 8)^2} \quad \text{Eq. 3-37}$$

where

$S_{gw}$	Ground-roll distance (ft) corrected for headwind;
$v_2$	Initial climb calibrated speed (kt); and
$w$	Headwind (kt).

The takeoff ground-roll distance is also corrected for runway gradient by using the equations:

$$S_{gc} = \frac{S_{gw} \cdot a}{a - 32.17 \cdot G} \quad \text{Eq. 3-38}$$

$$a = \frac{(v_2/\sqrt{\sigma})^2}{2 \cdot S_{gw}} \quad \text{Eq. 3-39}$$

$$G = \frac{E_2 - E_1}{L} \quad \text{Eq. 3-40}$$

where

$S_{gc}$	Ground-roll distance (ft) corrected for headwind and runway gradient;
$S_{gw}$	Ground-roll distance (ft) corrected for headwind;
$a$	Average acceleration (ft/s <sup>2</sup> ) along the runway;
$G$	Runway gradient; G is positive when taking-off uphill (dimensionless);
$E_1, E_2$	Runway end elevations (ft) MSL; and
$L$	Runway length (ft).

In AEDT, the corrected ground-roll distance  $S_{gc}$  is divided into sub-segments with variable lengths, with each segment covering an aircraft speed change of 20 kts. The number of sub-segments  $N_{segs}$  for the ground roll is calculated as:

$$N_{segs} = \text{int}\left(1 + \frac{v_{G_2}}{20}\right) \quad \text{Eq. 3-41}$$

where

$N_{segs}$	Number of sub-segments (dimensionless); and
$\text{int}(x)$	Function that returns the integer part of x.
$v_{G_2}$	Final groundspeed of the ground roll segment.

Acceleration is assumed to be constant, and each segment is calculated to cover an equal time period. The time,  $t$ , on each segment is calculated as:

$$t = \frac{2 \cdot S_{gc}}{v_{G_2} \cdot N_{segs}} \quad \text{Eq. 3-42}$$

where

$t$  Time (s) spent on each sub-segment.

The distance, speed, and thrust values at the  $N_{\text{segs}}$  segment end points are calculated by linear interpolation on time.

### 3.6.2.7.3 Constant-CAS Climb Step

A constant-CAS climb segment models the climb of an aircraft at constant calibrated airspeed to a target AFE altitude (feet). For this type of step, the initial and final altitudes are given ( $A_1$  is from the previous segment and  $A_2$  is user input), the initial and final speeds are calculated using the final calibrated airspeed (KCAS) on the previous segment, the initial thrust  $(F_n/\delta)_1$  is given from the previous segment, the final thrust is calculated, and the horizontal distance is calculated.

A climb segment is flown at constant calibrated airspeed,  $v$ , climbing from altitude  $A_1$  to altitude  $A_2$ . Even though a climb segment uses constant calibrated airspeed, the true airspeeds  $v_{T1}$  and  $v_{T2}$  (KTAS) at the segment end points are different because the air densities  $\sigma_1$  and  $\sigma_2$  are different. The speeds are calculated according to Eq. 3-32 from their corresponding density ratios.

The nominal corrected net thrust per engine,  $F_n/\delta$ , and the final corrected net thrust per engine,  $(F_n/\delta)_2$ , are calculated differently depending on the thrust specification supplied for the procedure step:

1. When a thrust rating is specified, the nominal corrected net thrust per engine is calculated by using the rated thrust equations presented in Section 3.6.2.2.2 at the mid-point altitude  $A_m = \frac{1}{2}(A_1 + A_2)$ . Likewise, a nominal value of the pressure ratio,  $\delta$ , is sampled at the mid-point altitude  $A_m$ . The final corrected net thrust per engine is calculated from the same equations, at calibrated airspeed  $v$  and the final altitude  $A_2$ .
2. When thrust is specified directly by value without a cutback segment, the nominal value of corrected net thrust per engine is set to the specified value,  $F_n/\delta = \text{user-input thrust}$ . The nominal value of the pressure ratio,  $\delta$ , is calculated at the mid-point MSL altitude.

The calculated initial corrected net thrust per engine  $(F_n/\delta)_1$  is retained, and the final corrected net thrust per engine is also set to the specified thrust.

3. When a thrust is specified directly by value with a cutback segment, the nominal value of corrected net thrust per engine is set to the specified value,  $F_n/\delta = \text{user-cutback thrust}$ . The nominal value of the pressure ratio,  $\delta$ , is calculated at the mid-point MSL altitude.

The climb segment is calculated and then separated into two sub-segments, both having the same climb angle. The first sub-segment is assigned a 1,000 ft ground distance and the corrected net thrust per engine at the end of 1,000 ft is set equal to the user-cutback thrust value. If the original horizontal distance is less than 2,000 ft, one half of the segment is used to cutback thrust. The final thrust on the second sub-segment is also set equal to the user-cutback thrust. Thus, the second sub-segment is flown at constant thrust.

Another 1,000 ft sub-segment restores the thrust from the user-cutback value to the calculated value  $(F_n/\delta)_2$  at altitude  $A_2$ . This sub-segment is created in the next climb or acceleration segment.

- When engine-out minimum thrust is specified, the nominal value of corrected net thrust per engine  $F_n/\delta$  is calculated by using the minimum engine-out procedure described in Section 3.6.2.2.3. The nominal value of the pressure ratio  $\delta$  is set to the final value calculated at MSL altitude  $A_2$ .

Two 1,000 ft sub-segments are introduced in a manner similar to the user-cutback case.

The average climb angle is calculated by using SAE-AIR-1845<sup>3</sup> equation (A8):

$$\gamma = \sin^{-1} \left( K \cdot \left[ \frac{N \cdot \left( \frac{F_n}{\delta} \right)}{\left( \frac{W}{\delta} \right)} - R_f \right] \right) \quad \text{Eq. 3-43}$$

where

$\gamma$	Average climb angle (radians)
$K$	Speed-dependent constant (dimensionless); K=1.01 when climb speed $\leq$ 200 KCAS; or K=0.95 otherwise;
$N$	Number of engines (dimensionless);
$\left( \frac{F_n}{\delta} \right)$	Nominal value of corrected net thrust per engine (lbf);
$\delta$	Nominal value of the pressure ratio (dimensionless);
$W$	Departure profile weight (lbf); and
$R_f$	Drag-over-lift coefficient that depends on the flaps setting (dimensionless).

The above method of setting the constant K is slightly different than specified in SAE-AIR-1845<sup>3</sup>, where the initial climb segment uses K=1.01, and climb segments after acceleration and flaps-retraction use K=0.95. The AEDT method is designed to handle flight profiles where the order of climb and acceleration segments is mixed.

The climb angle is corrected for headwind by using SAE-AIR-1845<sup>3</sup> equation (A17):

$$\gamma_w = \frac{\gamma \cdot (v - 8)}{(v - w)} \quad \text{Eq. 3-44}$$

where

$\gamma_w$	Average climb angle corrected for headwind;
$\gamma$	Average climb angle (uncorrected);
$v$	Calibrated airspeed (kt) on the climb segment; and
$w$	Headwind (kt).

Finally, the horizontal distance for the climb segment is calculated by using SAE-AIR-1845<sup>3</sup> equation (A9):

$$S_c = \frac{A_2 - A_1}{\tan \gamma_w} \quad \text{Eq. 3-45}$$

where

$S_c$  Horizontal distance (ft) for the climb segment;  
 $A_1$  Initial altitude (ft) MSL; and  
 $A_2$  Final altitude (ft) MSL.

#### 3.6.2.7.4 Accelerating Climb Step by Climb Rate

An accelerating climb step models acceleration to a target calibrated airspeed (KCAS) at a specified rate of climb. For this type of step, the initial AFE altitude  $A_1$ , initial true airspeed  $v_{T1}$  (KTAS), and initial thrust  $(F_n/\delta)_1$  are given from the previous segment. The final calibrated airspeed  $v_2$  (KCAS) and the average climb rate  $v_{Tz}$  are user inputs. The final altitude, final true airspeed, final thrust, and horizontal flying distance are calculated.

Altitude, speed, thrust, and distance are calculated by using an iterative method. The final MSL altitude  $A_2 = A_1 + 250$  ft is used for the first iteration, and then  $A_2$  is recalculated until the absolute difference between the current and next iteration  $A_2$  values is less than one ft.

The horizontal distance is calculated by using SAE-AIR-1845<sup>3</sup> equation (A10):

$$S_a = \frac{0.95 \cdot k \cdot (v_{T2}^2 - v_{T1}^2)}{G_m - G} \quad \text{Eq. 3-46}$$

where

$S_a$  Current iteration horizontal distance (ft);  
 $k$  Constant:

$$k = \frac{1}{2} \cdot \left( \frac{101.2686}{60} \right)^2 \frac{1}{32.17} = 0.0442758 \text{ (feet/knots}^2\text{)}$$

$v_{T1}$  Input initial true airspeed (kt);  
 $v_{T2}$  Final true airspeed (kt) at current iteration  $\sigma_2$ :

$$v_{T2} = v_2 / \sqrt{\sigma_2}$$

where

$v_2$  Input final calibrated airspeed (kt);  
 $\sigma_2$  Air density ratio at current iteration final MSL altitude  $A_2$  (dimensionless);  
 $G_m$  Maximum acceleration available, as a fraction of g, for current iteration:

$$G_m = \frac{N \cdot \left( \frac{F_n}{\delta} \right)}{\left( \frac{W}{\delta} \right)} - R_f$$

where



$(F_n/\delta)$  Average corrected net thrust per engine (lb) at the current iteration:

$$\left(\frac{F_n}{\delta}\right) = \frac{1}{2} \left[ \left(\frac{F_n}{\delta}\right)_1 + \left(\frac{F_n}{\delta}\right)_2 \right]$$

where

$(F_n/\delta)_1$  Input initial corrected net thrust per engine (lbf);  
 $(F_n/\delta)_2$  Final corrected net thrust per engine (lbf) at current iteration altitude  $A_2$ ;  
 $\delta$  Pressure ratio at current iteration mid-point MSL altitude,  $(A_1 + A_2)/2$  (dimensionless);  
 $G$  Climb gradient for the current iteration value of  $v_{T2}$  (dimensionless):

$$G = \frac{v_{Tz}}{101.2686 \cdot \frac{1}{2} (v_{T1} + v_{T2})}$$

where

$v_{Tz}$  Input climb rate (ft/min).

The next-iteration final altitude  $A'_2$  (ft) is calculated by using SAE-AIR-1845<sup>3</sup> equation (A11):

$$A'_2 = A_1 + \frac{S_a \cdot G}{0.95} \quad \text{Eq. 3-47}$$

When  $A'_2 - A_2 < 1$ ft, the current iteration values of final altitude  $A_2$ , final true airspeed  $v_{T2}$ , final corrected net thrust per engine  $(F_n/\delta)_2$ , and horizontal distance  $S_a$  are used for the acceleration segment.

If during the iteration process  $(G_m - G) < 0.02$ , the acceleration is considered to be too small to achieve the desired  $v_2$  in a reasonable distance. AEDT then limits the climb gradient to  $G = G_m - 0.02$ . In effect, the desired climb rate is reduced so that the airplane can maintain a minimum acceleration. If  $G < \sin(0.5^\circ)$ , AEDT issues an error message and stops computing the profile, as there is not enough thrust to both accelerate and climb, as required by the segment parameters. Note that the criterion  $G < \sin(0.5^\circ)$  is an approximation of the criterion  $G < 0.01$  specified by Doc 9911, as  $\sin(0.5^\circ) \approx 0.0087$ .

The acceleration segment distance is corrected for headwind by using SAE-AIR-1845<sup>3</sup> equation (A18):

$$S_{aw} = \frac{S_a \cdot (v_T - w)}{(v_T - 8)} \quad \text{Eq. 3-48}$$

where

$S_{aw}$  Horizontal distance (ft) corrected for headwind;  
 $S_a$  Horizontal distance (ft) for the acceleration segment, uncorrected; and  
 $v_T$  Average true airspeed (kts) on the segment:

$$v_T = (v_{T1} + v_{T2})/2$$

### 3.6.2.7.5 Accelerating Climb Step by Energy Share

An accelerating climb step by energy share models acceleration to a target calibrated airspeed (KCAS) with the rate of climb specified indirectly as a percentage of available acceleration. For this type of step, the initial AFE altitude  $A_1$ , initial true airspeed  $v_{T1}$  (KTAS), and initial thrust  $(F_n/\delta)_1$  are given from the previous segment. The final calibrated airspeed  $v_2$  (KCAS) and the energy-share percentage value  $A_p$  are user inputs. The final altitude, final true airspeed, final thrust, and horizontal flying distance are calculated.

Acceleration percent (accel-percent) segments are calculated in a similar manner as acceleration segments (see Section 3.6.2.7.4 above). The key difference is that accel-percent segments utilize an input energy-share percentage value while acceleration segments use an input average climb rate. The energy-share percentage value defines the division of aircraft thrust between uses for climbing vs. accelerating. The climb gradient,  $G$ , in Eq. 3-46 is replaced with a climb gradient calculated using the input acceleration percent value ( $A_p$ ). At an acceleration percent value of 100%, all thrust is dedicated to increasing airspeed and the climb rate will be zero. As  $A_p$  is decreased to 0%, more thrust is dedicated to climbing and less to acceleration. Acceleration for climbing is calculated as follows:

$$G = G_m \cdot (1 - A_p / 100) \quad \text{Eq. 3-49}$$

where

- $G$  Acceleration available for climbing as a fraction of  $g$  also called the climb gradient (dimensionless);
- $G_m$  Maximum available acceleration as a fraction of  $g$ , see Equation 2-35 (dimensionless); and
- $A_p$  Percentage of thrust applied to acceleration.

Thus, Eq. 3-49 is used instead to calculate  $G$  in Eq. 3-46, and the process is otherwise identical to the acceleration segment. Note that the limits on  $G_m - G$  discussed in Section 3.6.2.7.4 will come into play when the value of  $A_p$  is very small, but in the case of this step type, there is an additional trigger for enforcement: if during the iteration process  $G < \sin(0.5^\circ)$ , AEDT limits the climb gradient to  $G = \sin(0.5^\circ)$ , and then if  $(G_m - G) < 0.02$ , AEDT issues an error message and stops computing the profile.

### 3.6.2.7.6 Cruise-Climb Step

A cruise-climb step models a climb at a specific angle to a target altitude and calibrated airspeed (KCAS). For this type of step, the initial AFE altitude, true airspeed (KTAS), and thrust are given from the previous segment. The final altitude  $A_2$ , final calibrated airspeed  $v_2$  (KCAS), and climb angle  $\gamma$  are user inputs (the initial and final calibrated airspeeds must be the same). The final true airspeed, final thrust, and horizontal distance are calculated. Cruise-climb thrust is less than "maximum-takeoff" or "maximum-climb" departure thrust.

The final corrected net thrust per engine is calculated by using SAE-AIR-1845<sup>3</sup> equation (A15) with an additive term for climb thrust:

$$\left(\frac{F_n}{\delta}\right)_2 = \frac{\left(\frac{W}{\delta_2}\right) \cdot \left(R_f + \frac{\sin \gamma}{0.95}\right)}{N} \quad \text{Eq. 3-50}$$

where

$\left(\frac{F_n}{\delta}\right)_2$	Corrected net thrust per engine (lbf) at altitude $A_2$ ;
$W$	Profile weight (lbf);
$\delta_2$	Pressure ratio at altitude $A_2$ (dimensionless);
$R_f$	Drag-over-lift coefficient that depends on flaps and gear setting (dimensionless);
$\gamma$	Average climb angle (a positive value); and
$N$	Number of engines (dimensionless).

The horizontal distance is calculated by:

$$S_{cc} = \frac{A_2 - A_1}{\tan \gamma} \quad \text{Eq. 3-51}$$

where

$S_{cc}$	Horizontal distance (ft) for the cruise-climb segment;
$A_1$	Initial altitude (ft) MSL; and
$A_2$	Final altitude (ft) MSL ( $A_1 < A_2$ ).

### 3.6.2.7.7 Descent Step

A descent step models descent at a specific angle to a target altitude and calibrated airspeed (KCAS), neglecting deceleration effects. For this type of step, the initial AFE altitude, true airspeed (KTAS), and thrust are given from the previous segment. The final altitude  $A_2$ , final calibrated airspeed  $v_2$  (KCAS), and descent angle  $\gamma$  are user inputs, with the final altitude and final calibrated airspeed being input on the following segment. The final true airspeed, final thrust, and horizontal distance are calculated.

The final true airspeed  $v_{T_2}$  (kt) is:

$$v_{T_2} = v_2 / \sqrt{\sigma_2} \quad \text{Eq. 3-52}$$

where

$v_2$	Input final calibrated airspeed (kt); and
$\sigma_2$	Density ratio at MSL altitude $A_2$ (dimensionless).

The final corrected net thrust per engine is calculated by using by using SAE-AIR-1845<sup>3</sup> equation (A15):

$$\left(\frac{F_n}{\delta}\right)_2 = \frac{\left(\frac{W}{\delta_2}\right) \cdot \left(R_f - \frac{\sin \gamma}{1.03}\right)}{N} \quad \text{Eq. 3-53}$$

where

$\left(\frac{F_n}{\delta}\right)_2$	Corrected net thrust per engine (lbf) at MSL altitude $A_2$ ; and
$\gamma$	Average descent angle (a positive value).

The final corrected net thrust per engine is corrected for headwind by using SAE-AIR-1845<sup>3</sup> equation (A19):

$$\left(\frac{F_n}{\delta}\right)_{2w} = \left(\frac{F_n}{\delta}\right)_2 + \frac{1.03 \cdot \left(\frac{W}{\delta_2}\right) \cdot \sin \gamma \cdot (w - 8)}{N \cdot v_2} \quad \text{Eq. 3-54}$$

where

$\left(\frac{F_n}{\delta}\right)_{2w}$  Corrected net thrust per engine (lbf) for headwind  $w$ ;  
 $w$  Headwind (kt); and  
 $v_2$  Calibrated airspeed (kt) at MSL altitude  $A_2$ .

The horizontal distance is calculated by:

$$S_d = \frac{A_1 - A_2}{\tan \gamma} \quad \text{Eq. 3-55}$$

where

$S_d$  Horizontal distance (ft) for the descent segment;

### 3.6.2.7.8 Deceleration-Sensitive Descend Step

A deceleration-sensitive descend step models descent at a specific angle to a target AFE altitude and calibrated airspeed (KCAS), adjusting one of the targets to preserve the deceleration that would have been observed in an ISA. For this type of step, the initial altitude, true airspeed, and thrust are given from the previous segment. The final AFE altitude  $A_2$ , final calibrated airspeed  $v_2$  (KCAS), and descent angle  $\gamma$  are user inputs, with the final AFE altitude and final calibrated airspeed being input on the following segment. The final true airspeed, final thrust, and horizontal distance are calculated. Although the inputs for this type of step are the same as for a standard descent step, this type of step (as well as the “Descend-Idle” step described in Section 3.6.2.7.9) is calculated in a way that preserves the acceleration value implied by its inputs.

In AEDT, the initial AFE altitude and KCAS appear to be user-defined; however, a descend-decel segment is not actually calculated until the next segment is processed. This procedure is necessary so that an approach profile can start with a descend-decel segment.

The process for calculating Descend-Decel segments in AEDT is similar but not identical to the process described in Section B-10 of ECAC Doc 29<sup>70</sup>. AEDT assumes that the procedural profile using the descend-decel segment was defined for ISA reference conditions at a sea-level airport. The deceleration that results over the segment given sea-level ISA conditions is assumed to remain constant even under non-sea level, non-ISA conditions, and other segment parameters are therefore modified for consistency under these conditions. Deceleration over the descend-decel segment for ISA conditions is calculated as:

$$a_{ISA} = \frac{\left(\sqrt{v_{T_2,ISA}^2 - w^2 \cdot \sin^2 \gamma} - w \cdot \cos \gamma\right)^2 - \left(\sqrt{v_{T_1,ISA}^2 - w^2 \cdot \sin^2 \gamma} - w \cdot \cos \gamma\right)^2}{2 \cdot S_d} \quad \text{Eq. 3-56}$$

where

$a_{ISA}$  Acceleration for ISA conditions (ft/s<sup>2</sup>);  
 $v_{T_{1ISA}}$  Initial true airspeed (ft/s) for ISA conditions  $\sigma_{1ISA}$ :

$$v_{T_{1ISA}} = \left( \frac{101.2686}{60} \right) v_1 / \sqrt{\sigma_{1ISA}}$$

where

$v_1$  Input initial calibrated airspeed (kt);  
 $\sigma_{1ISA}$  Air density ratio at initial MSL altitude  $A_1$  (for ISA conditions);  
 $\left( \frac{101.2686}{60} \right)$  Conversion from knots to feet per second (ft/s); and  
 $v_{T_{2ISA}}$  Final true airspeed (ft/s) for ISA conditions  $\sigma_{2ISA}$ :

$$v_{T_{2ISA}} = \left( \frac{101.2686}{60} \right) v_2 / \sqrt{\sigma_{2ISA}}$$

where

$v_2$  Input final calibrated airspeed (kt);  
 $\sigma_{2ISA}$  Air density ratio at final MSL altitude  $A_2$  (for ISA conditions);  
 $w$  Headwind (ft/s);  
 $\gamma$  Average descent angle (a positive value);  
 $S_d$  Length (ft) of the descent segment under ISA conditions:

$$S_d = \frac{A_1 - A_2}{\sin \gamma}$$

where

$A_1$  Initial altitude (ft) MSL; and  
 $A_2$  Final altitude (ft) MSL ( $A_1 > A_2$ ).

For non-ISA conditions, the segment's ISA deceleration and the input descent angle are held constant and either the final true airspeed or the segment length (and therefore final altitude) are adjusted.

When the segment following the descend-decel segment is a level, level-decel, level-idle, or land segment the input final altitude is maintained and the final true airspeed is adjusted to account for non-ISA conditions. The new final true airspeed (ft/s) is calculated as:

$$v'_{T_2} = \sqrt{\left( \left( \sqrt{\left( \sqrt{v_{T_1}^2 - w^2 \sin^2 \gamma} - w \cdot \cos \gamma \right)^2 + 2S_d a_{ISA} + w \cdot \cos \gamma} \right)^2 + w^2 \cdot \sin^2 \gamma \right)} \quad \text{Eq. 3-57}$$

where

$v'_{T_2}$  Calculated final true airspeed for actual airport atmospheric conditions (ft/s); and  
 $v_{T_1}$  Input initial true airspeed for actual airport atmospheric conditions (ft/s).

When the segment following the descend-decel segment is a descend, descend-decel, or descend-idle segment the input final true airspeed is maintained and the segment length and final altitude are adjusted for non-ISA conditions. The new segment length is calculated as:

$$S'_l = \frac{\left(\sqrt{v_{T_2}^2 - w^2 \cdot \sin^2 \gamma} - w \cdot \cos \gamma\right)^2 - \left(\sqrt{v_{T_1}^2 - w^2 \cdot \sin^2 \gamma} - w \cdot \cos \gamma\right)^2}{2 \cdot a_{ISA}} \quad \text{Eq. 3-58}$$

where

- $S'_l$  Segment length adjusted for non-ISA conditions (ft);
- $v_{T_1}$  Input initial true airspeed for actual airport atmospheric conditions (ft/s); and
- $v_{T_2}$  Input final true airspeed for actual airport atmospheric conditions (ft/s).

The segment's new final MSL altitude  $A'_2$  is calculated as:

$$A'_2 = A_1 - S'_l \cdot \sin \gamma \quad \text{Eq. 3-59}$$

where

- $A'_2$  Calculated final altitude (ft) MSL; and
- $A_1$  Input initial altitude (ft) MSL.

Descend-decel segment thrust values account for deceleration effects on thrust, unlike descent segments described in Section 3.6.2.7.7. Thrust is calculated with a force balance derived from SAE-AIR-1845<sup>3</sup> equation (A15) with an additional acceleration term:

$$\frac{F_n}{\delta} = \frac{W}{N \cdot \delta} \left( R \cdot \cos \gamma - \sin \gamma + \frac{a}{g} \right) \quad \text{Eq. 3-60}$$

where

- $\frac{F_n}{\delta}$  Corrected net thrust per engine (lbf);
- $W$  Aircraft weight (lbf);
- $\delta$  Pressure ratio at segment's altitude (dimensionless);
- $N$  Number of engines (dimensionless);
- $R$  Drag over lift coefficient that depends on flaps and gear setting (dimensionless);
- $a$  Aircraft acceleration along the velocity vector (ft/s<sup>2</sup>);
- $g$  Gravitational acceleration of Earth (ft/s<sup>2</sup>); and
- $\gamma$  Descent angle (positive by convention).

### 3.6.2.7.9 Idle Descend Step

An idle descend step models descent at a specific angle and idle thrust setting to a target AFE altitude and calibrated airspeed (KCAS), adjusting one of the targets to preserve the deceleration that would have been observed in an ISA. For this type of step, the initial AFE altitude, true airspeed (KTAS), and thrust are given from the previous segment. The final AFE altitude  $A_2$ , final calibrated airspeed  $v_2$ , and descent angle  $\gamma$  are user inputs, with the final altitude and final calibrated airspeed being input on the following segment. The final true airspeed, final thrust, and horizontal distance are calculated.

In AEDT, the initial AFE altitude and KCAS appear to be user inputs; however, a descend-idle segment is not actually calculated until the next segment is processed. This procedure is necessary so that an approach profile can start with a descend-idle segment.

Descend-idle segments are calculated in the same manner as descend-decel segments described in Section 3.6.2.7.8 with the exception of thrust. Idle thrust is a rated thrust specification (see Section 3.6.2.2.2). The initial and final idle thrust values are calculated using the initial and final altitude and speed values as appropriate.

#### 3.6.2.7.10 Level Step

A level step models level flight over a specific distance to a target calibrated airspeed (KCAS), neglecting deceleration effects. For this type of step, the initial AFE altitude, true airspeed (KTAS), and thrust are given from the previous segment. The final altitude  $A_2$ , final calibrated airspeed  $v_2$  (KCAS), and distance flown  $S_v$  are user inputs (the final altitude and speed must be the same as the initial values). The final thrust is calculated.

If the initial thrust is not the same as the final thrust (for example, the previous segment was a climb segment), then AEDT creates a 1,000 ft transition segment so that the major portion of the level segment is flown at constant thrust.

The corrected net thrust per engine is calculated by using SAE-AIR-1845<sup>3</sup> equation (A15) with zero descent angle:

$$\left(\frac{F_n}{\delta}\right)_2 = \frac{\left(\frac{W}{\delta}\right) \cdot R_f}{N} \quad \text{Eq. 3-61}$$

where

- $\left(\frac{F_n}{\delta}\right)_2$  Final corrected net thrust per engine (lbf) at altitude  $A_1 = A_2$ ;
- $W$  Profile weight (lbf);
- $\delta$  Pressure ratio at altitude  $A_1 = A_2$  (dimensionless); and
- $R_f$  Drag-over-lift coefficient that depends on flaps and gear setting (dimensionless).

#### 3.6.2.7.11 Deceleration-Sensitive Level Step

A deceleration-sensitive level step models level flight over a specific distance to a target calibrated airspeed (KCAS), adjusting the target speed to preserve the deceleration that would have been observed in an ISA. For this type of step, the step length, initial calibrated airspeed (KCAS), and step AFE altitude are user inputs. The initial true airspeed and segment altitude must match the final values from the previous segment. The final true airspeed is defined by the following segment, and the constant segment thrust is calculated.

The level-deceleration segment is calculated and then separated into two sub-segments. The first sub-segment is assigned a 1,000 ft ground distance. The corrected net thrust at the beginning of this segment is equal to the final value from the previous segment, and the corrected net thrust at the end of 1,000 ft is set equal to the level-decel thrust. If the original horizontal distance is less than 2,000 ft, one half of the segment distance is used to transition the thrust. The final thrust on the second sub-segment is also set to the level-decel thrust. Thus, the second segment is flown at constant thrust.

Another 1,000 ft sub-segment restores the thrust from the level-decel value to the appropriate initial thrust for the following segment. This sub-segment is created in the following segment.

AEDT assumes that the procedural profile using the level-decel segment is defined for ISA reference conditions at a sea-level airport. The deceleration that results over the segment given sea-level ISA conditions is assumed to remain constant even under non-sea level, non-ISA conditions, and other segment parameters are therefore modified for consistency under these conditions. Deceleration over the level-decel segment for ISA conditions is calculated as:

$$a_{ISA} = \frac{\left( \left( \frac{v_2}{\sqrt{\sigma_{ISA}}} - w \right) \cdot \frac{101.2686}{60} \right)^2 - \left( \left( \frac{v_1}{\sqrt{\sigma_{ISA}}} - w \right) \cdot \frac{101.2686}{60} \right)^2}{2 \cdot S_d} \quad \text{Eq. 3-62}$$

where

$a_{ISA}$	Acceleration for ISA conditions (ft/s <sup>2</sup> );
$v_1$	Input initial calibrated airspeed (kt);
$v_2$	Input final calibrated airspeed (kt);
$\sigma_{ISA}$	Air density ratio at segment MSL altitude (for ISA conditions);
$w$	Headwind (kt); and
$S_d$	Input horizontal distance (ft) for the segment.

For non-ISA conditions, the segment's ISA deceleration is held constant and the segment length is adjusted. The new segment length (horizontal distance) is calculated as:

$$s'_d = \frac{\left( \left( \frac{v_2}{\sqrt{\sigma}} - w \right) \cdot \frac{101.2686}{60} \right)^2 - \left( \left( \frac{v_1}{\sqrt{\sigma}} - w \right) \cdot \frac{101.2686}{60} \right)^2}{2 \cdot a_{ISA}} \quad \text{Eq. 3-63}$$

where

$s'_d$	Segment length (ft); and
$\sigma$	Air density ratio at segment altitude (for actual airport conditions).

The level-decel segment thrust is calculated with SAE-AIR-1845<sup>3</sup> equation (A15) with an additional acceleration term and zero climb angle:

$$\frac{F_n}{\delta} = \frac{W}{N \cdot \delta} \left( R + \frac{a}{g} \right) \quad \text{Eq. 3-64}$$

where

$\frac{F_n}{\delta}$	Corrected net thrust per engine (lbf);
$W$	Aircraft weight (lbf);
$\delta$	Pressure ratio at segment's altitude (dimensionless);
$N$	Number of engines (dimensionless);



---

<i>R</i>	Drag over lift coefficient that depends on flaps and gear setting (dimensionless);
<i>a</i>	Aircraft acceleration along the velocity vector (ft/s <sup>2</sup> ); and
<i>g</i>	Gravitational acceleration of Earth (ft/s <sup>2</sup> ).

#### 3.6.2.7.12 Level-Idle Step

An idle level step models level flight at idle thrust over a specific distance to a target calibrated airspeed (KCAS), adjusting the target speed to preserve the deceleration that would have been observed in an ISA. For this type of step, the step length, initial calibrated airspeed (KCAS), and step AFE altitude are user inputs. The initial true airspeed and segment altitude must match the final values from the previous segment. The final altitude is set equal to the initial value, the final true airspeed is set equal to the initial true airspeed of the following segment, and the segment's idle thrust values are calculated. The level-idle segment is calculated then separated into two sub-segments. The first sub-segment is assigned a 1,000 ft ground distance. The corrected net thrust at the beginning of this segment is equal to the final value from the previous segment, and the corrected net thrust at the end of 1,000 ft is set equal to the calculated initial idle thrust value. If the original horizontal distance is less than 2,000 ft, one half of the segment distance is used to transition the thrust. The final thrust on the second sub-segment is set to the calculated final idle thrust value.

Another 1,000 ft sub-segment restores the thrust from the final idle thrust value to the appropriate initial thrust for the following segment. This sub-segment is created in the following segment.

As for level-decel segments, AEDT assumes that the procedural profile using the level-idle segment was defined for ISA reference conditions at a sea-level airport. The deceleration that results over the segment given sea-level ISA conditions is assumed to remain constant even under non-sea level, non-ISA conditions, and other segment parameters are therefore modified for consistency under these conditions. The segment length for level-idle segments flown under non-ISA conditions is calculated using Eq. 3-62 and Eq. 3-63 from Section 3.6.2.7.11.

Idle thrust is a rated thrust specification (see Section 3.6.2.2.2). The initial and final idle thrust values are calculated using the constant segment MSL altitude and the initial and final speed values as appropriate.

#### 3.6.2.7.13 Fit-to-Track Step

A fit-to-track step models level flight over a specific distance. The distance is indeterminate from the perspective of the procedure definition, but is known at the time of profile calculation. This type of step only appears in procedure definitions for circuit profiles, but AEDT internally also adds a step of this type to the end of touch-and-go procedures. There are no user inputs for this type of step. For this type of step, the initial AFE altitude, true airspeed (KTAS), and thrust are given from the previous segment. The final altitude, true airspeed, and thrust are each the same as the corresponding initial values.

#### 3.6.2.7.14 Landing Ground Roll Step

A landing ground roll step models ground roll from touch down over a specific distance to a target calibrated airspeed (KCAS) and thrust setting. For this type of step, the initial and final AFE altitudes are given (the elevation of the touch-down end of the runway), the initial (landing) speed is calculated, the final roll-out true speed (KTAS) is calculated from a user-input calibrated speed  $v_2$ , the initial (landing) thrust is calculated, the final thrust is calculated from a user-input percentage value  $P$ , and the ground-roll distance  $S_b$  is user input.

The landing calibrated airspeed is calculated by using SAE-AIR-1845<sup>3</sup> equation (A13):

$$v_1 = D_f \cdot \sqrt{W} \quad \text{Eq. 3-65}$$

where

$v_1$	Calibrated airspeed (kt) just before landing;
$D_f$	Landing coefficient that depends on the flaps and gear setting (kt/ $\sqrt{\text{lbf}}$ ); and
$W$	Approach profile weight (lb); weight is assumed to remain constant for the entire approach profile.

The initial and final true speeds are calculated by:

$$v_{T_1} = v_1 / \sqrt{\sigma} \quad \text{Eq. 3-66}$$

$$v_{T_2} = v_2 / \sqrt{\sigma} \quad \text{Eq. 3-67}$$

where

$\sigma$	Density ratio at airport MSL altitude (dimensionless).
----------	--

The initial thrust  $(F_n/\delta)_1$  is calculated using the descent thrust equation with the landing descent angle, landing calibrated airspeed  $v_1$ , and airport elevation (see Section 3.6.2.7.7).

The user-input percentage of thrust may also be used to calculate the final thrust for the landing segment representing the level of reverse thrust, if supplied by the user. The final thrust  $(F_n/\delta)_2$  is calculated by:

$$\left(\frac{F_n}{\delta}\right)_2 = F_s \cdot \left(\frac{P}{100}\right) \quad \text{Eq. 3-68}$$

where

$\left(\frac{F_n}{\delta}\right)_2$	Corrected net thrust per engine (lb) at end of landing roll-out;
$F_s$	Static corrected net thrust per engine (an input parameter) (lb); and
$P$	Percentage of thrust (an input parameter).

If the aircraft NPD curves are in percentages, the value of thrust that is actually assigned to the flight path segment is the percentage value  $P$ ; it is used to directly access the noise tables.

#### 3.6.2.7.15 Decelerate Step

A decelerate segment models ground roll over a specific distance to a target calibrated airspeed (KCAS) and thrust. For this type of step, the initial and final AFE altitudes are given (the elevation of the touch-down end of the runway), the initial speed is given from the previous step, and the final speed is calculated from user-input calibrated speed and density ratio at the MSL altitude. The initial thrust is given from the previous step, the final thrust is calculated from user-input percentage of thrust (see Section 3.6.2.7.13), and the ground-roll distance is user input.

### 3.6.2.8 BADA 3 Climbout

A climbout phase is computed according to the BADA 3 model if all of the following are true:

- The ANP profile is a procedural departure.
- The ANP procedure has least 1 climb step.
- The ANP procedure has at least 1 acceleration step.
- The fastest CAS in the ANP procedure is less than the BADA 3 en-route climb CAS.
- The altitude specified for the last climb step in the ANP procedure is higher than both:
  - the final computed altitude of the final ANP acceleration step; and
  - the altitude at which 10,000 ft MSLP is reached.
- BADA 3 climbout at 10,000 ft MSLP is enabled.
  - Note: here we use the shorthand MSLP for "mean sea level or pressure", indicating that BADA 3 climbout can be triggered when the aircraft reaches either 10,000 ft MSL or 10,000 ft pressure altitude, at the option of the user.

If computed, the BADA 3 climbout phase begins at the later of:

- The point at which 10,000 ft MSL is reached; and
- The end of the final acceleration step.

This constitutes the Doc9911-BADA3 transition point. From there, a standard BADA 3 en-route climb phase is computed to the target altitude of the final climb step of the ANP procedure.

An introduction to specific details of the BADA 3 model can be found in Section 3.9.1.7.1. The computation of a standard BADA 3 en-route climb is described in the sub-sections of the present section.

#### 3.6.2.8.1 Overview of Standard BADA 3 En-route Climb Phase

A BADA 3 climb-out phase begins with a standard acceleration (as described in Section 3.9.1.7.2.1, excluding adjustments related to target climb angles) to the BADA 3 en-route climb CAS, if necessary. This is followed by a series of climbs, each at constant CAS or constant Mach number (as described in 3.6.2.8.2). Between the initial and final altitudes of the phase, climb steps end and begin at each of the following altitudes:

- 10,000 ft AFE
- The Mach transition altitude as computed per Section 3.9.1.7.1.2
- Every multiple of 2,000 ft above MSL.

#### 3.6.2.8.2 BADA 3 Constant-Speed climb

The aircraft climbs at constant CAS (if below the Mach transition altitude) or Mach number (if above the Mach transition altitude) to a target altitude, using the BADA Total-Energy Model. The initial altitude,  $A_1$ , is equal to the final altitude from the previous segment and the final altitude is known. The initial and final speed values are set according to the scheduled speed. The initial thrust is set equal to the final thrust from the previous segment. The segment length  $S$  and final thrust  $T_2$  are calculated.

The segment length  $S$  (ft) is calculated according to Eq. 3-50 with the average climb angle given by:

$$\gamma = \sin^{-1} \left( \frac{dh / dt}{\bar{V}_T} \right) \quad \text{Eq. 3-69}$$

where

$dh / dt$  average climb rate (m/s) (see below);  
 $\bar{V}_T$  average true airspeed (m/s):

$$\bar{V}_T = \frac{1}{2} \cdot (V_{T_i} + V_{T_f}) \quad \text{Eq. 3-70}$$

where

$V_{T_i}$  initial true airspeed (m/s) calculated from the constant climb CAS using Eq. 3-87 or the constant climb Mach number using Eq. 3-89; and

$V_{T_f}$  final true airspeed (m/s) calculated from the constant climb CAS using Eq. 3-87 or the constant climb Mach number using Eq. 3-89.

The average climb rate is calculated using the following equation based on BADA 3 equation 3.1-4:

$$\frac{dh}{dt} = \left( \frac{(T_{mid} + D_{mid}) \cdot \bar{V}_T \cdot C_{pow,red}}{m \cdot g} \right) \cdot f\{M\} \quad \text{Eq. 3-71}$$

where

$T_{mid}$  thrust (N) calculated at segment midpoint altitude  $A_{mid}$  using Eq. 3-160 through Eq. 3-164;

$A_{mid}$  segment midpoint altitude (ft):

$$A_{mid} = \frac{1}{2} \cdot (A_1 + A_2) \quad \text{Eq. 3-72}$$

$D_{mid}$  drag force (N) calculated at  $A_{mid}$  using Eq. 3-157;

$C_{pow,red}$  power reduction coefficient calculated using Eq. 3-165;

$m$  aircraft mass (kg);

$g$  gravitational acceleration of Earth ( $m/s^2$ ); and

$f\{M\}$  energy share factor calculated using Eq. 3-153 or Eq. 3-155, as appropriate, for altitude  $A_{mid}$ .

The final thrust  $T_2$  (N) is calculated using the following equation:

$$T_2 = (T_{max,climb2} - D_2) \cdot C_{pow,red} + D_2 \quad \text{Eq. 3-73}$$

where

$T_{max,climb2}$  maximum climb thrust (N) calculated at segment endpoint altitude  $A_2$  and segment endpoint true airspeed  $V_{T2}$  using Eq. 3-160 through Eq. 3-164;

$D_2$  drag force (N) calculated at  $A_2$  using Eq. 3-157; and

$C_{pow,red}$  power reduction coefficient calculated using BADA equation Eq. 3-165.

### 3.6.2.9 Discontinuity Smoothing

As seen in Section 3.6.2.7, AEDT models flight as a sequence of somewhat independent steps (we have seen this as procedure steps, but it can also be, for example flight from one trajectory target to the next, as discussed in Section 3.9.1). Discontinuities in speed or thrust can occur at the interface between two adjacent steps. This often happens, for example, if the two steps are computed at different thrust

settings (like Maximum Takeoff vs. Maximum Climb), or using different thrust models (like Doc 9911 vs BADA 3). AEDT smooths these discontinuities when they occur. Although this obscures what underlying modeling was used for step computations, it also prevents undesirable artifacts that can arise in noise contours when discontinuities are left in place.

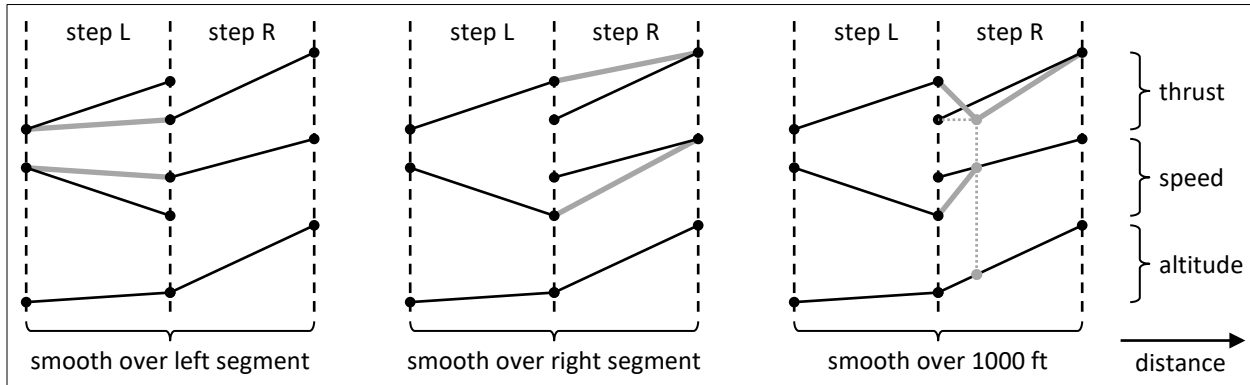

Figure 3-15 Smoothing of discontinuities at step interfaces. Modeled profiles (solid black with endpoints) show how thrust, speed, and altitude are actually modeled. Deviations in smoothed profiles from the modeled profiles are shown in grey.

Figure 3-15 illustrates the three ways in which AEDT smooths discontinuities at interfaces between steps:

- Smooth the discontinuities over the length of the step on the left. The smoothed speed and thrust profiles for step L vary linearly over its entire length from the step L's initial modeled values to step R's initial modeled values. The smoothed profiles for step R match its modeled profiles.
- Smooth the discontinuities over the length of the step on the right. The smoothed speed and thrust profiles for step R vary linearly over its entire length from step L's final modeled values to step R's final modeled values. The smoothed profiles for step L match its modeled profiles.
- Smooth the discontinuities over 1,000 ft. The smoothed profiles of step R have 2 sub-steps. The first sub-step has a horizontal length of the lesser of 1,000 ft and half of step R's horizontal length. Over the first sub-step, the smoothed thrust profile varies linearly from step L's final modeled thrust to step R's initial modeled thrust, while the smoothed speed profile varies linearly from step L's final modeled speed to step R's modeled speed at 1,000 ft in. Over the second sub-step, the smoothed thrust profile varies linearly from step R's initial modeled thrust to step R's final modeled thrust, while the smoothed speed profile matches step R's modeled speed profile. The smoothed profiles for step L match its modeled profiles. Note that, even though altitude isn't smoothed, the modeled altitude profile of step R is divided into substeps, consistently with the smoothed speed and thrust profiles. Also note that, if the horizontal length of step R is less than 2,000 ft, the discontinuity is smoothed over the first half of step R, rather than the first 1,000 ft.

At the interfaces between procedure steps computed according to Doc 9911, the discontinuities are smoothed as follows:

- If each of the steps is a level or descent step in an approach procedure, discontinuities are smoothed over the left step.

- Otherwise, discontinuities are smoothed over the first 1,000 ft of the right segment.

If a BADA 3 climbout phase is computed, discontinuities at the Doc9911-BADA3 transition are smoothed over the entire right segment (which is the en-route acceleration step).

### 3.6.3 Helicopter Profile

AEDT supports only one kind of flight profile input data for helicopters: an ordered set of procedure steps. Compared to fixed-wing aircraft, helicopter procedure steps are more similar to fixed-wing profile points than fixed-wing procedure steps. Like fixed-wing profile points, helicopter procedure steps explicitly define the flight profile, do not involve any flight performance calculations within AEDT, and are not modified by AEDT to account for non-standard atmospheric conditions. Unlike fixed-wing profile points, helicopter procedure steps are modal; they are defined as a set of procedure steps that each represents a helicopter flight operational mode.

The NPD data for helicopters used by AEDT reference operational modes and not thrust values. Available operational modes for helicopters include the following:

Dynamic operational modes include:

- Constant-velocity descent;
- Constant-velocity climb;
- Constant-velocity level;
- Vertical ascent with ground effect;
- Vertical ascent without ground effect;
- Vertical descent with ground effect;
- Vertical descent without ground effect;
- Level deceleration;
- Descending deceleration;
- Level acceleration;
- Ascending acceleration; and
- Taxi.

Static operational modes include:

- Idle with ground support;
- Idle without ground support;
- Hover with ground effect; and
- Hover without ground effect.

Each helicopter operational mode can have its own NPD curve that defines the source noise for that mode. There is only one NPD curve per mode, therefore there is no interpolation or extrapolation across helicopter NPD curves in AEDT. Note that AEDT does not require the existence of all modes. Thrust is not included in helicopter flight profiles.

An ordered set of helicopter procedure steps specifies a two-dimensional trajectory. For each point, the following data are given:

- Horizontal length (ft);

- Altitude of the helicopter above the helipad (ft);
- Helicopter groundspeed at the point (kts);
- Helicopter operational mode; and
- Time spent at a location for static operational modes (s).

The origin is where the computed horizontal coordinate is equal to zero, and it depends on the kind of flight operation:

- An approach origin is at the touchdown point and horizontal values are negative during descent.
- A departure origin is at the starting point on a helipad and horizontal values are positive.
- A taxi origin is at the starting point on a helipad and horizontal values are positive all the way to the end-point on the same or different helipad.
- An overflight origin is at the first point and horizontal values are positive.

For all types of operations, horizontal distance values increase as a helicopter flies along its profile. Profile speed is the ground speed at the profile point; it is the magnitude of the helicopter velocity vector. It is the same as true airspeed in cases where there is no wind. In the sections below, references to profile speed are talking about ground speed.

### 3.6.3.1 Helicopter Procedure Steps

Helicopter procedure steps explicitly define a helicopter's flight profile. There are no thrust, altitude, or speed calculations for helicopter flight profiles as there are for fixed-wing aircraft. All helicopter procedure step altitudes are in feet AFE. All helicopter procedure speeds are KTAS. The four types of helicopter flight operations (approach, departure, taxi and overflight) are created by using 14 types of procedure steps:

- **Start Altitude:** This step is used to start a profile at a given altitude and speed. The starting altitude and speed are inputs.
- **Constant-Velocity Level:** This step is used to maintain altitude and speed for a given distance. The track distance covered by the step is the only input. Altitude and speed are defined by the previous step.
- **Constant-Velocity Descent:** This step is used to descend at constant speed to a given altitude over a given distance. The track distance covered by the step and the final altitude are inputs. The initial altitude and speed are defined by the previous step.
- **Descending Deceleration:** This step is used to descend and decelerate to a final altitude and speed over a given distance. The track distance covered by the step, the final altitude, and the final speed are inputs. The initial altitude and speed are defined by the previous step.
- **Level Deceleration:** This step is used to decelerate to a final speed at constant altitude over a given distance. The track distance covered by the step and the final speed are inputs. The altitude and initial speed are defined by the previous step.
- **Vertical Descent:** This step is used to maintain horizontal position while descending to a final altitude over a given duration. The duration of the step and the final altitude are inputs. The horizontal position of the step is calculated from the previous step and the horizontal speed is zero.
- **Hover:** This step is used to maintain altitude and horizontal position for a given duration. The duration of the step is the only input. The altitude is defined by the previous step, the horizontal position of the step is calculated from the previous step, and the horizontal speed is zero.

- **Idle With Ground Support:** This step is used to maintain ground idle for a given duration. The duration of the step is the only input. The altitude is zero, the horizontal position of the step is calculated from the previous step, and the horizontal speed is zero.
- **Idle Without Ground Support:** This step is used to maintain flight idle for a given duration. The duration of the step is the only input. The altitude is zero, the horizontal position of the step is calculated from the previous step, and the horizontal speed is zero. Note that the noise modeling data used for flight idle segments is different from the noise data used for ground idle segments (modeled by “Idle with Ground Support” steps).
- **Vertical Climb:** This step is used to maintain horizontal position while ascending to a final altitude over a given duration. The duration of the step and the final altitude are inputs. The horizontal position of the step is calculated from the previous step and the horizontal speed is zero.
- **Level Acceleration:** This step is used to accelerate to a final speed over a given distance. The track distance covered by the step and the final speed are inputs. The altitude and initial speed are defined by the previous step.
- **Ascending Acceleration:** This step is used to climb and accelerate to a final altitude and speed over a given distance. The track distance covered by the step, the final altitude, and the final speed are inputs. The initial altitude and speed are defined by the previous step.
- **Constant-Velocity Climb:** This step is used to climb at constant speed to a given altitude over a given distance. The track distance covered by the step and the final altitude are inputs. The initial altitude and speed are defined by the previous step.
- **Taxi:** This step is used to taxi at a given constant speed. The speed is the only input. The track distance is calculated based on the assigned taxi ground track, and the altitude is defined by the previous step. AEDT allows helicopters defined as having wheels to taxi at zero altitude. Helicopters defined as not having wheels must taxi at an altitude greater than zero.

Some helicopter procedure steps correlate with different helicopter flight operational modes (and therefore different NPD and directivity data) depending on their altitude. When constructing flight paths with the Hover, Dep Vertical, and App Vertical procedure steps, AEDT calculates the ground effect altitude as follows:

$$A_{GE} = 1.5 \cdot D_{MR} \quad \text{Eq. 3-74}$$

where

$A_{GE}$  Ground effect altitude (ft AFE); and  
 $D_{MR}$  Main rotor diameter (ft, an input parameter).

If the procedure step stays below the ground effect altitude, the resulting trajectory segment is assigned the corresponding flight operational mode with ground effect. If the step stays at or above the ground effect altitude, the resulting trajectory segment is assigned the corresponding flight operational mode without ground effect. If a given Vertical Climb or Vertical Descent procedure step crosses the ground effect altitude, AEDT automatically divides the step into two at the ground effect altitude and assigns flight operational modes to the two steps as appropriate.



AEDT does not correct for non-standard temperature and pressure when generating helicopter flight profiles. This means that the input values of altitude, speed, and duration are used exactly as specified regardless of the atmosphere defined.

### 3.6.4 Flight Path Calculation

#### 3.6.4.1 3-D Flight Path Construction

A three-dimensional flight path is constructed by merging a two-dimensional profile (a set of distance vs. AFE altitude points) with a two-dimensional ground track (an ordered set of latitude, longitude points). Where there is a track point, a z-value is computed by interpolating between two points on the profile. Where there is a profile point, the (x, y) values are computed on the ground-track segment under the profile point. The result of this construction is an ordered set of (x, y, z) points and associated speed and thrust data that describe the flight path.

When a track point lies between two profile points, a linear interpolation method is used to calculate the altitude, speed, and thrust at that point:

$$z = z_1 + f \cdot (z_2 - z_1) \quad \text{Eq. 3-75}$$

$$v_t = v_{T_1} + f \cdot (v_{T_2} - v_{T_1}) \quad \text{Eq. 3-76}$$

$$\left(\frac{F_n}{\delta}\right) = \left(\frac{F_n}{\delta}\right)_1 + f \cdot \left[\left(\frac{F_n}{\delta}\right)_2 - \left(\frac{F_n}{\delta}\right)_1\right] \quad \text{Eq. 3-77}$$

$$\Delta v = v_{T_2} - v_{T_1} \quad \text{Eq. 3-78}$$

$$\Delta F = \left(\frac{F_n}{\delta}\right)_2 - \left(\frac{F_n}{\delta}\right)_1 \quad \text{Eq. 3-79}$$

where

$z$	Altitude at the interpolated point (ft AFE);
$f$	Fraction of the distance from profile point 1 to the interpolated point divided by the distance from profile point 1 to point 2 (dimensionless);
$z_1, z_2$	Initial and final profile altitudes (ft AFE);
$v_t$	Speed at the interpolated point (kt);
$v_{T_1}, v_{T_2}$	Initial and final profile point speeds (kt);
$(F_n / \delta)$	Corrected net thrust per engine (lbf) at the interpolated point;
$(F_n / \delta)_1$	Initial profile point corrected net thrust per engine (lbf); and
$(F_n / \delta)_2$	Final profile point corrected net thrust per engine (lbf).

#### 3.6.4.2 Flight Path Length Adjustments

After AEDT constructs the ordered set of flight path points, they are processed to remove points that are too close together. If two (x,y,z) points are closer than 10 ft, and if the speed and thrust data are the same, one of the points is removed from the set of points.

The last step in constructing a flight path is to insert points into segments that are too long. A path segment is subdivided if its length multiplied by the change in speed is greater than 100,000 ft-kts. The number of sub-segments is calculated by:

$$N = \text{int} \left( 1 + \sqrt{\frac{(v_{T_2} - v_{T_1}) \cdot L}{100,000}} \right) \quad \text{Eq. 3-80}$$

where

- $N$  Number of equal-distance sub-vectors (dimensionless);
- $\text{int}(x)$  Function that returns the integer part of a number  $x$ ; and
- $L$  Length of the vector (ft).

If the flight path segment is subdivided, the speed and thrust values at the end points of the equal-distance sub-segments are linearly interpolated by using the initial and final end-point values.

### 3.6.4.3 Optional Taxi Segment

To facilitate the computation of emissions metrics due to gate to runway taxi operations, AEDT uses taxi time values to calculate a taxi time-in-mode segment for arrival, departure and circuit airplane operations. If the user is using the higher-fidelity taxi trajectory modeling option (i.e., if they have enabled the delay-and-sequencing modeling option), a taxi time-in-mode is not computed (even if the operation has the taxi time data necessary to do so). Taxi time values are user specified and can be defined by airport average or flight operation. If both airport average and flight operation taxi times are defined and the appropriate emissions setting (“Enable flight-based taxi times”) is enabled, the flight operation taxi time takes precedence over the airport average taxi time. Therefore, one taxi segment (whose duration is equal to the flight taxi time) will be computed. If both airport average and flight operation taxi times are defined and the pertinent emissions setting is disabled, the flight operation taxi time is suppressed. One taxi segment (whose duration is equal to the airport average taxi time) would be computed.

The taxi segment has the following properties:

- Depending on the operation type, the following are identical to the first or last segment of the calculated flight path:
  - Geographic location (latitude and longitude)
  - Elevation
  - Time Stamp
  - Weather parameters
- The segment duration is defined as the user specified taxi time.
- The fuel flow rate is calculated using the engine specific unadjusted idle fuel flow rate.
- Fuel burn is calculated by multiplying the fuel flow rate by the segment duration and the number of engines.

The number of engines can be configured in the AEDT graphical user interface (GUI) to use all engines to calculate taxi fuel burn and emissions, rather than computing single engine taxi.

### 3.6.5 Bank Angle Treatment

The AEDT bank angle calculation methods are based on the guidance provided in the ICAO Doc 9911<sup>67</sup> (equation C-8):

$$\varepsilon = \tan^{-1} \left( 2.85 \frac{v_g^2}{rg} \right) \quad \text{Eq. 3-81}$$

where

$\varepsilon$	Bank angle (radians, positive in a left turn and negative in a right turn);
$v_g$	Ground speed (kts);
$r$	Turn radius (ft); and
$g$	Gravitational acceleration of Earth (ft/s <sup>2</sup> ).

There are two important assumptions inherent in this equation:

1. The aircraft is in a coordinated turn where the velocity vector is always aligned with the aircraft roll axis.
2. Speed and acceleration in the vertical plane is insignificant. The flight procedures typically used in close proximity to airports do not result in large speed and acceleration values in the vertical plane.

#### 3.6.5.1 Bank Angle Smoothing and Filtering

AEDT attempts to remove fluctuations in the bank angle through a sequence of smoothing, filtering, and limiting steps. The process is as follows:

1. Interpolate to stations every 0.5 nmi along the track.
2. Apply exponential smoothing.
3. Filter out fluctuations about zero.
4. Interpolate back onto original stations.
5. Apply upper limit.

The process is illustrated in Figure 3-16.

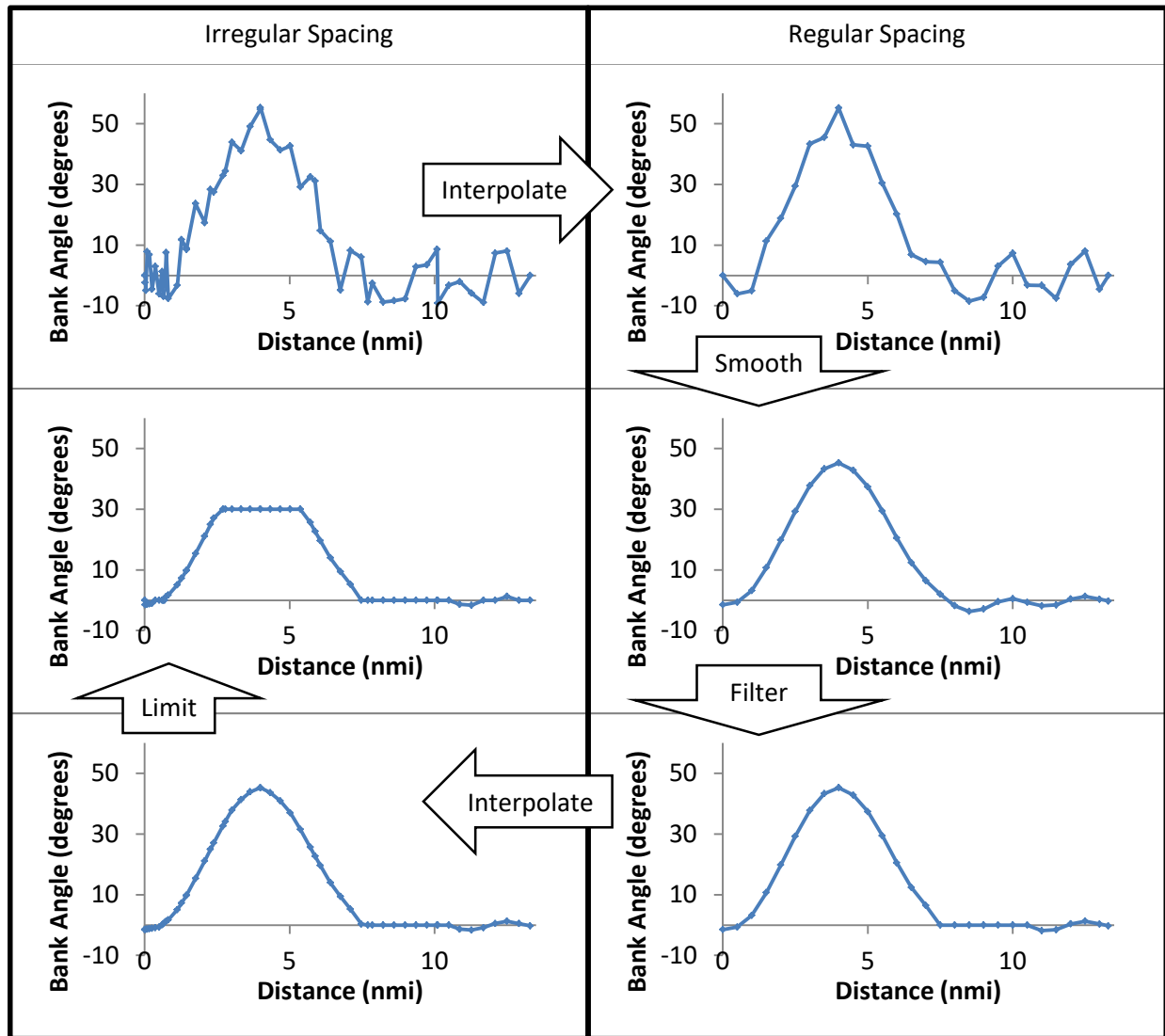

Figure 3-16 Example of Bank Angle Smoothing, Filtering, and Limiting

Interpolation at every 0.5 nmi leads to a collection of  $n$  bank angle samples,  $\varepsilon_i$ . The first sample  $\varepsilon_0$  is at a distance of zero and has the same value as the original first bank angle. The last sample  $\varepsilon_{n-1}$  is at the same distance as the original last bank angle, and has the same value (unlike the rest of the samples, the spacing between the last sample and its predecessor is not 0.5 nmi).

Exponential smoothing is similar to a moving average except that points are weighted exponentially. The smoothed value is calculated recursively as follows:

$$\varepsilon_{si} = (1 - b) \cdot \varepsilon_i + b \cdot \varepsilon_{si-1} \tag{Eq. 3-82}$$

where

- $\varepsilon_{si}$  Smoothed bank value at index  $i$ ;
- $b$  Smoothing parameter (dimensionless);
- $\varepsilon_i$  Unsmoothed bank value at index  $i$ ; and

$\varepsilon_{Si-1}$  Smoothed value at index  $i - 1$ .

The smoothing parameter  $b$  can have a range of values between 0 and 1. At  $b = 0$  there is no smoothing, and at  $b = 1$  all of the smoothed values are equal to the initial value. Between  $b$  values of 0 and 1, there are varying degrees of smoothing. The parameter is selected automatically in AEDT by using a variant of the signal to noise ratio on the calculated bank. The fluctuation magnitude  $N$  is defined as:

$$N = \frac{\text{median}(|\text{diff}(\varepsilon)|)}{\text{stdev}(\varepsilon)} \quad \text{Eq. 3-83}$$

where

stdev Standard deviation; and  
diff Point-by-point difference:

$$\text{diff}(\varepsilon_i) = \varepsilon_{i+1} - \varepsilon_i$$

Once fluctuation magnitude is calculated, the smoothing parameter is set to the smaller of two values:

$$b = \min(0.25 \cdot N, 0.5) \quad \text{Eq. 3-84}$$

This step limits the smoothing value to be between 0 and 0.5 regardless of maximum fluctuation magnitude.

The smoothing process is repeated ten times, forward and backward. The backward step removes biases introduced in the forward step. Repeated smoothing with a lower  $b$  value tends to reject high-frequency fluctuations more effectively than smoothing once with a higher  $b$  value.

After smoothing, the bank angles are filtered to ensure that data are compatible with typical flight operations. If the bank changes sign twice within a 30-second window, it is set to zero over the entire window. This step removes high-frequency oscillations caused by fluctuating data while preserving the actual aircraft banking.

After the bank angles are interpolated back from the smoothed and filtered equally spaced samples to the original path points, the final step is to limit bank angle values. If a bank angle has a magnitude less than 1 degree, it is set to zero degrees. If a bank angle exceeds a limit ( $\pm 30$  degrees), it is set to the limit value. Large bank angles may indicate a flight path with unrealistic combinations of turn radii and airspeed. If the flight path uses a points-type track, fluctuations in the track data may result in unrealistically fluctuating turning radii and extreme bank angle fluctuations. If the smoothing and filtering process fails to eliminate such fluctuations, users may improve their results by replacing the points-type track with a vector track. Turning radii in vector tracks are specified by the user, therefore all fluctuation can be removed.

### 3.6.5.2 Bank Angle Performance Effects

Aircraft banking affects flight performance because a portion of the aircraft's lift is directed horizontally instead of vertically. Aircraft performance is calculated under the assumption that the aircraft is not banking, so the calculated aircraft flight path must be adjusted to be consistent with banking.

### 3.6.5.2.1 Common Elements

Regardless of operation type, the adjustment for aircraft banking begins by calculating, for each segment, the drag to lift ratio and acceleration. Acceleration follows from initial and final segment speed along with segment length, according to uniform acceleration. Drag to lift ratio (dimensionless) comes from the force balance:

$$R_f = \frac{\left(\frac{F_n}{\delta} \frac{N\delta}{W} - \frac{a}{g} - \sin \gamma_A\right)}{\cos \gamma_A} \quad \text{Eq. 3-85}$$

where

$\frac{F_n}{\delta}$	Corrected net thrust per engine (lbf);
$N$	Number of engines (dimensionless);
$\delta$	Pressure ratio (dimensionless);
$W$	Aircraft weight (lbf);
$a$	Acceleration along the flight path (ft/s <sup>2</sup> );
$g$	Gravitational acceleration of Earth (ft/s <sup>2</sup> ); and
$\gamma_A$	Climb angle in the still-air frame of reference.

### 3.6.5.2.2 Approach

To account for the effects of bank angle on approach flight paths, AEDT increases thrust so that forces (thrust, drag, lift, and weight) are still in balance with banking effects in place. The initial thrust for each flight path segment  $F_n/d1$  is recalculated using the following force balance equation:

$$F = \left(\frac{a}{g} + \frac{R_f}{\cos(\varepsilon)} \cos \gamma_A + \sin \gamma_A\right) W \quad \text{Eq. 3-86}$$

where

$R_f$	Drag to lift ratio (dimensionless); and
$\varepsilon$	Bank angle.

### 3.6.5.2.3 Departure

To account for the effects of bank angle on departure flight paths, AEDT reduces the climb angle and speed in order to balance the forces. Thrust and acceleration are not altered. Note that the reduced speed results in a reduced bank angle because bank is a function of speed, so it is recalculated. The climb angle with banking effects is calculated by solving:

$$R_f \cdot \frac{\cos \gamma_2}{\cos \varepsilon_1} + \sin \gamma_2 = R_f \cdot \cos \gamma_1 + \sin \gamma_1 \quad \text{Eq. 3-87}$$

where

$\varepsilon_1$	Aircraft bank angle at start of segment after smoothing and filtering;
$\gamma_1$	Climb angle without banking effects; and
$\gamma_2$	Climb angle with banking effects.

The new segment length  $L_{new}$  (ft) is calculated as follows:

$$L_{new} = L \frac{\cos \gamma_1}{\cos \gamma_2} \quad \text{Eq. 3-88}$$

where

$L$  Length (ft) without banking effects.

Acceleration is held constant, so the new segment length must coincide with a change in endpoint speed to maintain consistency:

$$v_2^2 - v_1^2 = 2aL_{new} \quad \text{Eq. 3-89}$$

where

$a$  Aircraft acceleration along the velocity vector (ft/s<sup>2</sup>);  
 $v_1$  Aircraft true airspeed at start of vector (ft/s); and  
 $v_2$  Aircraft true airspeed at end of vector (ft/s).

The vector speed along the horizontal plane  $v_g$  (ft/s) is then:

$$v_g = \frac{v_1 + v_2}{2} \cos \gamma_2 \quad \text{Eq. 3-90}$$

The segment speed can be used with Eq. 3-25 to calculate a new bank angle at the end of the segment,  $\epsilon_2$ .

## 3.7 Doc 9911 - BADA 4 Analysis of Profile-Driven Flight Performance

### 3.7.1 Overview

AEDT supports BADA 4 analysis of flight performance for procedural profiles. This primarily relies on the BADA Total Energy Model (TEM) for flight kinetics modeling, but Doc 9911 analysis is applied to some kinematics and thrust computations.

When BADA 4 analysis is requested for an air operation with a fixed-point profile, analysis is performed as described in Section 3.6. While it may seem problematic to apply Doc 9911 analysis when BADA 4 was requested, this concern is unfounded because, for air operations with fixed-point profiles, flight performance modeling:

- Does not involve any airplane-specific data from any flight performance model;
- Does not involve any aspects of flight dynamics provided by the BADA 4 specification; and
- Involves some non-airplane-specific aspects of flight dynamics modeling that are provided by the Doc 9911 model.

### 3.7.2 Aircraft Types

Both the ANP and BADA 4 datasets include data for jet (turbofan), turboprop, and piston-engine aircraft types. AEDT only supports BADA 4 performance analysis for jet aircraft, which constitute 95 of 105 aircraft in the BADA 4.2.1 dataset. AEDT will provide a warning to the user if an aircraft with a combination of ANP model and BADA 4 model that is not approved for regulatory use by FAA is included in a metric result.

### 3.7.3 Aerodynamic Configuration Selection

The settings of an airplane's high-lift devices and landing gear comprise its aerodynamic configuration. Procedure step definitions can specify the aerodynamic configuration to be used for the step in two ways: as an ANP configuration and/or as a BADA 4 configuration. An ANP configuration is referred to as “flaps” or a “flaps setting”, though the particular ANP configuration may also include distinct landing gear and slat positions.

BADA 4-based computation of the aerodynamic forces acting on an aircraft during a procedure step requires a BADA 4 configuration. If the BADA 4 configuration is specified directly in the step definition, then AEDT uses the specified configuration in BADA 4 analysis of that step. If the step doesn't have a BADA 4 configuration, but has an ANP configuration, AEDT uses the BADA 4 configuration that corresponds to the specified ANP configuration, according to an ANP-to-BADA 4 mapping specific to the aircraft equipment (see Section 3.7.3.1). If the step has neither type of specification, the BADA 4 configuration is assigned based on the aerophase of the procedure step (see Section 3.7.3.2).

#### 3.7.3.1 ANP-to-BADA 4 Configuration Map

Each AEDT airplane is a union of ANP, EEDB or other published engine data, BADA Family 3, and for certain airplanes, BADA Family 4 data sources. Each airplane that includes a BADA 4 airplane in its composition will also be tied to an ANP airplane. When an airplane has both an ANP data and BADA 4 data, its definition includes a map from each ANP flap setting to a BADA 4 configuration. Table 3-6 shows a sample mapping dataset for an airplane composed of an A320-211 ANP airplane and an A320-212 BADA 4 airplane.

Table 3-6 ANP-to-BADA 4 Configuration Map for an AEDT Airplane Composed of an A320-211 ANP Airplane and an A320-212 BADA 4 Airplane

ANP ID	ANP Flap ID	BADA 4 Model	High-Lift Position Name	Landing Gear Position
A320-211	ZERO_A	A320-212	CLEAN	Gear Up
A320-211	ZERO	A320-212	CLEAN	Gear Up
A320-211	1_A	A320-212	CONF 1	Gear Up
A320-211	1	A320-212	CONF 1	Gear Up
A320-211	1+F	A320-212	CONF 1+F	Gear Up
A320-211	2_U	A320-212	CONF 2	Gear Up
A320-211	3_D	A320-212	CONF 3	Gear Down
A320-211	2_D	A320-212	CONF 3	Gear Down
A320-211	FULL_D	A320-212	FULL	Gear Down

Note that the penultimate record in Table 3-6 shows that requesting an ANP Flap ID of “2\_D” – which implies that the landing gear are deployed – results in a BADA 4 High-Lift configuration of “CONF\_3” with the gear deployed. The BADA 4 data do not contain a CONF\_2 with the gear deployed, which would be the expected match with the ANP data. The CONF\_3 configuration with the gear deployed was chosen as the closest match to the ANP “2\_D”, because the deployment of the landing gear was seen more important match than the flap/slots from an environmental perspective. Other aircraft in the AEDT database may also lack complete configuration overlap between ANP and BADA 4.



### 3.7.3.2 Aerophase-to-BADA 4 Configuration Map

The BADA Family 4 model and its datasets classify the phases of aircraft flight into five distinct values: takeoff, initial-climb, cruise, descent, and landing. These phases (deemed *aerophases*) are used by the BADA Family 4 model to categorize the different flight dynamics experienced by aircraft throughout different portions of the flight. The inclusion and use of aerophases by the BADA Family 4 model and datasets assists the aircraft trajectory modeling process by providing guidance with regard to the most suitable aerodynamic aircraft data to use throughout the distinct phases of flight.

For procedure steps without an ANP flap setting (e.g., idle-descend steps), the aerophase assigned to the procedure step is used as the basis to select a BADA 4 configuration. BADA 4 aircraft include a mapping of the default BADA 4 configuration to use for each aerophase.

### 3.7.4 Speed Conversions

In the BADA 4 analysis of procedure profiles, the conversion between the calibrated and true airspeeds as well as Mach number is achieved through BADA-specified relations. Note that in the equations below, the units of the calibrated and true airspeeds are meters per second, except when ANP ground roll procedures are used.

The following compressible flow equation yields true airspeed from calibrated airspeed:

$$v_{TAS} = \sqrt{\frac{2}{\mu} \cdot \frac{P}{\rho} \left\{ \left( 1 + \frac{P_0}{P} \cdot \left[ \left( 1 + \frac{\mu}{2} \cdot \frac{\rho_0}{P_0} \cdot v_{CAS}^2 \right)^{\frac{1}{\mu}} - 1 \right] \right)^{\mu} - 1 \right\}}, \mu = \frac{\gamma - 1}{\gamma}} \quad \text{Eq. 3-91}$$

where

$v_{TAS}$	Aircraft true airspeed [m/s];
$\rho$	Local atmospheric density [kg/m <sup>3</sup> ];
$P$	Local atmospheric pressure [N/m <sup>2</sup> ];
$P_0$	ISA sea-level pressure [N/m <sup>2</sup> ];
$\rho_0$	ISA sea-level density [kg/m <sup>3</sup> ];
$\mu$	Ratio of gas constant to specific heat at constant pressure [dimensionless]; and
$\gamma$	Isentropic expansion coefficient for air [dimensionless].

Calibrated airspeed is determined from true airspeed by the inverse of the previous relation:

$$v_{CAS} = \sqrt{\frac{2}{\mu} \cdot \frac{P_0}{\rho_0} \left\{ \left( 1 + \frac{P}{P_0} \cdot \left[ \left( 1 + \frac{\mu}{2} \cdot \frac{\rho}{P} \cdot v_{TAS}^2 \right)^{1/\mu} - 1 \right] \right)^{\mu} - 1 \right\}} \quad \text{Eq. 3-92}$$

Mach number is related to true airspeed by:

$$v_{TAS} = M \cdot \sqrt{\gamma \cdot R \cdot T} \quad \text{Eq. 3-93}$$

where

$v_{TAS}$	Aircraft true airspeed (m/s);
$R$	Real gas constant for air [m <sup>2</sup> / (K s <sup>2</sup> )];

$T$	Local atmospheric temperature [K]; and
$M$	Aircraft Mach number [dimensionless].

Groundspeed is obtained from:

$$v_g = v_{TAS} - w_h \quad \text{Eq. 3-94}$$

where

$v_g$	Aircraft groundspeed [m/s];
$v_{TAS}$	Aircraft true airspeed [m/s]; and
$w_h$	The magnitude (positive or negative) of headwind experienced by the aircraft [m/s].

### 3.7.5 Input Track Modeling

BADA 4 analysis of procedure profiles models performance for operations using either point or vector input tracks. Runway and runway end constraints (e.g., displaced threshold, crossing height) are also obeyed within BADA 4 modeling of procedural content. The application of these constraints can lead to the common situation in which the modeled ground track used by performance calculations differs slightly to the input ground track supplied to the system.

The chief difference between AEDT's Doc 9911 and BADA 4 track modeling, is that the Doc 9911 analysis projects the geographic coordinates which specify an input track (either explicitly in the case of point-tracks or implicitly in the case of vector tracks) into a 2-dimensional projected coordinate system. BADA 4 analysis does not project input track points and maintains them in a geographic coordinate system.

Each track point in the modeled ground track used in performance calculations has an associated distance from the start of the track. This distance is known as a track coordinate. The first track point has a track coordinate of zero while the last track point has a track coordinate equal to the total length of the modeled ground track. The determination of the exact geographic location of any calculated performance state is achieved by utilizing the horizontal movement of the calculated performance state as a means of determining the calculated state's track coordinate.

The procedural operation only traverses the portion of the modeled ground track that is required by the procedural profile. There is no extension of performance along the entire length of the ground track.

#### 3.7.5.1 Insertion of Interpolated Performance States

A 4-dimensional aircraft trajectory is computed one procedure-driven performance state at-a-time. By calculating the track coordinate of a newly-computed performance state, an algorithm determines if the newly-computed performance state overran one or more input ground track points. If so, an interpolated performance state for each overrun ground track point is added to the computed aircraft trajectory. An interpolated performance state that corresponds to an input ground track point is expected to appear in the final modeled aircraft trajectory.

If a newly-computed performance state is within 10 feet of overrun ground track point, an interpolated point for the overrun track point is not added to the computed aircraft trajectory because the near-enough computed performance state is considered to satisfy the ground track point's location.

The performance quantities (e.g., thrust, speeds, altitude) of an interpolated performance state are linearly interpolated from the performance states that bound the interpolated performance state. This calculation is described by:

$$x_{inter} = x_1 + f \cdot (x_2 - x_1), f = \frac{\ell_{inter} - \ell_1}{\ell_2 - \ell_1} \quad \text{Eq. 3-95}$$

where

$x_{inter}$	Interpolated value for general performance quantity;
$x_1$	Lower bound value of general performance quantity;
$x_2$	Upper bound value of general performance quantity;
$f$	Fractional distance [dimensionless] of interpolated state;
$\ell_{inter}$	Track-coordinate of interpolated performance state;
$\ell_1$	Track-coordinate of lower bound performance state; and
$\ell_2$	Track-coordinate of upper bound performance state.

### 3.7.6 Procedure Step Components

This section describes how each procedure step type is used in conjunction with BADA 4 airplane data to calculate the performance states for each individual procedure steps. A performance state is a 4-dimensional position (three spatial dimensions as well as time) of an aircraft in addition to other properties such as aircraft speed, thrust, and fuel burn. A complete set of such performance states defines a fully modeled 4-dimensional aircraft trajectory.

The calculation of thrust, drag, and fuel burn for each performance state computed during the processing of a procedure step is described in Section 3.7.8 Thrust, Section 3.7.9 Drag, and Section 3.7.10 Fuel Flow.

#### 3.7.6.1 Takeoff Step

In order to capture the large increase in speed experienced by an aircraft during ground roll, the takeoff procedure step is split into multiple segments based on speed in a similar (although not identical) fashion as described ICAO Doc 9911<sup>67</sup>. A more general form of the ICAO Doc 9911 equation (Doc 9911 Equation 3-4f) used to determine the number of segments into which a takeoff step is to be broken down into is:

$$n_{seg} = int \left( 1 + \frac{(v_2 - v_1)}{c_{speed}} \right) \quad \text{Eq. 3-96}$$

where

$n_{seg}$	Number of segments in takeoff ground roll when segmenting based on speed;
$int(x)$	Function that returns the integer part of $x$ ;
$v_1$	Initial takeoff speed;
$v_2$	Final takeoff speed (KCAS); and
$c_{speed}$	Speed segmentation constant, 20 KCAS.

ICAO Doc 9911 recommends that the takeoff ground roll be segmented on the basis of groundspeed. BADA 4 analysis uses a *calibrated speed* segmentation constant of 20 knots, as the basis for segmenting a takeoff procedure step.

## 3.7.6.1.1 Calculate End-Of-Ground-Roll Speed

The final calibrated airspeed (KCAS) at the end of ground roll is calculated by using SAE-AIR-1845 equation (A7):

$$v_2 = C_f \cdot \sqrt{W} \quad \text{Eq. 3-97}$$

where

$v_2$	Initial climb calibrated airspeed [knots];
$C_f$	Takeoff speed coefficient (obtained from procedure step flaps setting) [knots/ $\sqrt{\text{lbf}}$ ]; and
$W$	Departure profile weight [lbf].

## 3.7.6.1.2 Calculate Ground Roll Distance

Takeoff ground-roll distance is calculated by using SAE-AIR-1845 equation (A6):

$$S_g = \frac{B_f \cdot \theta \cdot \left(\frac{W}{\delta}\right)^2}{N \cdot \left(\frac{F_n}{\delta}\right)_2} \quad \text{Eq. 3-98}$$

where

$S_g$	Ground-roll distance [ft.];
$B_f$	Ground-roll coefficient, which depends on the flaps setting [ft./lbf];
$\theta$	Temperature ratio at the airport elevation [dimensionless];
$\delta$	Pressure ratio at the airport [dimensionless];
$N$	Number of engines supplying thrust; and
$\left(\frac{F_n}{\delta}\right)_2$	Corrected net thrust per engine [lbf] at the end of takeoff step.

The takeoff ground-roll distance is corrected for headwind, by using SAE-AIR-1845 equation (A16):

$$S_{gw} = \frac{S_g \cdot (v_2 - w)^2}{(v_2 - 8)^2} \quad \text{Eq. 3-99}$$

where

$S_{gw}$	Ground-roll distance [ft.] corrected for headwind;
$v_2$	Initial climb calibrated speed [knots]; and
$w$	Headwind at the start of ground roll [knots].

BADA 4 analysis does not apply the runway-gradient-based correction to ground roll length that is applied to the Doc 9911 analysis. This correction for runway gradient is discussed in Section 3.6.2.7.2 Takeoff Ground Roll Step.

## 3.7.6.1.3 Calculate Acceleration and Duration

The ground-based acceleration is assumed to be constant for each segment of the takeoff ground roll, and is calculated by:

$$a_{gr} = \frac{v_{g2}^2}{2 \cdot S_{gw}} \quad \text{Eq. 3-100}$$

where

$a_{gr}$  Ground-based acceleration [m/s<sup>2</sup>] experienced throughout ground roll; and  
 $v_{g2}$  Final ground roll groundspeed [m/s];

The time,  $t$ , to traverse each segment of the takeoff ground roll, is calculated as:

$$t_{dur} = \frac{(v_{g,2} - v_{g,1})}{a_{gr}}$$

where

$t$  The time [s] spent on traversing a segment of the ground roll;  
 $v_{g,2}$  The target groundspeed [m/s] of the current segment; and  
 $v_{g,1}$  The initial groundspeed [m/s] of the current segment.

#### 3.7.6.1.4 Calculate Track Length

The track length of the entire takeoff ground roll is equal to the quantity ( $S_{gw}$ ) defined in Eq. 3-99.

#### 3.7.6.2 Constant-CAS Climb Step

A constant-CAS climb procedure step attempts to climb to an AFE altitude specified by the procedure step itself while climbing at a constant calibrated airspeed whose value is equal to the calibrated airspeed of the performance state that corresponded to the end of the previous procedure step.

Constant-CAS step calculations are segmented based on 1,000 foot increments of altitude, with the exception of the initial climb step of a procedure profile. The initial climb step in a departure procedure profile is segmented based on a set of constant ICAO Doc 9911<sup>67</sup> initial-climb (above runway end) altitudes (shown in Table 3-7). In the event that the initial constant-CAS climb procedure step specifies a final altitude *lower* than any of the Doc 9911 initial climb step segmentation altitudes, then any Doc 9911 initial climb step segmentation altitudes will not appear in the performance states generated for the initial climb step (nor for any other subsequent steps).

Table 3-7 ICAO Doc 9911-Specified Initial Climb Procedure Step Segmentation Altitudes

Segment End Altitude Above Runway End (m)
18.9
41.5
68.3
102.1
147.5
214.9
334.9
609.6
1289.6

All subsequent climb steps are segmented such that a performance state is constructed for each 1,000-ft. increment above the runway end (ARE).

Calculation of performance states for each altitude target of a constant-CAS climb procedure step is described in the following subsections.

### 3.7.6.2.1 Calculate Energy Share

When determining the energy share for the initial performance state within a segment of a constant-CAS climb procedure step, a modified form of the equation for energy share for a constant-CAS climb below the tropopause is used. AEDT uses the actual local temperature gradient as well as the actual local pressure gradient in order to be able to model aircraft performance in non-ISA and/or non-Static atmospheres.

$$ES = \left( 1 + \frac{\kappa R}{2g_0} M^2 \frac{T - \Delta T}{T} + \frac{-\frac{dP}{dh} \left( 1 + \frac{\kappa - 1}{2} M^2 \right)^{\frac{-1}{\kappa - 1}} \left( \left( 1 + \frac{\kappa - 1}{2} M^2 \right)^{\frac{\kappa}{\kappa - 1}} - 1 \right) \right)^{-1} \quad \text{Eq. 3-101}$$

where

$ES$	Energy share [dimensionless] at a particular location along the aircraft trajectory;
$\kappa$	Adiabatic index of air [dimensionless];
$R$	Real gas constant of air [ $\text{m}^2/(\text{Ks}^2)$ ];
$g_0$	Gravitational acceleration [ $\text{m}/\text{s}^2$ ];
$\frac{dT}{dh}$	The observed rate of change of temperature with respect to increasing altitude [ $\text{K}/\text{m}$ ];
$-\frac{dP}{dh}$	The observed rate of change of pressure with respect to decreasing altitude [ $\text{Pa}/\text{m}$ ];
$T$	Local temperature of air [ $\text{K}$ ];
$\Delta T$	Temperature differential at mean sea level;
$\rho$	Local density of air [ $\text{kg}/\text{m}^3$ ]; and
$M$	Aircraft Mach number [dimensionless].

### 3.7.6.2.2 Calculate Drag and Thrust

Drag is determined per the BADA 4 drag model appropriate to the BADA 4 configuration of the aircraft. Thrust is calculated according to logic described in Section 3.7.8 Thrust.

### 3.7.6.2.3 Calculate Climb Rate and Acceleration

The instantaneous climb rate and acceleration of a particular performance state is determined using equations derived from the BADA's Total Energy Model (TEM). Climb rate and acceleration (with the air mass as the reference frame) are as follows:

$$ROC_1 = \frac{(Th_1 - D_1)v_{TAS,1}}{mg_0} \cdot ES \quad \text{Eq. 3-102}$$

$$a_{air,1} = \frac{(Th_1 - D_1)v_{TAS,1} - m_1g_0ROC_1}{m_1v_{TAS,1}}$$

where

$ROC_1$	Rate of climb [m/s] of the aircraft at the initial state of the current segment;
$a_{air,1}$	Aircraft acceleration [m/s <sup>2</sup> ] (in the direction of motion with respect to the air-mass);
$Th_1$	Total net thrust [N] across all aircraft engines at the initial state of the current segment;
$D_1$	Drag [N] experienced by the aircraft at the initial state of the current segment;
$m_1$	Aircraft mass [kg] of initial state of current segment;
$g_0$	Gravitational acceleration [m/s <sup>2</sup> ]; and
$v_{TAS,1}$	True airspeed [m/s] of the initial state of the current segment.

### 3.7.6.2.4 Calculate Time and Speed

The rate of climb and the acceleration of the aircraft at the current performance state is assumed to be constant from the current to the target performance state. The duration of the segment from the current to the target performance state is calculated as follows:

$$t_{dur} = \frac{(h_2 - h_1)}{ROC_1} \quad \text{Eq. 3-103}$$

where

$t_{dur}$	Total duration [s] of the segment;
$h_2$	The altitude [m] at the target state of the current segment; and
$h_1$	The altitude [m] at the initial state of the current segment;

The true airspeed (from which ground speed and Mach number are determined) of the target performance state is calculated as follows:

$$v_{TAS,2} = v_{TAS,1} + a_{air}t_{dur} \quad \text{Eq. 3-104}$$

where

$v_{TAS,2}$	True airspeed [m/s] at the target state of the current segment; and
$v_{TAS,1}$	True airspeed [m/s] at the initial state of the current segment.

### 3.7.6.2.5 Calculate Track Length

The track length for each segment of a climb step is defined by the following equation:

$$\ell_{seg} = \cos\left(\sin^{-1}\left(\frac{h_2 - h_1}{\bar{v}_g \cdot t_{dur}}\right)\right) \cdot \bar{v}_g \cdot t_{dur}, \quad \bar{v}_g = \frac{v_{g,2} + v_{g,1}}{2} \quad \text{Eq. 3-105}$$

where

$\ell_{seg}$	Track (horizontal) length [ft.] of the segment;
$\bar{v}_g$	Average groundspeed [ft./s] of the current segment;
$v_{g,2}$	Groundspeed [ft./s] at the target state of the current segment; and
$v_{g,1}$	Groundspeed [ft./s] at the initial state of the current segment;
$t_{dur}$	Total duration [s] of the segment;
$h_2$	The altitude [ft.] at the target state of the current segment; and
$h_1$	The altitude [ft.] at the initial state of the current segment.

### 3.7.6.3 Climb-Rate-Based and Percent-Based Acceleration Step

Climb-rate-based and percent-based acceleration procedure steps are both defined with a final target calibrated airspeed to be achieved by the procedure step. For the BADA 4 analysis of acceleration procedure steps, the steps are segmented such that the aircraft attempts to achieve calibrated airspeed targets that are repeatedly incremented by 5 knots until it reaches the final target of the procedure step.

#### 3.7.6.3.1 Calculate Speed and Thrust

Since the calibrated airspeed at the target state is a known quantity, an estimate of true airspeed at the target state is made by making use of a BADA true airspeed to calibrated airspeed conversion (that uses the atmospheric properties at the initial state of the current segment). Thrust at the target state of the current segment is similarly estimated using the atmospheric properties at the initial state.

#### 3.7.6.3.2 Calculate Drag

Drag is calculated per the BADA 4 drag model appropriate to the BADA 4 configuration of the aircraft. Acceleration segments are calculated in regions of 5 knot increases in airspeed; this BADA 4-specific method of breaking the acceleration segments into shorter, speed-increment-based segments allows the TEM methods to use the high-fidelity BADA 4 drag models to account for the increase in drag due to increasing speed. Thrust is calculated according to logic described in Section 3.7.8 Thrust.

#### 3.7.6.3.3 Calculate Acceleration

Calculation of the acceleration experienced by the aircraft during the procedure step depends on whether the procedure step is a climb-rate-based or a percent-based acceleration procedure step. For climb-rate-based acceleration procedure steps, the air-mass-based acceleration is computed as follows:

$$a_{air,1} = \frac{(Th_{avg} - D_1)v_{TAS,1} - m_1 g_0 ROC_1}{m_1 v_{TAS,1}} \quad \text{Eq. 3-106}$$

where

$a_{air,1}$	Aircraft acceleration [m/s <sup>2</sup> ] (in the direction of motion with respect to the air-mass);
$ROC_1$	Rate of climb [m/s] at initial state of the current segment (imposed by the step);
$Th_{avg}$	Average total thrust [N] across all aircraft engines (set equal to thrust at initial state);
$D_1$	Drag [N] at initial state of current segment experienced by the aircraft;
$m_1$	Aircraft mass [kg] at initial state of the current segment;
$g_0$	Gravitational acceleration [m/s <sup>2</sup> ]; and
$v_{TAS,1}$	Aircraft true airspeed [m/s] at the initial state of the current segment.

For percent-based acceleration procedure steps, acceleration is calculated using the equations that constitute Eq. 3-102 with the exception that the percent associated with the percent-based acceleration procedure step is substituted for the energy share term.

#### 3.7.6.3.4 Calculate Duration and Target Altitude

The duration of the segment from the current to the target state is calculated using:

$$t_{dur} = \frac{(v_{TAS,2} - v_{TAS,1})}{a_{air,1}} \quad \text{Eq. 3-107}$$

where



$t_{dur}$	Total duration [s] of the segment;
$v_{TAS,2}$	The estimated true airspeed [m/s] at the target state of the current segment; and
$v_{TAS,1}$	The true airspeed [m/s] at the initial state of the current segment.

The altitude achieved at the target state is computed as follows:

$$h_2 = h_1 + ROC_1 \cdot t_{dur} \quad \text{Eq. 3-108}$$

where

$h_2$	Altitude [m] achieved at the target state of the current segment; and
$h_1$	Altitude [m] at the initial state of the current segment.

### 3.7.6.3.5 Calculate Track Length

The track length of each segment of an acceleration step is defined by Eq. 3-105.

### 3.7.6.4 Descend Step

#### 3.7.6.4.1 Altitude-Based Segmentation

Descend procedure steps are defined by a start AFE altitude, start calibrated airspeed, and the geometric angle at which the aircraft is to descend. This step type flies to the altitude and calibrated airspeed specified by the next procedure step. The BADA 4 analysis of descend procedure steps segments a procedure step on the basis of altitude. Instead of immediately generating a performance state at the end of the procedure step, the algorithm computes a performance state 1,000 ft less than its current altitude until it reaches the altitude specified at the end of the procedure step. The target calibrated airspeeds at each of the target altitudes are derived from a linear interpolation of the calibrated airspeed at the start and end of the descent procedure step.

Steps whose vertical altitude decreases by less than 1,000 ft will not experience this type of segmentation, instead descending directly from their start to the final target altitude/speed.

#### 3.7.6.4.2 Calculate Target Altitude and Speed

Since the target AFE altitude and calibrated airspeed are known, an estimate of target true airspeed, Mach number, and ground speed can be calculated using weather sampled at the target altitude. These calculated speed quantities are considered estimates since the weather sampling is performed at the latitude, longitude, and time (a full date and time-of-day) of the current performance state.

#### 3.7.6.4.3 Calculate Flight Descent Angle

For air-mass-based calculations, the air-mass-based flight angle is determined using the following equation:

$$A = \frac{1}{\tan \gamma}, B = \frac{w_h}{\bar{v}_{TAS}}, Q = \sqrt{A^2 - B^2 + 1}, \bar{v}_{TAS} = \frac{v_{TAS,2} + v_{TAS,1}}{2} \quad \text{Eq. 3-109}$$

$$\alpha = \sin^{-1} \left( \frac{-BA - Q}{A^2 + 1} \right)$$

where

$\alpha$	The flight angle [rad] of the segment;
$\gamma$	The descent angle [rad] of the segment (and of the procedure step);

$w_h$	The magnitude of the headwind [knots] experienced by the aircraft;
$v_{TAS,1}$	Aircraft true airspeed [knots] of initial state of current segment;
$v_{TAS,2}$	The true airspeed [knots] of final state of current segment; and
$\bar{v}_{TAS}$	The average true airspeed [knots] for the segment.

#### 3.7.6.4.4 Calculate Duration, Drag, & Thrust

The duration of the segment is estimated as:

$$t_{dur} = \frac{h_2 - h_1}{\bar{v}_{TAS} \cdot \sin \alpha} \quad \text{Eq. 3-110}$$

where

$t_{dur}$	Duration [s] of the segment;
$h_1$	Altitude [m] of the initial state of the current segment; and
$h_2$	Altitude [m] of the target state of the current segment.
$\bar{v}_{TAS}$	The average true airspeed [knots] for the segment.

Drag is calculated per the BADA 4 drag model appropriate to the BADA 4 configuration of the aircraft. Thrust is calculated according to logic described in Section 3.7.8 Thrust.

By using the calculated drag, an estimate of thrust is produced for the initial state of the current segment. The estimate of thrust for the initial state is based on the BADA TEM and is expressed as:

$$Th_1 = D_1 + m_1 \left( g_0 \sin \alpha + \frac{v_{TAS,2} - v_{TAS,1}}{t_{dur}} \right) \quad \text{Eq. 3-111}$$

where

$Th_1$	Thrust [N] at initial state of current segment for all engines;
$D_1$	Drag [N] at initial state of current segment; and
$m_1$	Aircraft mass [kg] of initial state of current segment.

#### 3.7.6.4.5 Calculate Track Length

The track length of each segment of a descend step is defined by Eq. 3-105.

### 3.7.6.5 Descend-Idle Step

#### 3.7.6.5.1 Altitude-Based Segmentation

Altitude segmentation for descend-idle procedure steps is the same as for descend procedure steps, described in Section 3.7.6.4.1 Altitude-Based Segmentation.

#### 3.7.6.5.2 Calculate Target Altitude and Speed

The calculation of each target AFE altitude in addition to speeds (true airspeed, groundspeed, and Mach number) is performed the same as for descend procedure steps, described in Section 3.7.6.4.2 Calculate Target Altitude and Speed.

### 3.7.6.5.3 Calculate Flight Descent Angle

The calculation of flight descent angle is performed the same as for descend procedure steps, described in Section 3.7.6.4.3 Calculate Flight Descent Angle.

### 3.7.6.5.4 Calculate Duration & Thrust

Duration of a flight segment within a descend-idle procedure step is performed on the basis of the computed groundspeed of current performance state (i.e., the starting point of the segment) and the target performance state (i.e., the end point of the segment).

$$t_{dur} = \frac{h_1 - h_2}{\bar{v}_g \tan \gamma}, \quad \bar{v}_g = \frac{v_{g,1} + v_{g,2}}{2} \quad \text{Eq. 3-112}$$

where

$t_{dur}$	Duration [s] of the segment;
$h_1$	Altitude [ft.] of the initial state of current segment;
$h_2$	Altitude [ft.] of the target state of the current segment;
$\gamma$	Descend angle [rad] of the segment (and of the procedure step);
$\bar{v}_g$	Average groundspeed [ft./s] of the segment;
$v_{g,1}$	Groundspeed [ft./s] of the initial state of the current segment; and
$v_{g,2}$	Groundspeed [ft./s] of the target state of the current segment.

In contrast to the TEM-based thrust calculation for descend procedure steps, descend-idle procedure steps use the idle thrust rating of the propulsive forces model of their BADA 4 aircraft.

### 3.7.6.5.5 Calculate Track Length

The track length consumed by each segment of a descend-idle step is defined by the relations in Eq. 3-105.

### 3.7.6.6 Descend-Decelerate Step

Since the methodology used to calculate performance for a descend procedure steps considers the possibility that the step subsequent to the descend procedure step specifies a calibrated airspeed that is less than the calibrated airspeed of the descend procedure step, that same descend step methodology is used to calculate aircraft performance for a descend-decelerate procedure step in the BADA 4 analysis of procedure profiles.

### 3.7.6.7 Level Step

Level procedure steps typically occur in certain types of arrival procedures profile, but also occur in the middle of circuit and beginning and end of touch-and-go procedure profiles. Level procedure steps are not segmented based on speed, altitude (since it is constant), or length.

For level steps flown in an arrival procedure step or in the arrival-like portions of either a circuit or touch-and-go procedure profile, the assignment of aerophase depends on the altitude of the level procedure step. When the level step occurs at or below the maximum altitude for the landing aerophase, then aerophase is set explicitly as the landing aerophase. Aerophase is set as the approach aerophase otherwise.

For level procedure steps flown in the departure-like portion of either a circuit or touch-and-go procedure profile, aerophase is set as the initial climb aerophase.

#### 3.7.6.7.1 Calculate Speeds

The calibrated airspeed of the end point of a level procedure step is set equal to the calibrated airspeed of the next procedure step (in the case of level steps in an arrival profile or in the arrival portion of a touch-and-go or circuit profile), or the calibrated airspeed of the level step itself (in the case of level steps in the departure portion of a touch-and-go or circuit profile).

From calibrated airspeed, estimates are generated for the true airspeed, Mach number, and groundspeed of the target performance state. These calculated speed values are considered estimates since the weather reading from which the atmospheric properties used to derive these quantities is sampled at the same time and location as the initial performance state of the step.

#### 3.7.6.7.2 Calculate Duration and Acceleration

The duration of the level step is calculated as follows:

$$t_{dur} = \frac{\ell}{\bar{v}_g}, \quad \bar{v}_g = \frac{v_{g,1} + v_{g,2}}{2} \quad \text{Eq. 3-113}$$

where

$t_{dur}$	Duration [s] of the segment;
$\ell$	Length [ft.] of level step;
$\bar{v}_g$	Average groundspeed [ft./s] of the segment;
$v_{g,1}$	Groundspeed [ft./s] of the initial state of the current segment; and
$v_{g,2}$	Groundspeed [ft./s] of the target state of the current segment.

The air-mass-based acceleration (or deceleration) of the level procedure step is calculated by the following equation:

$$a_{air} = \frac{v_{TAS,2} - v_{TAS,1}}{t_{dur}} \quad \text{Eq. 3-114}$$

where

$a_{air}$	Acceleration [m/s <sup>2</sup> ] (in the direction of motion with respect to the air-mass) of the aircraft;
$v_{TAS,1}$	The true airspeed [m/s] at the initial state of the current segment; and
$v_{TAS,2}$	The true airspeed [m/s] at the target state of the current segment.

#### 3.7.6.7.3 Calculate Drag & Thrust

Drag is calculated per the BADA 4 drag model appropriate to the BADA 4 configuration of the aircraft. Thrust is calculated according to logic described in Section 3.7.8 Thrust.

Thrust for the initial state of the level segment is calculated in the same manner as Eq. 3-111 except that the flight angle term is zero. When there is no change in speed, Eq. 3-111 reduces to:

$$Th_1 = D_1 \quad \text{Eq. 3-115}$$

where

$Th_1$  Thrust [N] at initial state of the current segment for all engines; and  
 $D_1$  Drag [N] at initial state of the current segment.

#### 3.7.6.7.4 Calculate Track Length

The track length for a level step is defined by Eq. 3-105.

#### 3.7.6.8 Level-Idle Step

Level-idle procedure steps are not segmented and only one target performance state is calculated for the procedure step.

##### 3.7.6.8.1 Calculation of Speed Properties

The calibrated airspeed of the end point of a level-idle procedure step is set equal to the calibrated airspeed of the next procedure step.

Calculation of the speed properties derived from calibrated airspeed (i.e., true airspeed, Mach number, and groundspeed) are accomplished in the same way as a level procedure step. These derived speed properties are considered to be estimates since the weather reading used to calculate the derived speed properties is sampled at the same time/location as the initial performance state of the level-idle step.

##### 3.7.6.8.2 Calculate Duration & Thrust

The calculation of the duration of the level-idle segment is dependent on whether there is a change in calibrated airspeed associated with the level-idle procedure step. In the event that there is not a change in calibrated airspeed, segment duration is calculated by Eq. 3-113.

When there is a change in calibrated airspeed, segment duration is calculated by Eq. 3-116:

$$t_{dur} = \frac{v_{g,2} - v_{g,1}}{a_{gr}} \quad \text{Eq. 3-116}$$

$$a_{gr} = \frac{v_{g,2}^2 - v_{g,1}^2}{2\ell}$$

where

$t_{dur}$  Duration [s] of the segment;  
 $v_{g,1}$  Groundspeed [ft./s] of the initial state of the current segment;  
 $v_{g,2}$  Groundspeed [ft./s] of the target state of the current segment;  
 $a_{gr}$  Aircraft acceleration [feet/s<sup>2</sup>] (in the direction of motion with respect to the ground);  
 and  
 $\ell$  Length [ft.] of level-idle step.

Level-idle procedure steps use the idle thrust rating of the propulsive forces model of their BADA 4 aircraft.

##### 3.7.6.8.3 Calculate Track Length

Track length for a level-idle step is defined by Eq. 3-105, and is equal to the step's defined distance.

### 3.7.6.9 Level-Decelerate Step

Level-decelerate procedure steps begin with the final target calibrated airspeed to be achieved by the procedure step. The BADA 4 analysis of level-decelerate procedure steps segments the procedure step such that the aircraft attempts to achieve calibrated airspeed targets that are repeatedly decremented by 5 knots until it reaches the final target of the procedure step.

#### 3.7.6.9.1 Calculate Speed Properties

The calibrated airspeed of the end point of a level-decelerate procedure step is set equal to the calibrated airspeed of the next procedure step.

Calculation of the speed properties derived from calibrated airspeed (i.e., true airspeed, Mach number, and groundspeed) are accomplished in the same way as a level procedure step. These derived speed properties are considered to be estimates since the weather reading used to calculate the derived speed properties is sampled at the same time/location as the initial performance state of each segment of a level-decelerate step.

#### 3.7.6.9.2 Calculate Duration & Acceleration

When there is a change in calibrated airspeed for a level-decelerate step, segment duration is calculated by Eq. 3-116.

When there is no decrease in calibrated airspeed, segment duration is calculated by Eq. 3-113.

#### 3.7.6.9.3 Calculate Drag & Thrust

Drag is calculated per the BADA 4 drag model appropriate to the BADA 4 configuration of the aircraft. Thrust is calculated according to logic described in Section 3.7.8 Thrust.

By using the calculated drag, an estimate of thrust is produced for the initial state of the current segment. This estimate is based on the BADA TEM and is expressed as:

$$Th_1 = D_1 + m_1 \left( \frac{v_{TAS,2} - v_{TAS,1}}{t_{dur}} \right) \quad \text{Eq. 3-117}$$

where

$Th_1$	Thrust [N] at initial state of the current segment for all engines;
$D_1$	Drag [N] at initial state of the current segment; and
$m_1$	Aircraft mass [kg] initial state of current segment.

#### 3.7.6.9.4 Calculate Track Length

Track length for a level-decelerate step is defined by Eq. 3-105, and is equal to the step's defined distance.

### 3.7.6.10 Landing Step

Landing procedure steps are the portion of an aircraft's landing on the runway before the aircraft begins decelerating (for arrival and circuit procedure profiles) or accelerating (for touch-and-go procedure profiles). Even though a landing procedure step can model an aircraft deceleration, no segmentation on the basis of speed is performed on the procedure step.

#### 3.7.6.10.1 Calculate Speed Properties

The calibrated airspeed of the end point of a landing procedure step is set equal to the calibrated airspeed of the next procedure step.

From calibrated airspeed, estimates are generated for the true airspeed, Mach number, and groundspeed of the target performance state. These calculated speed values are considered estimates since the weather reading from which the atmospheric properties used to derive these quantities is sampled at the same time and location as the initial performance state of the step.

#### 3.7.6.10.2 Calculate Duration

Duration is calculated by Eq. 3-113.

#### 3.7.6.10.3 Calculate Thrust

The initial performance state of a landing step receives its value of thrust from the previous procedure step while the target (final) performance state of the landing step receives its thrust value from the next procedure step.

#### 3.7.6.10.4 Calculate Track Length

The track length of a landing step is equal to the step's defined distance.

### **3.7.6.11 Landing-Decelerate Step**

Landing-decelerate procedure steps are used to model the deceleration of an aircraft landing on a runway (referred to as reverse-thrust landing-decelerate steps) as well as a cap signifying the end of an aircraft's movements on the runway (referred to as end landing-decelerate steps). Modeling of landing-decelerate procedure steps is performed such that each segment nominally models a decrease of 20 knots in groundspeed.

#### 3.7.6.11.1 Calculate Speed Properties

A landing-decelerate procedure step models segments with successively decreasing groundspeed targets. The derived speed properties of each target performance state modeled by a landing-decelerate step are true airspeed, calibrated airspeed, and Mach number.

The calibrated airspeed target of the next procedure step is interpreted as a groundspeed target.

These derived speed properties of a target performance state are considered estimates since the conversion of groundspeed to the other speed properties at the target state used a weather reading taken at the time and location of the performance state previous to the target state.

#### 3.7.6.11.2 Calculate Duration

The duration of a landing-decelerate procedure step segment is calculated by Eq. 3-116.

#### 3.7.6.11.3 Calculate Thrust

The thrust calculated for the initial performance state of landing-decelerate procedure step is equal to a percent of the static thrust of the ANP aircraft dictated by the procedure step. The thrust for the final performance state of the landing-decelerate procedure step is equal to the percent of static thrust of the ANP aircraft dictated by the next procedure step (which is an end landing-decelerate procedure step).

This type of thrust modeling is discussed in Section 3.6.2.7.14 Landing Ground Roll Step.

#### 3.7.6.11.4 Calculate Track Length

The track length for a landing-decelerate step is defined by Eq. 3-105.

### 3.7.7 Behavior Above 10K MSL

The BADA 4 analysis of procedure profiles limits departure procedures to below 10,000 ft MSL. At and above 10,000 ft MSL, obedience to procedure steps is abandoned and a departure operation will instead fly under different behavior (described below) until it reaches 10,000 feet above the departure runway end (ARE).

For takeoff procedure steps where the departing runway elevation is at or above 10,000 ft MSL, operations only model the procedural profile's takeoff step (no airborne procedure steps from the aircraft's profile are modeled). The airborne trajectory is computed using the methodologies described in this section.

At 10,000 ft MSL, the behavior of the departing aircraft depends on whether the aircraft's calibrated airspeed is lower than the BADA 4 aircraft-specific climb-out calibrated airspeed. Aircraft at or above this calibrated airspeed will climb at constant calibrated airspeed to 10,000 ft ARE. Aircraft below the climb-out calibrated airspeed will climb using a CAS-acceleration to the climb-out calibrated airspeed. If the 10,000 ft ARE altitude has still not been reached, then the operation flies a constant-CAS climb to the aircraft-specific Mach transition altitude.

All computed departure profiles are clipped such that they terminate at exactly 10,000 ft ARE.

#### 3.7.7.1 Accelerate to Climb-Out Calibrated Airspeed

The acceleration to the aircraft-specific climb-out calibrated airspeed is segmented based on calibrated airspeed increments of 5 knots. The aircraft is constrained to perform its increasing-CAS climb at an energy share factor of 0.3.

$$D = C_D \frac{1}{2} \rho V_T^2 S \quad \text{Eq. 3-118}$$

where

$\rho$	Local density [kg/m <sup>3</sup> ];
$V_T$	Local aircraft true airspeed [m/s];
$S$	Aircraft-specific wing reference area [m <sup>2</sup> ]; and
$C_D$	Aircraft drag coefficient [dimensionless].

$$C_L = \frac{2mg_0}{\rho V^2 S \cos \theta} \quad \text{Eq. 3-119}$$

$$L = C_L \frac{1}{2} \rho V^2 S \quad \text{Eq. 3-120}$$

where

$C_L$	Energy share [dimensionless] at a particular location along the aircraft trajectory;
$m$	Current aircraft mass [kg];
$\rho$	The observed local density [kg/m <sup>3</sup> ];
$S$	BADA 4 aircraft wing reference area [m <sup>2</sup> ]; and



$\theta$  Aircraft bank angle [rad].

### 3.7.7.1.1 Calculate Climb Rate & Acceleration

The rate of climb as well as the air-mass-based acceleration of the initial state of the current segment are calculated by Eq. 3-102.

### 3.7.7.1.2 Calculate Segment Final Altitude

The segment final MSL altitude is determined by solving the following equation by Secant Method iteration:

$$v_{TAS,2}^2 - v_{TAS,1}^2 = 2g_0 \cdot \frac{1 - ES}{ES} \cdot (h_2 - h_1) \quad \text{Eq. 3-121}$$

where

$v_{TAS,2}$	True airspeed [m/s] at the target state of the current segment;
$v_{TAS,1}$	True airspeed [m/s] at the initial state of the current segment;
$g_0$	Gravitational acceleration [m/s <sup>2</sup> ];
$h_2$	MSL Altitude [m] at the target state of the current segment;
$h_1$	MSL Altitude [m] at the initial state of the current segment; and
$ES$	Energy share [dimensionless] imposed on the current segment.

An initial guess for the target state of the current segment is provided to the iteration algorithm. The target true airspeed is generated from the known value of the target calibrated airspeed in conjunction with a weather reading sampled at the geographic location (latitude, longitude) and time of the initial state, but at the altitude of the target state. The target true and calibrated airspeeds may have units of knots, but these are converted to meters per second prior to use in eq. 3-106.

### 3.7.7.1.3 Calculate Segment Geometry

The geometry of the segment is calculated by the following:

$$\ell_z = h_2 - h_1, \ell_{xyz} = \frac{\ell_z m_1 g_0}{ES \cdot (Th_2 - D_2)} \quad \text{Eq. 3-122}$$

$$\gamma = \sin^{-1} \frac{\ell_z}{\ell_{xyz}}, \ell_{xy} = \ell_{xyz} \cdot \cos \gamma$$

where

$\ell_z$	Vertical displacement [m] of the current segment;
$\ell_{xyz}$	Total length [m] traversed by the aircraft in the current segment;
$\ell_{xy}$	Horizontal displacement [m] of the current segment;
$h_2$	Altitude [m] at the target state of the current segment;
$h_1$	Altitude [m] at the initial state of the current segment;
$Th_2$	Calculated thrust (across all engines) [N] for the target state of the current segment;
$D_2$	Calculated drag [N] for the target state of the current segment;
$m_1$	Mass [kg] of the aircraft at the initial state of the current segment; and
$\gamma$	Geometric flight angle [rad] of the current segment.

Modeling of the accelerating-CAS climb stops if either the target state's calibrated airspeed is equal to the climb-out calibrated airspeed for the aircraft or the target state's altitude is equal to or greater than 10,000 ft ARE.

### 3.7.7.2 Constant-CAS Climb to Mach Transition Altitude

The constant-CAS climb to the Mach transition altitude is segmented based on 1,000-foot increments of altitude. The climb continues until either a 10,000 ft ARE target state is reached, the aircraft-specific Maximum climb-out Mach number is reached (the constant-CAS climb experiences an increasing Mach number), or the climb reaches the aircraft's Mach transition altitude.

#### 3.7.7.2.1 Calculate Speeds

Using the calibrated airspeed of the target state (which is equal to that of the initial state) and a weather reading sampled at the geographic location and time of the initial state of the current segment and the MSL altitude of the target state (which is 1,000 ft greater than that of the initial state), estimates are generated for the true airspeed, Mach number, and groundspeed.

The energy share at the target state is determined by Eq. 3-101 (which is the same equation used in constant-CAS climb procedure steps).

#### 3.7.7.2.2 Determine Segment Geometry

The thrust and drag at the target state are calculated using the default BADA 4 configuration that corresponds to the aerophase assigned to the target state:

$$\ell_z = h_2 - h_1, \quad \ell_{xyz} = \frac{\ell_z g_0}{\frac{(Th_2 - D_2)}{m_1} - a_{air,1}}$$

Eq. 3-123

$$\gamma = \sin^{-1} \frac{\ell_z}{\ell_{xyz}}, \quad \ell_{xy} = \ell_{xyz} \cdot \cos \gamma$$

where

$\ell_z$	Vertical displacement [m] of the current segment;
$\ell_{xyz}$	Total length [m] traversed by the aircraft in the current segment;
$\ell_{xy}$	Horizontal displacement [m] of the current segment;
$a_{air,1}$	Aircraft air-mass-based acceleration [m/s <sup>2</sup> ] at the initial state of the current segment (calculated using Eq. 3-102);
$h_2$	Altitude [m] at the target state of the current segment;
$h_1$	Altitude [m] at the initial state of the current segment;
$Th_2$	Calculated thrust (across all engines) [N] for the target state of the current segment;
$D_2$	Calculated drag [N] for the target state of the current segment;
$m_1$	Mass [kg] of the aircraft at the initial state of the current segment; and
$\gamma$	Geometric flight angle [rad] of the current segment.

### 3.7.7.3 Climb to 10K ft ARE

Calculating performance for a direct constant calibrated airspeed climb from 10,000 ft MSL to 10,000 ft ARE is performed using a similar process used to calculate performance for a constant calibrated

airspeed climb procedure step. The only significant variation between the two constant-CAS climb methodologies is the above-10,000 ft MSL climb sets aerophase of each target state using the same altitude-based methodology described in Section 3.7.7.1.3.

### 3.7.8 Thrust

BADA 4 analysis of procedure steps calculates thrust on the basis of the BADA 4 thrust model. This section defines thrust calculation behavior that is not standard to the BADA 4 thrust model.

#### 3.7.8.1 Corrected Net Thrust

BADA 4 thrust calculation methodologies yield net thrust (across all engines). The calculation of corrected net thrust per engine from BADA 4 all-engine thrust is defined as follows:

$$\left(\frac{F_n}{\delta}\right) = \frac{Th}{\delta \cdot n_{eng,B4}} \quad \text{Eq. 3-124}$$

where

$\left(\frac{F_n}{\delta}\right)$	Corrected net thrust per engine [lbf] at a performance state;
$Th$	All-engine thrust [lbf] at a performance state (calculated using BADA 4 methodologies);
$\delta$	Pressure ratio [dimensionless] at the performance state; and
$n_{eng,B4}$	Number of engines on the <u>BADA 4</u> aircraft.

The conversion of Doc 9911 corrected net thrust per engine to all-engine net thrust (for use in either TEM-based force balances or BADA 4 fuel burn calculations) is defined by the following:

$$Th = \left(\frac{F_n}{\delta}\right) \cdot \delta \cdot n_{eng,ANP} \quad \text{Eq. 3-125}$$

where

$n_{eng,ANP}$	Number of engines on the <u>ANP</u> aircraft.
---------------	---

#### 3.7.8.2 Noise Thrust

It is possible for descent-style procedure steps that use the Total Energy Model based equations to calculate thrust that yields negative thrust values. Under such circumstances, negative thrust values represent the situation where the drag experienced by the aircraft is higher than the thrust being produced by the aircraft's engines.

In order to preserve the negative thrust values that yield insight into the aircraft's aerodynamic state but also provide thrust values that are useful to the acoustics module, BADA 4 analysis of procedure-driven operations persists both the potentially-negative thrust values (as corrected net thrust) calculated during performance calculations as well as a version of same value of corrected net thrust that is capped at 1 pound-force in the event that the calculated thrust is less than the cap value. This capped value of thrust is persisted in performance results as noise thrust.

#### 3.7.8.3 Takeoff Thrust Transition

ICAO Doc 9911 provides a recommendation that the abrupt change from takeoff to climb thrust that occurs in departures from the runway be modeled instead as a gradual transition over 1,000 ft of

horizontal aircraft travel distance. Figure 3-17 schematically represents the insertion of a thrust transition state in between two performance states. A takeoff thrust transition segment is inserted within the first segment to switch to from takeoff to climb thrust. State 1 represents the last computed performance state to use a takeoff thrust rating while state 2 represents the first computed performance state to use a climb thrust rating. A thrust transition state is added in order to model a more gradual reduction in thrust. The track distance  $s_t$  represents the track (horizontal) distance from state 1 to the thrust transition state while  $s_2$  represents the track distance from state 1 to state 2.

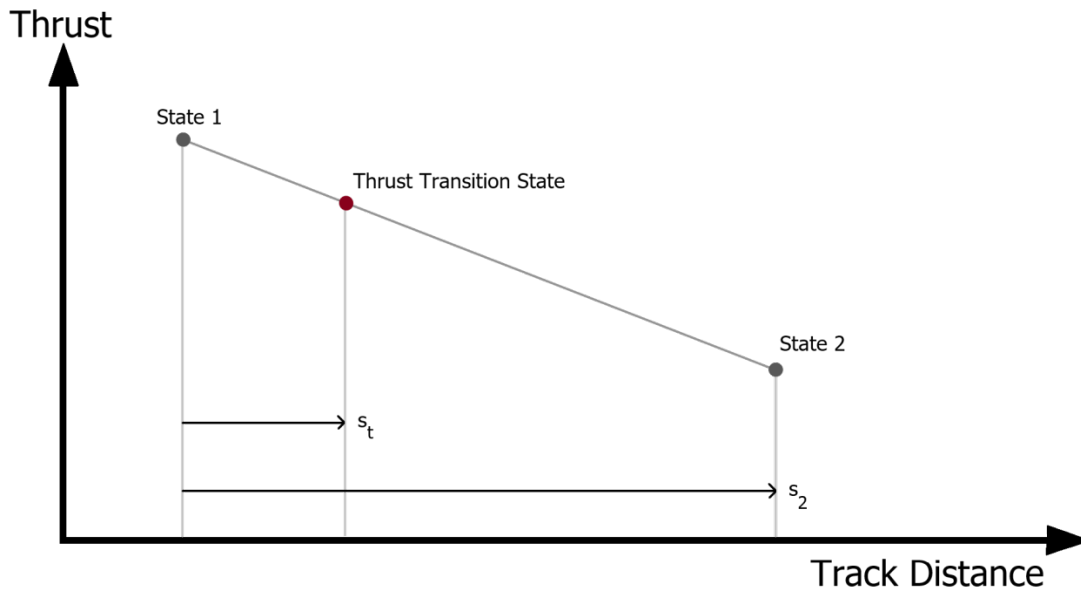

Figure 3-17 Illustration of Takeoff Thrust Transition Segment Insertion

The thrust transition state's performance values (e.g., speeds, thrust, fuel flow) are calculated as linear interpolations of the two calculated performance states that bound it. The exact distance ahead of the lower bound performance state (state 1 in Figure 3-17) at which to place the thrust transition state is determined by the following equation:

$$s_t = \min\left(\frac{s_2}{2}, 1,000 \text{ ft.}\right) \quad \text{Eq. 3-126}$$

where

- $s_t$  Distance [ft.] from state 1 to the thrust transition state; and
- $s_2$  Distance [ft.] from state 1 to state 2.

#### 3.7.8.4 Takeoff & Climb Thrust

Under circumstances where an aircraft is flying at an excessively low Mach number or where data gaps exist for specific thrust ratings, the calculation of thrust in the BADA 4 analysis of procedure steps follows the process outlined in this section.

Takeoff procedure steps (which always request takeoff thrust type) are modeled with ANP jet thrust coefficients and not with BADA 4 thrust ratings (takeoff or otherwise).

For BADA 4 jet aircraft without takeoff rating data, procedure steps that request a takeoff thrust rating are modeled using their respective ANP jet thrust coefficients.

For step types that request one of the climb thrust types, the BADA 4 climb rating is used for thrust calculations.

### 3.7.8.5 *Landing-Decelerate Thrust*

The BADA 4 analysis of landing-decelerate procedure steps uses the percent-of-static thrust model (based on the static thrust of the ANP airplane) available for use by that procedure step type. Landing-decelerate procedure steps use reverse-thrust to assist in decelerating the aircraft on the runway because a reverse-thrust thrust setting is not available in the BADA 4 thrust model.

A reverse-thrust landing-decelerate procedure step models thrust for all but the first performance state on the runway (i.e., the touch-down point) for arrival procedure profiles.

### 3.7.8.6 *Reduced Departure Thrust*

#### 3.7.8.6.1 Introduction

The current section focuses on the reduced thrust implementation in the BADA 4 domain. Specific details are not given, because the BADA 4 data and methods are proprietary to EUROCONTROL. In addition, the related minimum thrust level methodology and the reduced-thrust to full-thrust taper mechanism are covered.

Official BADA 4 modeling methods is described in detail in the BADA 4 User Manual<sup>14</sup>. A general discussion of the BADA 4 data and methods is provided in Section 12 Appendix – BADA 4 Model. Note that the BADA 4 temperature-dependent engine performance is modeled slightly differently than the description given below; to maintain EUROCONTROL's proprietary interests, the details have been changed slightly and made more generic.

#### 3.7.8.6.2 Minimum Thrust Level Methodology

Turbofan engine behavior depends on whether they are operated above or below a known temperature called the breakpoint temperature,  $\Delta T_{break}$ , which defines two respective operation areas: the flat-rated area, and the temperature-rated area.

The engine performance in the flat-rated area does not directly depend on the temperature, and can be expressed as a function of the Mach number,  $M$ , and the local atmospheric conditions (other than temperature).

The engine performance in the temperature-rated area *does* directly depend on the temperature, and can be expressed as a function of the Mach number,  $M$ , and the local atmospheric conditions, including the temperature.

Direct implementation of the BADA 4 temperature methods as documented in ref 1 can lead to unrealistic increases in the modeled thrust at the break point temperature, particularly when modeling

operations at periods with higher than normal atmospheric pressure. To avoid this behavior, BADA 4 analysis of procedures utilizes a so-called minimum thrust level methodology. At temperatures below the breakpoint, the standard flat-rated BADA 4 thrust modeling methodology is used. At temperature above the breakpoint, the thrust is calculated using both the flat- and temperature-rated methods, and the thrust is set to the minimum of these two values:

$$F = \begin{cases} F_{flat}, & T \leq \Delta T_{break} \\ \min(F_{temp}, F_{flat}), & T > \Delta T_{break} \end{cases} \quad \text{Eq. 3-127}$$

### 3.7.8.6.3 Departure Thrust Taper

For BADA 4 analysis of procedure steps that call for a reduced thrust setting, the flat-rated BADA 4 thrust coefficient is scaled by the thrust reduction that corresponds to the procedure step's thrust type, and the thrust coefficients for both the full thrust and the reduced thrust conditions become:

$$F_{reduced} = k_{reduced} \cdot F_{flat} \quad \text{Eq. 3-128}$$

where the reduction coefficient,  $k_{reduced}$  is specified as follows:

$$k_{reduced} = \begin{cases} 1.00, & \text{full thrust} \\ 0.95, & 5\% \text{ reduced takeoff} \\ 0.90, & 10\% \text{ reduced takeoff} \\ 0.90, & 10\% \text{ reduced climb} \\ 0.85, & 15\% \text{ reduced takeoff} \end{cases} \quad \text{Eq. 3-129}$$

The respective temperature-rated thrust is not affected by the reduced thrust conditions.

At altitudes higher than 10,000 feet MSL, the engine thrust is increased to the BADA 4 climb thrust. To avoid an unrealistic instantaneous jump from the reduced thrust setting to the un-reduced BADA 4 thrust, BADA 4 analysis of procedures uses a process referred to as fast taper. The lower taper level,  $H_1$  is fixed at 10,000 feet MSL, whereas the upper taper limit,  $H_2$ , is adjustable through the AEDT user interface. The upper taper limit has a default setting of 12,000 feet MSL. This allows the engine to gradually change the thrust from the reduced thrust setting at the lower taper level to un-reduced BADA 4 climb thrust setting at the upper taper level. The taper coefficient,  $k_{taper}$ , at altitude  $h$  MSL, is defined as follows:

$$k_{taper} = \begin{cases} 0, & h < H_1 \\ \frac{h - H_1}{H_2 - H_1}, & H_1 \leq h \leq H_2 \\ 1, & h > H_2 \end{cases} \quad \text{Eq. 3-130}$$

The equation for the flat area thrust, which takes into account both the reduced thrust and taper conditions, reads as follows:

$$F_{flat,taper} = [k_{reduced} + (1 - k_{reduced}) \cdot k_{taper}] \cdot F_{flat} \quad \text{Eq. 3-131}$$

Figure 3-18 demonstrates the transition from the reduced thrust to the full thrust engine setting for two different taper upper limits,  $H_2 = 12,000$  feet, and  $H_2 = 14,000$  feet, using an example aircraft modeled with BADA 4. The data labeled “no taper” correspond to the condition  $H_2 = H_1 = 10,000$  feet.

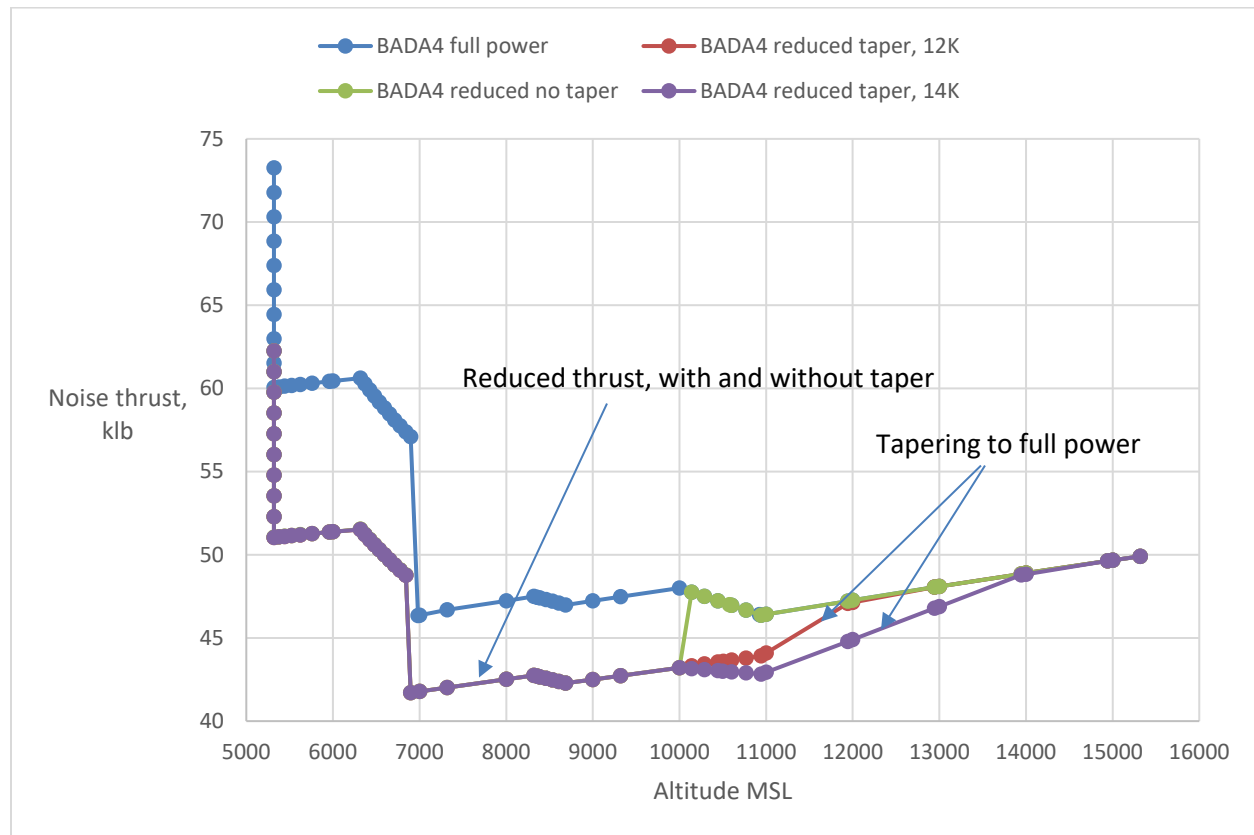

Figure 3-18 Reduced Thrust to Full Thrust Transition

#### 3.7.8.6.4 Summary

In the procedural BADA 4 workflow of AEDT, the BADA 4 thrust is calculated using the minimum thrust level methodology, (Eq. 3-127). The BADA 4 flat rated thrust is subjected to thrust reduction that corresponds to the procedure step’s thrust type, and the reduced thrust to full thrust taper mechanism (Eq. 3-131) is used if selected by the user.

#### 3.7.9 Drag

AEDT uses the BADA 4 drag model for procedure-driven operations. The BADA 4 drag model is discussed in the Section 12 Appendix – BADA 4 Model. The discussion is relatively high level due to the proprietary nature of the BADA 4 methods.

Independent of the drag model used to calculate the aircraft performance state’s drag coefficient, the calculation of drag force is given by:

$$D = C_D \frac{1}{2} \rho V_{TAS}^2 S \quad \text{Eq. 3-132}$$

where

$\rho$	Local density [kg/m <sup>3</sup> ];
$S$	Aircraft-specific wing reference area [m <sup>2</sup> ];
$V_{TAS}$	Local aircraft true airspeed [m/s]; and
$C_D$	Aircraft drag coefficient [dimensionless].

The BADA 4 drag models utilize the aircraft's lift coefficient at a performance state in order to calculate that particular state's drag coefficient. The lift coefficient ( $C_L$ ) and the lift force ( $L$ ) are calculated as follows:

$$C_L = \frac{2mg_0}{\rho V_{TAS}^2 S \cos \theta} \quad \text{Eq. 3-133}$$

$$L = C_L \frac{1}{2} \rho V_{TAS}^2 S \quad \text{Eq. 3-134}$$

where

$m$	Current aircraft mass [kg];
$\rho$	The observed local air density [kg/m <sup>3</sup> ];
$V_{TAS}$	Local aircraft true airspeed [m/s];
$S$	BADA 4 aircraft wing reference area [m <sup>2</sup> ]; and
$\theta$	Aircraft bank angle [rad].

### 3.7.9.1 Clean Drag Model

The clean drag model is used when calculating drag for an aircraft performance state whenever the performance state is set to use a BADA 4 configuration where the landing gear and all high-lift devices are retracted. The performance state's drag coefficient is calculated using BADA 4 clean-configuration drag-modeling equations which are generally dependent on aircraft Mach number.

### 3.7.9.2 Non-Clean Drag Model

The non-clean drag model is used whenever an aircraft is in a BADA 4 configuration with a high-lift device deployed (landing gear are never deployed unless a high-lift is also deployed). In such situations, the aircraft's drag coefficient is calculated using the BADA 4 non-clean configuration drag model, which depends in part on the lift coefficient.

### 3.7.10 Fuel Flow

The BADA 4 analysis of procedure profiles uses the BADA 4 fuel model (which uses thrust as an input) in order to calculate the fuel flow through aircraft engines.

When BADA 4 thrust data are used in the model, BADA 4 fuel data are also used. When BADA 4 thrust data are not available, AEDT reverts to using, sequentially, either the SFI, BADA 3, or BFFM2 fuel consumption methods, depending on the first available source of data.

Table 3-8 provides an outline on how the thrust calculated for a procedure step is ferried for use to the appropriate fuel flow model. This table provides an overview of how thrust calculated for a procedure



step is ultimately used within one of the fuel flow models. For the sake of brevity, reduced versions of takeoff and climb thrusts are omitted from explicit listing (their existence is implied by the listing of their maximum rating versions).

Table 3-8 Summary of the Thrust Model Used to Calculate Fuel Flow/Burn for Each Procedure Step Type in BADA 4 Workflows

Step Type	Thrust Type	Thrust Model*	Thrust Coefficient/ TSFC for Fuel Flow	Fuel Flow Model
Takeoff (T)	T	Doc 9911 (T)	SFI or BADA 3 TSFC	SFI, BADA 3, or BFFM2
Climb (C)	T	BADA 4 (MTKF rating) or Doc 9911 (T)	BADA 4 rated thrust → BADA 4 C <sub>T</sub> or SFI or BADA 3 TSFC	BADA 4 (non-idle fuel) or SFI, BADA 3, or BFFM2
	C	BADA 4 (MCMB rating)	BADA 4 rated thrust → BADA 4 C <sub>T</sub>	BADA 4 (non-idle fuel)
Accelerate (A, P)	T	BADA 4 (MTKF rating) or Doc 9911 (T)	BADA 4 rated thrust or Doc 9911 thrust → BADA 4 C <sub>T</sub>	BADA 4 (non-idle fuel)
	C	BADA 4 (MCMB rating)	BADA 4 rated thrust → BADA 4 C <sub>T</sub>	BADA 4 (non-idle fuel)
Descend (D)	N/A	BADA 4 (TEM-based)	BADA 4 non-rated thrust → BADA 4 C <sub>T</sub>	BADA 4 (non-idle fuel)
Descend-Idle (F)	N/A	BADA 4 (LIDL rating)	BADA 4 rated thrust → BADA 4 C <sub>T</sub>	BADA 4 (idle fuel)
Descend-Decelerate (E)	N/A	BADA 4 (TEM-based)	BADA 4 non-rated thrust → BADA 4 C <sub>T</sub>	BADA 4 (non-idle fuel)
Level (V)	N/A	BADA 4 (TEM-based)	BADA 4 non-rated thrust → BADA 4 C <sub>T</sub>	BADA 4 (non-idle fuel)
	T	BADA 4 (MTKF rating) or Doc 9911 (T)	BADA 4 rated thrust or Doc 9911 thrust → BADA 4 C <sub>T</sub>	BADA 4 (non-idle fuel)
Level-Idle (W)	N/A	BADA 4 (LIDL rating)	BADA 4 rated thrust → BADA 4 C <sub>T</sub>	BADA 4 (idle fuel)
Level-Decelerate (U)	N/A	BADA 4 (TEM-based)	BADA 4 non-rated thrust → BADA 4 C <sub>T</sub>	BADA 4 (non-idle fuel)
Landing-Decelerate (B)	V, L	Doc 9911 (Percent Static)	Non-BADA 4 SFI or BADA 3 TSFC	SFI, BADA 3, or BFFM2

\* Maximum take-off (MTKF), Maximum climb (MCMB), Total Energy Model (TEM), Low idle (LIDL)

For non-procedure step behavior that occurs above 10,000 ft MSL, BADA 4 thrust ratings are used to calculate thrust at all performance states. Therefore, an unmodified version of the BADA 4 fuel flow methodology is used to calculate fuel burn for performance states above 10,000 ft MSL. Table 3-9 provides an overview of how thrust calculated for above-10K MSL procedure-driven content is ultimately used within one of the BADA 4 fuel flow models. For the sake of brevity, reduced versions of takeoff and climb thrusts are omitted from explicit listing (their existing is implied by the listing of their maximum rating versions).

Table 3-9 Summary of the Thrust Model Used to Calculate BADA 4 Fuel Flow/Burn for Non-Procedure-Step for Profile-Driven Operations

Segment Behavior	Thrust Model*	Thrust Coefficient for Fuel Flow	Fuel Flow Model
Accelerate to Climb-Out CAS	BADA 4 MTKF or MCMB or MCRZ rating	BADA 4 rated thrust → BADA 4 C <sub>T</sub>	BADA 4 (non-idle fuel)
Constant-CAS Climb to Mach Transition Altitude	BADA 4 MTKF or MCMB or MCRZ	BADA 4 rated thrust → BADA 4 C <sub>T</sub>	BADA 4 (non-idle fuel)
Constant-CAS Climb from 10K MSL to 10K ARE	BADA 4 MTKF or MCMB or MCRZ	BADA 4 rated thrust → BADA 4 C <sub>T</sub>	BADA 4 (non-idle fuel)

\* Maximum take-off (MTKF), Maximum climb (MCMB), Maximum cruise (MCRZ)

The BADA 4 fuel flow model yields a fuel flow rate across all engines. From this, the total fuel burned for each performance state is determined from the following relation.

$$F = f \cdot t_{dur} \tag{Eq. 3-135}$$

where

- F* Total fuel burned [lb.] for the segment;
- f* Fuel flow rate [lb./s] across all aircraft engines; and
- t<sub>dur</sub>* Segment duration [s].

The fuel burned by an aircraft during a performance segment decrements the aircraft’s weight. The mass of the aircraft at the end of the segment is equal to mass at the start of the segment minus mass of the fuel burned during the segment.

### 3.7.11 Noise Operation Mode

The noise operation mode assigned to computed performance states determines the ANP NPD curves (approach or departure) to use in acoustics computations. BADA 4 analysis of procedure-driven operations assigns noise operation mode to each performance state during procedure step computations based on the procedure step type or behavior. Table 3-10 summarizes the default noise operation mode assignments to procedure profile computed performance states.

Table 3-10 Default Noise Operation Mode Assignments During Procedure Profile Computations

Procedure Step	Default Noise Operation Mode
Takeoff	Departure
Constant-CAS Climb	
Accelerate (Climb-Rate & Percent)	
Constant-CAS Climb (10K MSL to 10K ARE)	
Increasing CAS Climb (to Climb-Out CAS)	
Constant-CAS Climb (to Mach Transition Altitude)	
Level	Approach or Departure
Descent (including Idle & Decelerate)	Approach
Level-Idle & Level-Decelerate	

Procedure Step	Default Noise Operation Mode
Landing	
Landing Decelerate	

Interpolated performance states receive the noise operation mode assignment of the lower-bound performance state from which they are developed.

A noise operation mode re-assignment algorithm potentially modifies the default noise operation mode assigned to a performance state after a complete trajectory has been developed for the profile-driven operation. The algorithm re-assigns noise operation mode to departure for all approach operation performance states that are at or above 10,000 ft above airport elevation. The algorithm also reassigns noise operation mode to approach for all operation performance states that define the initial performance state of a segment that neither appreciably climbs nor noticeably accelerates (in groundspeed). The tolerance for climbing is set at 0.1 ft. The tolerance for noticeable acceleration is 0.1 knots.

### 3.8 Differences between Doc 9911 and BADA 4 Analysis of Terminal-Area Procedures

This section provides a summarized list of differences of the fundamental assumptions as well as the practical implementation details between the BADA 4 analysis of procedure-driven profiles and its Doc 9911 counterpart.

#### 3.8.1 Physics Models

The Doc 9911 analysis of procedure-driven operations uses a balance of forces acting on an aircraft in order to model aircraft flight kinetics. The general form of the force-balance is provided in ICAO Doc 9911<sup>67</sup> as equation C-20 and updated to include bank angle, and is defined as:

$$\left(\frac{F_n}{\delta}\right) = W \cdot \frac{R \cdot \frac{\cos \gamma}{\cos \varepsilon} + \sin \gamma + a/g_0}{N \cdot \delta} \quad \text{Eq. 3-136}$$

where

$\left(\frac{F_n}{\delta}\right)$	Aircraft corrected net thrust per engine at current state;
$W$	Current aircraft weight;
$R$	Ratio of aircraft's current drag coefficient to its current lift coefficient;
$\gamma$	Climb angle of the current aircraft segment;
$\varepsilon$	Bank angle of the current aircraft segment;
$a$	Aircraft's air-mass-based acceleration in the direction of motion;
$g_0$	Gravitational acceleration constant;
$\delta$	Air pressure ratio at current aircraft location; and
$N$	Number of engines on aircraft.

The BADA 4 analysis of procedure-driven operations equates the work done by forces acting on the aircraft to the rate at which the aircraft's energy (both kinetic and gravitational potential) changes. This

model (which is common to both BADA Family 3 and 4) is termed the Total-Energy Model (TEM) and is expressed by the following:

$$(Th - D) \cdot v_{TAS} = m \cdot g_0 \cdot \frac{dh}{dt} + m \cdot v_{TAS} \cdot \frac{dv_{TAS}}{dt} \quad \text{Eq. 3-137}$$

where

$Th$	Aircraft thrust (summed across all engines) (N);
$D$	Aircraft drag (N);
$v_{TAS}$	Aircraft true airspeed (m/s);
$m$	Aircraft mass (kg);
$g_0$	Gravitational acceleration constant (m/s <sup>2</sup> );
$\frac{dh}{dt}$	Rate of change of the aircraft's altitude (m/s); and
$\frac{dv_{TAS}}{dt}$	Rate of change of the aircraft's true airspeed (m/s <sup>2</sup> ).

While the Doc 9911 force balance and the BADA TEM describe the same physical phenomenon of aircraft flight, their differing fundamental assumptions as well as the data sources with which they are combined are expected to lead to differences in modeled aircraft performance.

### 3.8.2 Fuel Burn Models

The following air operations can be modeled in AEDT using BADA Family 4 performance model: procedural terminal area operations, including operations with speed and altitude controls; sensor path runway-to-runway operations; the Official Airline Guide (OAG) airport-to-airport operations otherwise known as CAEP operations.

In the course of the BADA Family 4 performance modeling, the respective BADA Family 4 fuel calculations are activated under the following conditions:

When the aircraft is airborne, traveling at a speed greater than Mach 0.25 (approximately 165 KCAS), and one of the following conditions is true:

- Aircraft is at or above 1,500 feet AFE.
- Aircraft is below 1,500 feet AFE, flight segment thrust type is defined and corresponds to one of the takeoff thrust types, and BADA 4 MaxTakeoff data are available.
- Aircraft is below 1,500 feet AFE, flight segment thrust type is not defined, segment trajectory mode is TakeoffAirborne, and BADA 4 MaxTakeoff data are available.
- Aircraft is below 1,500 feet AFE, flight segment thrust type is defined and corresponds to one of the climb thrust types, and BADA 4 MaxClimb data are available.
- Aircraft is below 1,500 feet AFE, flight segment thrust type is not defined, segment trajectory mode is TerminalClimb, and BADA 4 MaxClimb data are available.

Notes:

- The BADA 4 MaxTakeoff and MaxClimb data are not used as part of the fuel burn calculation. However, the condition on these data is needed as an indication that the BADA 4 fuel burn model is calibrated for use with the respective airborne segments.
- In the use case of the BADA Family 4 modeling with altitude and speed controls, the BADA Family 4 fuel calculations are activated as the post process after the aircraft performance modeling is complete, and performance result is constructed for the usage by other AEDT modules.

When the aircraft is operating below the above speed and altitude constraints, the Senzig-Fleming-lovinelli (SFI) fuel flow model is used for aircraft with thrust-specific fuel consumption (TSFC) coefficients and the BADA Family 3 fuel flow model is used otherwise. In addition, the latter two fuel model are used as appropriate in the use case of the terminal area operations with fixed point profiles, which are modeled using unified performance modeling neutral algorithm.

BFFM2, EEDB or other published engine data fuel models are used for the fuel calculations of the taxi flight segments, and for in-flight cases where no other fuel model data exists.

### 3.8.3 General Differences in Implementation of Procedure Step Modeling

A key difference between AEDT's BADA 4 and Doc 9911 modeling of procedure steps is in the number of performance states implicitly generated per each procedure step.

In AEDT's implementation of procedure step modeling per Doc 9911 guidelines, each procedure step generates one initial state and one final state. Modeling of the subsequent procedure step also generates one initial state and one final state. The modeling of these two consecutive steps results in the two coincident performance states. The first step's final state and the second step's initial state are located at the same location. Furthermore, the atmospheric parameters used by the initial state and final state of a procedure step are identical (i.e., weather is held constant throughout a procedure step).

AEDT's implementation of BADA 4 -based procedure step modeling does not generate coincident procedure step states. Each procedure step (except the first one within a procedure profile) does not generate its own initial performance state. The initial performance state of a step is generated as the final state of the previous step. Even though the initial state of the current procedure step was generated as the final state of the previous step, the current step may update some of the properties (e.g., thrust) of the initial state.

Generally, one of the coincident states produced in the Doc 9911 analysis of procedure step is removed. When the previous step's final state's thrust and groundspeed are equal to those of the next step's initial state, the previous step's final state is kept while its corresponding coincident state (the next step's initial state) is removed. When the previous step's final state's thrust or groundspeed differ from those of the next step's initial state values (and the step transitions from either a level or descend step to either a level or descend step), then the previous step's initial state is removed.

A significant consequence occurs when the previous step's final state's thrust or groundspeed differ from those of the next step's initial state values and the step transition is not between descend or level steps. In that situation, both the previous step's final state and the next step's initial state are kept. The location of the next step's initial state is shifted forward by 1,000-feet in track-wise distance. The speed and altitude properties of the shifted state are maintained.

The behavior of maintaining of both coincident points (but shifting one of them) is meant to capture and model the real-world aerodynamic effects of aircraft transitioning between descend-idle and level-idle steps. The changing aircraft flight dynamics that occur between descend-idle and level-idle steps (which may include aircraft flap transitions) often lead to large divergences in the thrust modeled by each respective step. AEDT's Doc 9911 analysis of procedure steps will therefore model slightly more gradual versions of the discrepant thrust that is calculated at the interface of level-idle and descend-idle procedure steps. Since the BADA 4 analysis does not produce coincident performance states at the boundary of two procedure steps, discernable differences in speed and thrust can be expected to occur at the transition from certain step types to another.

#### **3.8.4 Aircraft Banking Effects**

The Doc 9911 analysis of procedure profile operations models the effects of aircraft banking as a post-process after an entire set performance states have been developed for a procedure profile. The application of banking effects serves to increase thrust for performance states that are either not climbing or have the approach noise operation mode assignment (or both). If the performance state has the departure operation mode or is climbing, then banking effects are used to modify the geometry as well as speeds of the computed performance states of the procedural profile.

The BADA 4 analysis of procedure profiles does not model the effects of aircraft banking either through direct use of bank angle in BADA 4 performance equations nor as a post-process application of banking effects.

#### **3.8.5 Calibrated Airspeed & Altitude-Based Segmentation**

As elaborated in the description of the methodologies of calculating performance for each procedure step type, the BADA 4 analysis of procedure profile computations segments the computation of performance states for procedure steps by calibrated airspeed (for step types for which a significant change in speed is typical) or by altitude (for step types for which a significant change in altitude is typical). The calibrated airspeed is given in the AEDT user interface in knots, while the internal calculations are performed using meters per second. Similarly, the altitude – usually ARE – is accepted as feet in the AEDT user interface, while the calculations use meters.

Aircraft performance for certain procedure step types is not modeled directly from a step's initial state or the step's final state, rather, performance is segmented such that a step is modeled with the aircraft reaching a series of targets. The value (i.e., ARE altitude or calibrated airspeed) of the targets follows a progression until the final target of the step is reached.

For typical procedure profiles, performance results computed for a procedure profile aircraft operation modeled with the BADA 4-based methodology will yield a higher level of detail than the same operation modeled with the Doc 9911 methodology. A summary of the style of segmentation performed for each step type is outlined in Table 3-11. All steps for which performance is calculated are modeled such that each step is modeled not as a single segment, but rather as a series of segments. This methodology captures a more detailed modeling of steps for which aircraft altitude or CAS changes significantly.

Table 3-11 Style of Segmentation for Each Procedure Step Type (or Above-Step Type Behavior) in the BADA 4 Analysis of Procedure Profiles

Step Type (or Behavior)	Segmentation Style
Takeoff	CAS
Constant-CAS Climb	Altitude
Acceleration (Climb-Rate or Percent)	CAS
Constant-CAS Climb (from 10K MSL to 10K ARE)	Altitude
Accelerating CAS-Climb (to Climb-Out CAS)	CAS
Constant CAS Climb (to Mach Trans. Alt.)	Altitude
Descend	Altitude
Descend-Idle	Altitude
Descend-Decelerate	Altitude
Level	<b>N/A</b>
Level-Idle	CAS
Level-Decelerate	CAS
Landing	<b>N/A</b>
Landing-Decelerate	CAS

### 3.8.6 Doc 9911 Thrust Transitions

The modeling of takeoff-to-climb thrust transitions (described in Section 3.7.8.3) is expected to produce slightly different results between a procedure operation modeled with the Doc 9911 analysis and its counterpart modeled with the BADA 4 methodology due specifically to the step segmentation behavior described in the previous Section 3.8.5.

The thrust transition modeling performed in the Doc 9911 analysis of procedure profiles deals with a transition state modeled between two performance states that define the initial and final state of a procedure step. A typical system-defined procedure profile that includes a takeoff-to-climb thrust transition will usually result in the two bounding performance states (between which the thrust transition state is inserted) to be more than 2,000 feet in track-wise distance apart. An inspection of Eq. 3-126 demonstrates that this situation will result in a thrust transition segment that is exactly 1,000 feet in track-wise length.

AEDT allows aircraft to accelerate beyond 250 knots calibrated airspeed once they reach an altitude of 10,000 feet MSL when modeling flight performance using the Doc 9911 analysis.

Because the BADA 4 analysis of procedure profiles segments procedure steps based on either ARE altitude or CAS as well as inserts interpolated performance states at input ground track point locations, the bounding performance states between which a thrust transition state is inserted are not necessarily more than 2,000 feet in track-wise distance apart. This results in a higher likelihood that a thrust transition state is less than 1,000 feet in length.

### 3.8.7 Aircraft Weight in Procedure Profile Computations

While the Doc 9911 modeling of procedural profiles calculates a continuously-decreasing aircraft weight (due to fuel burn), the actual value of decremented weight is not used within procedure step calculations that make use of aircraft weight (e.g., takeoff, accelerate steps). The weight used in such calculations is the initial profile weight.

The BADA 4 analysis of procedural profiles always uses the current aircraft weight to calculate performance quantities for steps that make use of aircraft weight.

### 3.8.8 Projected vs. Geographic Coordinate System

The Doc 9911 modeling of procedural profiles performs all track-based computations in a 2-dimensional projected coordinate system. Input ground track points (which are specified in a geographic coordinate system) are projected onto a 2-dimensional plane whose origin osculates the airport's geographic location.

The BADA 4 analysis of procedural profiles maintains all ground track-based modeling in a geographic coordinate system. Because of this, differences in the length of a modeled ground track exist between the two modeling methodologies. While the differences are expected to be small in magnitude for tracks of length necessary to model a typical procedure profile, the differences between track lengths are expected to increase as the geographic span of the track increases.

### 3.8.9 Speed Conversions

The Doc 9911 analysis of procedural profiles uses the equation specified by Doc 9911 to convert between true and calibrated airspeed:

$$v_{TAS} = \frac{v_{CAS}}{\sqrt{\sigma}}, \sigma = \frac{\rho}{\rho_0} \quad \text{Eq. 3-138}$$

where

$v_{TAS}$	Aircraft true airspeed;
$v_{CAS}$	Aircraft calibrated airspeed;
$\sigma$	Air density ratio [dimensionless];
$\rho$	Air density at current aircraft location; and
$\rho_0$	Air density at ISA sea-level conditions.

The BADA 4 analysis of procedural profiles uses the equation specified by BADA (common to Family 3 and 4) to convert between true and calibrated airspeed described by Eq. 3-91 and Eq. 3-92. Eq. 3-138



above is a simplified version of the full BADA equation; this simplified version is sufficiently accurate when the air flow around the aircraft can be adequately described by incompressible fluid dynamics. The conditions for assuming incompressible flow exist in the terminal regions of aircraft operations due to the relatively slow aircraft speeds. For the higher speed, compressible flow operations which exist in the en-route portions of an operation, the full BADA translation must be used to retain adequate accuracy.

### 3.8.10 Wind Direction Aligned with Runway

Runways are typically used with the air mass moving against the runway direction (i.e., aircraft flying into a headwind), and the wind direction is nominally stable over the time-scales of takeoff and climb-out or descent and approach.

For both Doc 9911 and BADA 4 analysis, AEDT uses a headwind with magnitude 8 knots when using ISA weather; or a headwind with the airport's ten-year annual-average wind magnitude when using airport-based weather. If an airport's weather has no wind magnitude, then 8 knots is used.

When the wind direction is provided (i.e., when using high-fidelity weather or emissions dispersion weather), aircraft performance analysis by either model accounts for the angle between aircraft course and wind direction.

When the wind direction is unknown (i.e., when using ISA weather or airport weather), it is handled differently for BADA 4 analysis vs. Doc 9911 analysis.

- For BADA 4 analysis, the wind direction is aligned with the runway and opposite of the runway direction, i.e., headwind direction of aircraft movement, for operations with which a runway is associated.
  - For arrival, departure, touch-and-go, and circuit operations, the wind direction persists throughout the operation (irrespective of altitude or aircraft course). That is, the wind direction is always aligned with the runway.
  - For gate-to-gate or runway-to-runway operations, the headwind persists during the entire operation.
  - For overflight operations, wind is always directed against the aircraft course. This is done because wind direction is ambiguous for overflights; directing wind against the course introduces a “conservative bias”, which is favored over “no bias”.
- For Doc 9911 analysis, the headwind persists during the entire operation. That is, wind direction changes such that it is always directed against aircraft course.

### 3.8.11 Initial Departure Takeoff Thrust

The Doc 9911 analysis of the procedural profiles uses a calibrated airspeed equal to zero to compute the corrected net thrust at the start of ground roll for takeoff steps used in a departure procedure profile. The BADA 4 analysis of takeoff steps always uses the calibrated airspeed computed at the start of ground roll. Slight differences in the corrected net thrust at the start of a departure's takeoff ground roll are expected upon a close comparison of such results.

### 3.8.12 Takeoff Ground Roll Step Splitting

The Doc 9911 analysis of the procedure profiles splits a takeoff step into segments whose groundspeed increases by no more than ten knots, with each segment performance state's properties (e.g., thrust and speed) determined by linear interpolation with respect to ground roll distance. The BADA 4 analysis of takeoff steps *models* a takeoff step as a series of increasing-CAS segments whose calibrated airspeed increases by increments of five knots until the end-of-ground-roll calibrated airspeed is achieved. A slight difference in the behavior of ground-roll thrust (i.e., linear versus non-linear) is therefore expected to be observed.

### 3.8.13 Thrust Tapering

Thrust tapering is modeled only in the BADA 4 analysis of procedural operations. The Doc 9911 methodology of computing results for procedural operations does not model thrust tapering behavior.

### 3.8.14 User-Specified Thrust

User-specified thrust for the step types that allow such a definition is modeled only in the Doc 9911 analysis of procedural operations. The BADA 4 analysis does not currently support user-specified thrust in procedure step modeling.

## 3.9 Trajectory-Driven Flight Performance

Trajectory based flight performance is a subsection of aircraft performance in AEDT that allows for deviation from standard AEDT profiles and allows for additional freedom in modeling aircraft altitude characteristics in flight. It is particularly useful for modeling situations where high fidelity flight tracking data is available so that points along the aircraft's actual trajectory can be modeled.

There are two types of trajectory-based inputs that can drive flight performance in AEDT: altitude/speed controls and sensor paths. Flights driven by altitude/speed controls are discussed in Section 3.9.1. Flights driven by sensor paths are discussed in Section 3.9.2.

### 3.9.1 Track Control Flights

Track controls are one type of trajectory-based input that can drive AEDT flight performance. They allow specification of precise 3-dimensional locations (and, optionally, speeds) to be reached along the flight path. There are two types of track controls: altitude controls and speed controls.

#### 3.9.1.1 Meaning of Altitude and Speed Controls

An altitude control defines rules for what an aircraft's MSL altitude (feet) should and should not be as it passes over a particular track point. Specifically, it establishes a target altitude that an aircraft should try to reach as it passes over the track point, as well as restricted altitude ranges that the aircraft is not allowed to occupy as it passes over the track point. Note that track points are not required to have altitude controls associated with them, and only one altitude control can be assigned to a given track point.

An altitude control is composed of a target and restrictions. In AEDT, the restriction aspect of an altitude control is derived from the target aspect (that is, the bounds of restricted altitude ranges are a function of the target altitude). AEDT supports three types of altitude restrictions:

1. “At” controls restrict the aircraft from being more than 300 ft from the target altitude when passing over the track point.
2. “AtOrAbove” controls restrict the aircraft from being more than 300 ft below the target altitude when passing over the track point.
3. “AtOrBelow” controls restrict the aircraft from being more than 300 ft above the target altitude when passing over the track point.

The three different restriction types are illustrated in Figure 3-19. This figure also illustrates that the 300ft buffers described above function as “tolerances” within which aircraft can miss target altitudes without entering restricted altitude ranges. Note that this tolerance of 300ft is fixed in AEDT, and cannot be changed by the user.

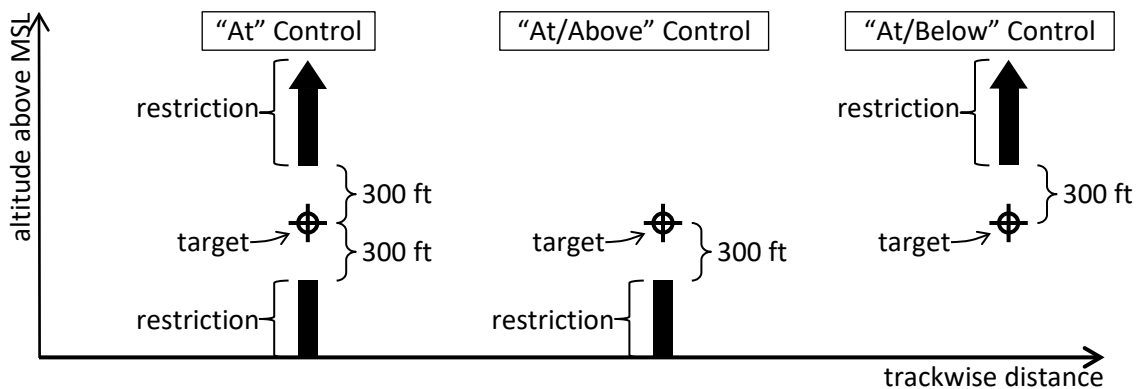

Figure 3-19 Altitude Controls

A speed control is conceptually similar to an altitude control, except that it describes targets and restrictions on speed rather than altitude. The tolerance associated with speed controls is 20 knots.

### 3.9.1.2 Track Control Input Requirements and Interpretations

Additional notes about track controls include:

1. Altitude controls specifying altitudes below 500 ft AFE are ignored by AEDT. That is, assigning a control targeting an altitude below 500 ft AFE is equivalent to assigning no control at all; no targets or restrictions are applied to aircraft altitude at the associated geographic location.
2. Track controls on the first point in a departure track (corresponding to the beginning of takeoff ground roll) are ignored by AEDT.
3. In an approach track, any control assigned to the last defined point (which corresponds to the runway end near where the aircraft lands) is ignored by AEDT.
4. An aircraft must have procedural profiles in order to be used with a track that includes altitude controls. An error is generated during performance processing if this rule is violated.
5. Overflight tracks containing altitude controls must have a minimum of two altitude controls above 500 ft AFE. An error is generated during performance processing if this rule is violated.
6. Approach tracks cannot have sequentially ascending altitude control targets.
7. Departure tracks cannot have sequentially descending altitude control targets.
8. Altitude controls of type AtOrBelow are interpreted during performance processing as though their target altitude is the lesser of their given target altitude and the aircraft’s maximum BADA 3 operating altitude. This interpretation is illustrated in Figure 3-20. Note that this is done

whether the specified target is in the terminal area or en-route. Also note that there are no analogous treatments for the other control types.

9. Doc 9911/BADA 3 analysis of flights on controlled tracks ignores speed controls.
10. All speed controls on a track are ignored if there are no altitude controls on the track.

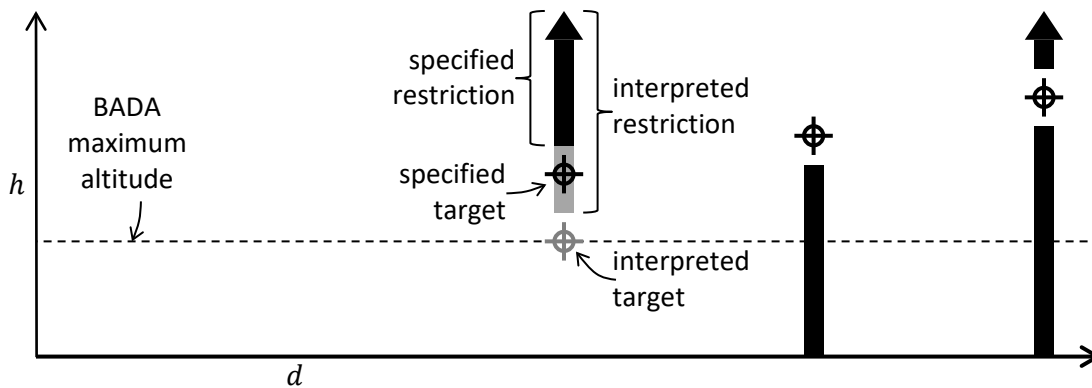

Figure 3-20 Effect of BADA 3 Maximum Altitude on Interpretation of “AtOrBelow” Controls

The observed altitude and speed controls provide a discrete set of MSL altitude and KCAS targets. However, they are interpreted to comprise continuous target profiles for altitude and speed. These target profiles vary linearly along the track between controlled track points.

### 3.9.1.3 Conceptual Overview of Analysis

AEDT calculates trajectories to match MSL altitude (feet) control targets as closely as possible, within the limits of the given aircraft’s performance characteristics, and in the context of the defined atmospheric conditions. When a control’s altitude restrictions are violated due to aircraft performance limitations, AEDT issues an error message, and the flight’s trajectory is discarded and excluded from environmental impact calculations; in order to include the flight’s impact, the user could:

- Modify altitude controls as necessary to allow the restrictions to be met;
- Assign a different airplane that can meet the restrictions;
- Modify the airplane’s performance characteristic to enable it to meet the restrictions;
- Activate and adjust the user-defined thrust failure tolerance percentage, which allows an airplane to operate in excess of its modeled available thrust by the given percentage in order to comply with a control;
- Activate the restriction-ignore feature, which allows an airplane to operate in restricted altitude ranges without consequence;
- Activate and adjust the user-defined altitude failure override tolerance, which increases the amount by which airplanes can enter restricted altitude ranges;
- Activate the automatic weight adjustment feature, which prompts AEDT to re-attempt a flight at a lower weight if it fails; or
- Employ a combination of these strategies.

---

Note that an airplane must feature BADA performance data, as well as ANP performance data including procedural profiles (some airplanes have only fixed-point ANP profiles) in order to be used in conjunction with altitude controls.

AEDT computes control-driven flight performance according to two performance specifications: Doc 9911 and BADA. Doc 9911 is nominally used to model performance below 10,000 ft AFE, while BADA is used above that altitude (there are exceptions to this rule in the case of overflight operations). The different methodologies used for each performance specification are detailed in Section 3.9.1.5 (Doc 9911) and Section 3.9.1.6 (BADA).

#### **3.9.1.4 Overall Algorithm**

When controls are present, first the flight path is calculated from the procedure as though there are no controls, as described in Section 3.6. This “control-agnostic” flight path is then modified to match the control targets as closely as possible.

There are two major domains of control-driven analysis in AEDT: terminal-area analysis and en-route analysis. They are divided by the top-of-terminal altitude.

Terminal area analysis is performed with a preference for conforming to speed and flap schedules implied by a flight procedure, though the flight mechanics can be modeled according to either the Doc 9911 or the BADA 4 performance specification.

En-route analysis is performed using BADA speed and flap schedules, with flight mechanics modeled according to either BADA 3 or BADA 4. When there are target altitude and speed profiles, the top-of-terminal altitude is 10,000 ft MSL, and the terminal-area model and the en-route model are both BADA 4.

When there is only a target altitude profile, the top-of-terminal altitude is the altitude where BADA 3 climb begins in the control-agnostic flight path (see Section 3.6.2.8), if there is a BADA 3 climb, or 10,000 ft AFE otherwise; the terminal-area model is Doc 9911, and the en-route model is BADA 3.

#### **3.9.1.5 Terminal-Area Control Target Matching**

When there are target MSL altitude (feet) and KCAS profiles, only the ground-roll points in the standard flight path are retained. When there is only a target MSL altitude profile, points in the standard flight path are retained or discarded based on the properties of the altitude control that is closest to the runway. Points are retained if they are closer to the runway than that control by at least 1,000 ft laterally, and if their altitude is lower than the control’s target MSL altitude. Points which do not meet both of these criteria are discarded. Figure 3-21 illustrates which standard flight path points are preserved.

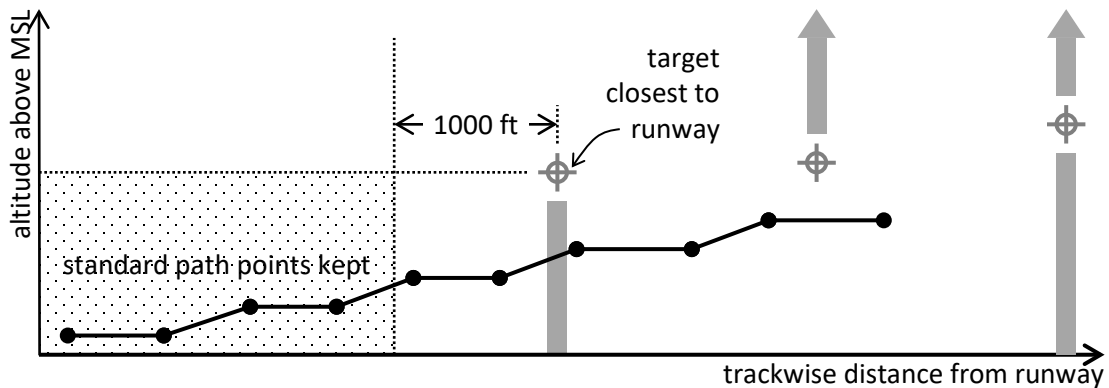

Figure 3-21 Preserved Portion of Standard Path in Altitude-Controlled Flights

If the entire preserved portion of the standard flight path is in the terminal area, performance beyond the preserved content is calculated nominally according to the terminal-area performance specification up to the top-of-terminal altitude. For each track point with an observed control, working trackwise away from the runway, the flight is computed to the associated target distance and as close as possible to the target altitude (and KCAS, if there is a target KCAS profile), as described in Section 3.9.1.5.1. If the achieved altitude and KCAS do not violate any restrictions posed by observed controls at the track point, analysis of the flight proceeds to the next track point with an observed control. If the airplane altitude reaches or exceeds the top-of-terminal altitude at any control, the result is truncated at the top-of-terminal altitude as necessary, and terminal-area control target matching ends. For Doc9911-BADA3 analysis, this point at the top of the terminal is the Doc9911-BADA3 transition point.

#### 3.9.1.5.1 Analysis of Flight to or from Controlled Track Point

At the beginning of analysis for any control, the following quantities are known:

- $h_T$  is the target MSL altitude (feet),
- $d_T$  is the target track coordinate,
- $h_L$  is the latest MSL altitude (feet),
- $d_L$  is the latest track coordinate,
- $R_L$  is the latest drag-to-lift ratio,
- $v_{CL}$  is the latest KCAS,
- $t_L$  is the latest time,
- $\Phi$  is the aircraft's course,
- $\varphi$  is the aircraft's latitude,
- $\lambda$  is the aircraft's longitude.

If there are both altitude and speed target profiles, the target KCAS is also known.

The drag-to-lift ratio to use for the step,  $R$ , is chosen according to the flap schedule, based on  $R_L$  and  $v_{CL}$ , the radius of curvature, and the aircraft course,  $\Phi$ , to be used for the step sampled at  $d_L$ . The latest aircraft latitude,  $\varphi_L$ , and the latest aircraft longitude,  $\lambda_L$ , are also sampled at  $d_L$ . The latest weather conditions are sampled at  $\{t_L, \varphi_L, \lambda_L, h_L\}$ . The latest KTAS,  $v_{TL}$ , is calculated from latest weather and  $v_{CL}$ . The target step height is given by:

$$\Delta h_T = h_T - h_L \quad \text{Eq. 3-139}$$

The target step trackwise length is:

$$\Delta d = |d_T - d_L| \quad \text{Eq. 3-140}$$

AEDT determines the closest achievable altitude at the target distance by calculating the thrust required for flight to a number of candidate altitudes and/or calibrated airspeeds, and comparing the required thrust to the thrust available. If there are altitude and KCAS target profiles, this determination is made as described in Section 3.9.1.5.1.1. If there is only a target altitude profile, the determination is made in one of two ways, depending on the operation type, the latest state, the KCAS schedule, and the target altitude. If the operation is not an approach, target altitude is at or above the latest altitude, and the latest KCAS is at or below the KCAS scheduled at the latest altitude, then recursive bisection is used, as described in Section 3.9.1.5.1.3. Otherwise, progressive decimation is used, as described in Section 3.9.1.5.1.4.

#### 3.9.1.5.1.1 Best-Effort Calculation with Altitude and KCAS Target Profiles

This approach to determining the best effort to reach a target altitude and KCAS involves three key candidate pairs of next altitude and KCAS:

1. Target MSL altitude (feet), target KCAS;
2. Target MSL altitude (feet), minimum KCAS;
3. Latest MSL altitude (feet), minimum KCAS.

Here, minimum KCAS is the lesser of the latest KCAS and the target KCAS. Performance for a candidate pair is computed as described in Section 3.9.1.5.1.2.

- If available thrust is greater than or equal to required thrust for key candidate 1, it is selected as the best effort.
- If available thrust is less than required thrust for the key candidate 1, but greater than or equal to required thrust for key candidate 2, a candidate with next altitude equal to target altitude and required thrust equal to available thrust is identified by recursive bisection of candidates' next KCAS between minimum KCAS and target KCAS, and that candidate is selected as the best effort.
- If available thrust is less than required thrust for key candidate 2, but greater than or equal to required thrust for the key candidate 3, a candidate with next KCAS equal to minimum KCAS and required thrust equal to available thrust is identified by recursive bisection of candidates' next altitude between latest altitude and target altitude, and that candidate is selected as the best effort.
- If available thrust is less than required thrust for key candidate 3, then the flight fails.

### 3.9.1.5.1.2 Analysis of Flight to Candidate Altitude and KCAS

Analysis of flight for a candidate MSL altitude-KCAS pair is identical to the analysis for a candidate altitude as described in Section 3.9.1.5.2, except that:

- KCAS is given rather than computed from the procedure-based speed schedule.
- Thrust is computed by the BADA energy balance equation Eq. 3-162 instead of the Doc 9911-based force balance equation Eq. 3-153.
- Drag is computed. This is done according to the BADA 4 specification based on local conditions, airplane-specific coefficients, and the airplane configuration and state.
- The airplane configuration is determined via a map from the scheduled ANP flap setting to a corresponding BADA 4 configuration. If no ANP flap setting is available, the BADA 4 scheduled flap schedule is used.

### 3.9.1.5.1.3 Best-Effort Calculation through Recursive Bisection

This approach to determining the best effort to reach a control target can be broken into four phases. Note that in the descriptions of the phases that follow, when an MSL altitude and KCAS pair are “checked”, it means that they are tested together as a candidate final state as described in Section 3.9.1.5.2 to determine whether or not there is enough thrust available to reach them at the target distance. The four phases are as follows:

1. The target final MSL altitude (feet) and the KCAS scheduled are checked to determine whether or not they are supported by the available thrust. If so, they are selected as the final state, and the algorithm terminates. Otherwise, the latest altitude and KCAS are checked to verify that they are supported; if not, the flight fails.
2. The interval between the latest altitude and the target altitude is searched, through recursive bisection, for the lowest final altitude at which the KCAS scheduled there is unsupported by the available thrust (“lowest schedule-unsupported final altitude”). This is provisionally selected as the final altitude, subject to degradation as described in the next phase. Note that this process also identifies the highest final altitude at which the scheduled KCAS is supported by the available thrust (“highest schedule-supported final altitude”), if it exists on the interval.
3. The latest KCAS and the lowest schedule-unsupported final altitude are checked for support. If unsupported, then the final state is degraded to the highest schedule-supported final altitude, and the KCAS scheduled there, terminating the algorithm.
4. At the lowest schedule-unsupported final altitude, the interval between the latest KCAS and the KCAS scheduled at that altitude is searched, through recursive bisection, for the highest final KCAS that is supported. This altitude and KCAS are then selected as the final state, and the algorithm terminates.

This process is illustrated in terms of the KCAS schedule in Figure 3-22.



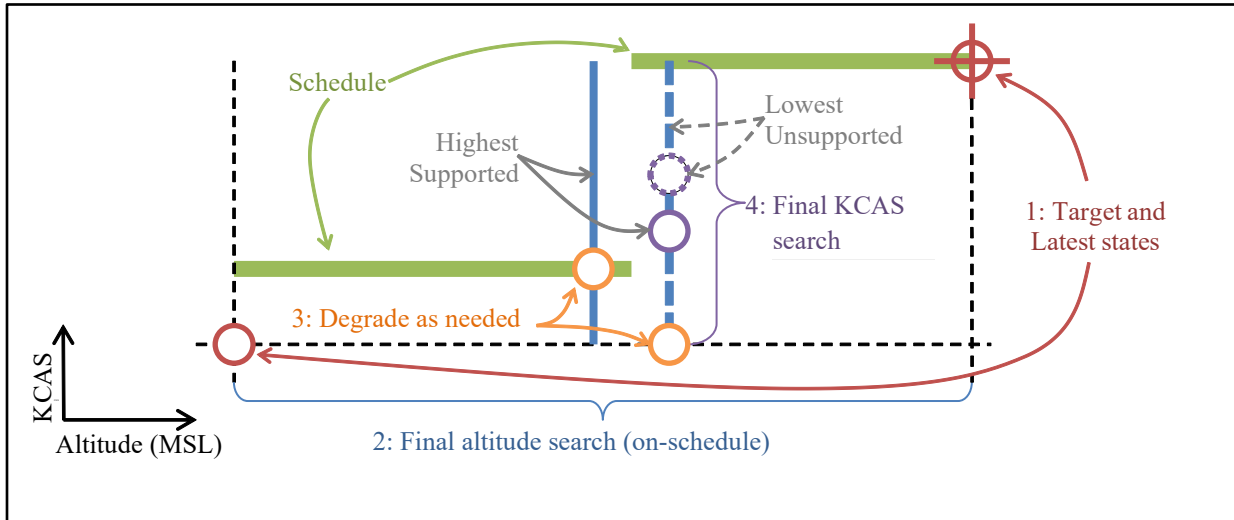

Figure 3-22 Phases of Best-Effort Calculation through Recursive Bisection

### 3.9.1.5.1.4 Best-Effort Calculation through Progressive Decimation

In this approach to determining the best effort reach the target MSL altitude (feet), the number of candidate altitudes,  $N$ , is given by:

$$N = \begin{cases} 1 & \text{if below is not allowed} \\ 11 & \text{otherwise} \end{cases} \quad \text{Eq. 3-141}$$

The  $j^{\text{th}}$  candidate altitude to be tested ( $j$  ranges from 0 to  $N-1$ ) is:

$$h_{c_j} = h_T - \frac{j}{10} \Delta h_T \quad \text{Eq. 3-142}$$

For each candidate altitude, flight to that altitude and the target distance is calculated as described in Section 3.9.1.5.2. If the required thrust does not exceed the available thrust, then flight to the candidate is supported. If flight to any of the candidate altitudes is supported by available thrust, then the supported candidate that is closest to the target altitude is selected as the altitude for the aircraft at the track point. This process is illustrated for the case of an “AtOrBelow” control in Figure 3-23.

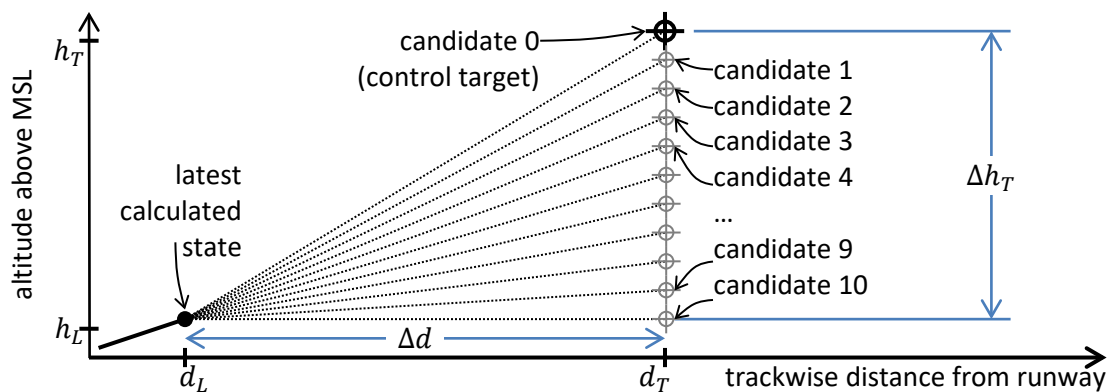

Figure 3-23 Candidate Altitudes for Flight To or From an “AtOrBelow” Altitude Control

3.9.1.5.2 Analysis of Flight to Candidate Altitude

At the beginning of analysis for any candidate altitude, latest MSL altitude (feet)  $h_L$  and the candidate MSL altitude (feet)  $h_C$  are known. The initial altitude,  $h_i$  is:

$$h_i = \begin{cases} h_C & \text{for approaches} \\ h_L & \text{otherwise} \end{cases} \quad \text{Eq. 3-143}$$

The final altitude  $h_f$  is:

$$h_f = \begin{cases} h_L & \text{for approaches} \\ h_C & \text{otherwise} \end{cases} \quad \text{Eq. 3-144}$$

The relationships that initial and final states have with latest and candidate states differs in this way because approach segments are processed in reverse temporal order as described earlier. These are illustrated in Figure 3-24 for departures and overflights, and in Figure 3-25 for approaches.

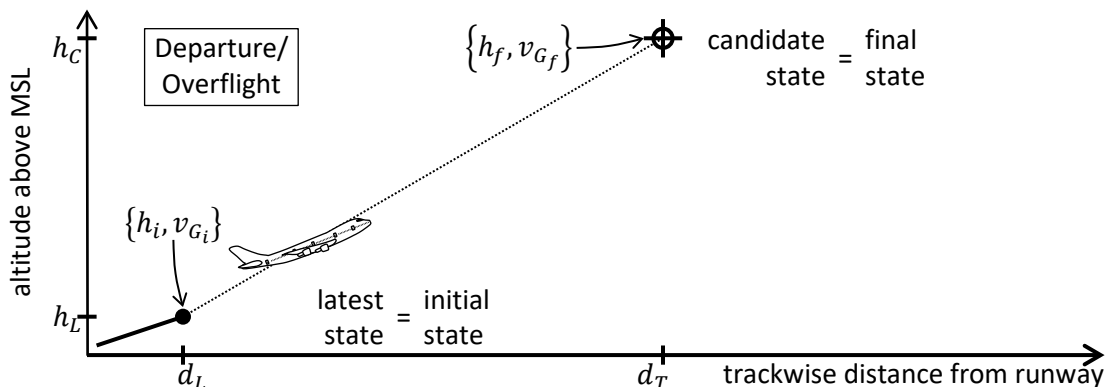

Figure 3-24 Relationships Between Initial, Final, Latest, and Candidate for Departures and Overflights

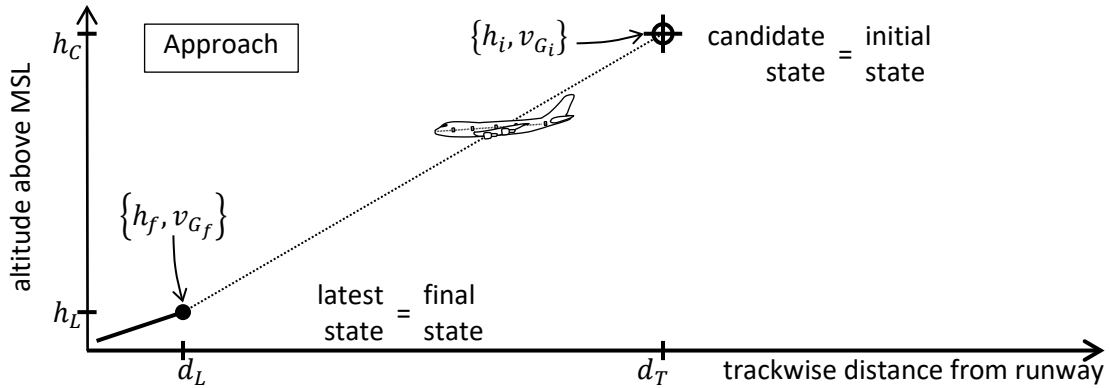

Figure 3-25 Relationships Between Initial, Final, Latest, and Candidate for Approaches

The candidate change in altitude is:

$$\Delta h = h_f - h_i \tag{Eq. 3-145}$$

Climb angle in the still-ground frame of reference is:

$$\gamma_G = \tan^{-1}(\Delta h / \Delta d) \tag{Eq. 3-146}$$

The latest groundspeed,  $v_{G_L}$  (knots), is calculated from  $v_{T_L}$ ,  $\gamma_G$ ,  $\Phi$ , and latest weather. The candidate KCAS,  $v_{C_C}$ , is determined from KCAS schedule based on  $h_C$ . The candidate weather conditions are sampled at  $\{t_L, \phi_L, \lambda_L, h_C\}$ . The candidate true airspeed,  $v_{T_C}$ , is calculated from candidate weather and  $v_{C_C}$ . The candidate groundspeed,  $v_{G_C}$ , is calculated from  $v_{T_C}$ ,  $\gamma_G$ ,  $\Phi$ , and candidate weather. The initial groundspeed  $v_{G_i}$  is:

$$v_{G_i} = \begin{cases} v_{G_C} & \text{for approaches} \\ v_{G_L} & \text{otherwise} \end{cases} \tag{Eq. 3-147}$$

The final groundspeed  $v_{G_f}$  is:

$$v_{G_f} = \begin{cases} v_{G_L} & \text{for approaches} \\ v_{G_C} & \text{otherwise} \end{cases} \tag{Eq. 3-148}$$

The average groundspeed is:

$$\overline{v_G} = \frac{1}{2}(v_{G_i} + v_{G_f}) \quad \text{Eq. 3-149}$$

The pathwise step length is:

$$\Delta s = \sqrt{\Delta d^2 + \Delta h^2} \quad \text{Eq. 3-150}$$

The step duration is:

$$\Delta t = \Delta s / \overline{v_G} \quad \text{Eq. 3-151}$$

The step acceleration is:

$$a = \frac{v_{G_f}^2 - v_{G_i}^2}{2\Delta s} \quad \text{Eq. 3-152}$$

The bank angle,  $\varepsilon$ , is calculated from  $r$  and  $v_{G_L}$ . The aircraft weight,  $W$  is taken from the procedural profile. The total thrust is determined by a force-balance based on ICAO Doc 9911<sup>67</sup> equation C-20, with the aerodynamic term adjusted for bank angle:

$$F = W \left[ R \frac{\cos \gamma_g}{\cos \varepsilon} + \sin \gamma_g + \frac{a}{g} \right] \quad \text{Eq. 3-153}$$

### 3.9.1.5.3 KCAS Schedule

A KCAS schedule is an indication of how an airplane's calibrated airspeed (knots) should vary as a function of AFE altitude. Airplane procedures provide information about the calibrated airspeeds at which the associated airplane might safely and realistically fly while in certain AFE altitude ranges. For operations with altitude controls, AEDT analyzes the procedure to establish a KCAS schedule. The calibrated airspeeds used in performance calculations between controls are chosen in accordance with this schedule.

The construction of a flap schedule begins with the determination of the initial and final KCAS and altitude for each step in the procedure, as outlined in Section 3.9.1.5.5 and Section 3.9.1.5.6. After the KCAS and altitude progression for each procedure step has been established, the flap schedule construction process continues by defining a "bin" for each step. The bin is assigned the step's initial and final altitude and KCAS, and its index within the procedure (the first step has index 1, the second has index 2, etc.). The resulting collection of bins constitutes the KCAS schedule; for a given altitude, the scheduled KCAS is interpolated from the values in the bin with the highest index among bins that contain that altitude.

#### 3.9.1.5.4 Flap Schedule and Selection

A flap schedule is an indication of how an airplane's drag-to-lift ratio should vary as a function of calibrated airspeed. Airplane procedures provide information about the drag-to-lift ratios the associated airplane might realistically use while in certain KCAS ranges. For operations with altitude controls, AEDT analyzes the procedure to establish a flap schedule. The drag-to-lift ratios used in performance calculations between controls are usually chosen in accordance with this schedule. Note, however, that drag-to-lift ratio is never increased over the course of a departure operation, and is never reduced over the course of an approach operation.

The construction of a flap schedule begins with the determination of the initial and final KCAS for each step in the procedure, as outlined in Section 3.9.1.5.5. After the KCAS progression for each procedure step has been established, the flap schedule construction process continues by defining a "bin" for each step for which the drag-to-lift ratio is specified. The bin is assigned the step's drag-to-lift ratio, its KCAS range, and its index within the procedure (the first step has index 1, the second has index 2, etc.). Next, AEDT identifies all ranges of KCAS that are not covered by bins. For each of these ranges, an additional bin is defined with that KCAS range and the index and drag-to-lift ratio of the adjacent bin with the highest index. The resulting collection of bins constitutes the flap schedule; for a given KCAS, the scheduled drag-to-lift ratio is the value from the bin with the highest index among bins that contain that KCAS.

#### 3.9.1.5.5 Procedural KCAS Progression

Construction of KCAS schedules and flap schedules requires determination of the progression of KCAS over the course of the procedure. The amount of KCAS information specified by a procedure step depends on the step type; steps may provide information about their initial KCAS, final KCAS, both, or neither. The nature of any KCAS information provided also depends on the step type; KCAS may be provided as a specific value (ex. 250 knots), as a conceptual value that can be computed (ex. "initial climb KCAS" or "touch-down KCAS"), or as a procedural notion (ex. "maintain current KCAS"). KCAS values are determined at the beginning and end of the procedure, as well as at the interface between each pair of adjacent procedure steps. Note that adjacent procedure steps can specify conflicting KCAS information for the point at which they meet, in which case one or the other is chosen based on the order and types of the two steps.

To facilitate this determination, each type of step is assigned initial and final ranks that indicate how strongly any information from the step about that KCAS value should be weighted. Ranks, from highest to lowest, are:

- Imposed,
- Preferred,
- Provided,
- Allowed,
- Unavailable.

The initial and final KCAS ranks associated with each step type are as follows:

Initial KCAS Rank	Step Type	Final CAS Rank
Imposed	Takeoff ground roll	Imposed
Unavailable	Accelerate	Imposed
Allowed	Cruise climb	Imposed
Unavailable	Climb	Imposed
Preferred	Level	Provided
Preferred	Descend	Provided
Imposed	Landing ground roll	Unavailable
Imposed	Brake	Preferred

At each interface between two adjacent procedure steps, the KCAS information from the higher-ranked step takes precedence over the lower-ranked step. For example, for a level step that is followed by a descend step, the level step's final KCAS information is "Provided", whereas the descend step's initial KCAS information is "Preferred"; the higher rank takes precedence, so the level step ends (and the descend step begins) at the descend step's initial KCAS.

#### 3.9.1.5.6 Procedural Altitude Progression

Construction of KCAS schedules requires determination of the progression of AFE altitude over the course of the procedure. The amount of altitude information specified by a procedure step depends on the step type; steps may provide information about their initial altitude, final altitude, both, or neither. The nature of any altitude information provided also depends on the step type; altitude may be provided as a specific value (ex. 1,000 ft), as a conceptual value that can be computed (ex. "on the ground"), or as a procedural notion (ex. "maintain current altitude"). Altitude values are determined at the beginning and end of the procedure, as well as at the interface between each pair of adjacent procedure steps. Note that adjacent procedure steps could specify conflicting altitude information for the point at which they meet, in which case one or the other is chosen based on the order and types of the two steps.

To facilitate this determination, each type of step is assigned initial and final ranks that indicate how strongly any information from the step about that altitude value should be weighted. Ranks, from highest to lowest, are

- Imposed,
- Preferred,
- Provided,
- Allowed,
- Unavailable.

The initial and final altitude ranks associated with each step type are as follows:

Initial Altitude Rank	Step Type	Final Altitude Rank
Imposed	Takeoff ground roll	Imposed
Unavailable	Accelerate	Imposed

Initial Altitude Rank	Step Type	Final Altitude Rank
Allowed	Cruise climb	Imposed
Unavailable	Climb	Imposed
Preferred	Level	Imposed
Preferred	Descend	Unavailable
Imposed	Landing ground roll	Imposed
Imposed	Brake	Imposed

At each interface between two adjacent procedure steps, the altitude information from the higher-ranked step takes precedence over the lower-ranked step. For example, for a level step that is followed by a descend step, the level step's final altitude information is Imposed, whereas the descend step's initial altitude information is Preferred; the higher rank takes precedence, so the level step ends (and the descend step begins) at the level step's final altitude.

### 3.9.1.6 *En-Route Target Matching for Altitude and KCAS*

In the case where there are both MSL altitude (feet) and KCAS target profiles, analysis is nominally as described in Section 3.9.1.5 Terminal-Area Control Target Matching. The only difference is that the airplane configuration is always based on the BADA 4 flap schedule, rather than attempting to map the procedure-scheduled ANP flap setting to a BADA 4 configuration.

### 3.9.1.7 *En-Route Control Target Matching for Altitude Only*

When there is only a target MSL altitude (feet) profile, BADA 3 is used to simulate trajectories, or parts of trajectories, beyond the point where they first reach the top-of-terminal altitude. Trajectory points calculated according to BADA are appended to any part of the trajectory in the terminal area (this includes the preserved portion of the standard procedure, as well as control-driven content up to the top-of-terminal altitude if there is any).

Fundamentally, AEDT uses BADA to model performance from one observed altitude control to the next, regardless of the number of track segments in between those controls. As a result, AEDT with BADA does not "plan ahead" for upcoming changes in altitude and has no mechanism to change previously calculated points, unlike the Doc 9911 portion of AEDT which can adjust target points.

#### 3.9.1.7.1 BADA 3 General Discussion

This section begins with an overview of the BADA 3 performance model. This is followed by introductions to the fundamental elements of the BADA 3 performance model.

##### 3.9.1.7.1.1 Overview

BADA does not specify the overall structure of a flight (it could consist of any number of climb, cruise, and descent phases, arranged in any order). Instead, BADA provides performance calculation rules and modeling coefficients for each phase. For each phase type, a speed schedule is specified as a sequence of calibrated airspeeds with corresponding AFE altitudes. Scheduled speeds increase with altitude. The maximum Mach number is also provided for each phase type. For the BADA weather model, each phase has a Mach transition altitude above which the maximum scheduled KCAS is always limited by the maximum Mach number. BADA performance for a phase consists of any number (zero or greater) of constant-KCAS steps below the Mach transition altitude, constant-Mach steps above Mach transition, and acceleration/deceleration steps.

For departures, the transition from the terminal-area methods to the en-route BADA 3 methods will only occur if the airplane's BADA 3 climb calibrated airspeed (KCAS) is faster than the airplane's Doc 9911 final KCAS. Aircraft which do accelerate to the faster BADA 3 climb speed use the methods of Section 3.9.1.7.2.1 for the initial acceleration. Aircraft which have a Doc 9911 final KCAS which is equal or faster than the BADA 3 climb speed continue to use the methods of Section 3.9.1.5. Because arrivals are modeled in reverse temporal order, aircraft which have BADA 3 en-route descent KCAS slower than the airplane's initial Doc 9911 arrival KCAS will use the Doc 9911 methods for the entire arrival.

Acceleration and deceleration steps below Mach transition serve to change KCAS, whereas steps above Mach transition serve to change the Mach number. Since AEDT uses the BADA model primarily for en-route phases of flight, only the KCAS scheduled for the en-route phase is used. Transitions between scheduled KCAS values are therefore not encountered. Acceleration/deceleration steps are only performed to transition between two BADA phases, or between a BADA phase and the Doc 9911 model.

#### 3.9.1.7.1.2 Mach Transition Altitude

Mach transition MSL altitude (meters) for a phase is calculated for a given KCAS and Mach number by the equation:

$$h_M = \left[ 1 - \frac{\left[ 1 + \left( \frac{\gamma - 1}{2} \right) \left( \frac{V}{V_{SLISA}} \right)^2 \right]^{\frac{\gamma}{\gamma - 1}} - 1}{\left[ 1 + \frac{\gamma - 1}{2} M^2 \right]^{\frac{\gamma}{\gamma - 1}} - 1} \right]^{\frac{\alpha_{ISA} R}{g}} \frac{T_{SL}}{\alpha_{ISA}} \quad \text{Eq. 3-154}$$

where

$\gamma$	Isentropic expansion coefficient for air 1.4 (dimensionless);
$R$	Real gas constant for air $287.04 \text{ m}^2/\text{K} / \text{s}^2$ ;
$V$	Calibrated airspeed (kt);
$V_{SLISA}$	Atmospheric speed of sound at sea level in an ISA (kt);
$M$	Aircraft Mach number (dimensionless);
$\alpha_{ISA}$	ISA temperature lapse rate 0.0065 K/m;
$g$	Gravitational acceleration of Earth $9.81 \text{ m/s}^2$ ; and
$T_{SL}$	Atmospheric temperature at sea level 288 K.

The tropopause altitude  $h_t$  (m) is calculated from:

$$h_t = h_{tISA} + \frac{\Delta T_{ISA SL}}{\alpha_{ISA}} \quad \text{Eq. 3-155}$$

where



$h_{t_{ISA}}$  ISA tropopause altitude (m); and  
 $\Delta T_{ISA_{SL}}$  Sea-level temperature deviation from ISA (K).

Note that AEDT calculates the sea-level temperature  $T_{SL}$  (K) by sampling the temperature at the associated airport and lapsing to sea-level:

$$T_{SL} = T_{airport} + \alpha_{ISA} h_{airport} \quad \text{Eq. 3-156}$$

where

$h_{airport}$  Airport elevation (m); and  
 $T_{airport}$  Atmospheric temperature at the airport elevation (K).

The temperature deviation from ISA follows directly as discussed in Section 3.3.1.2.

Also note that the calculation of Mach transition altitude is based on a lapsed weather model, similar to those discussed in Section 3.3.2.1. Because of this simplification, the actual weather at Mach transition can differ from the assumed weather if high-fidelity weather module is in use. As a result of this, there can be a discontinuity of several knots in the speed profile at the Mach transition.

#### 3.9.1.7.1.3 Energy Share

BADA makes use of an energy share factor when climbing or descending. The energy share factor is used to dictate how much of the available thrust is used towards climbing or descending and how much is used for forward thrust. The energy share is determined by the altitude regime currently being modeled. Using constant CAS, below the Mach transition altitude and below the tropopause the energy share,  $f\{M\}$ , is calculated via:

$$f\{M\} = \left\{ 1 + \frac{\gamma \cdot R \cdot \alpha_{ISA}}{2 \cdot g} \cdot M^2 + \left( 1 + \frac{\gamma - 1}{2} \cdot M^2 \right)^{\frac{-1}{\gamma - 1}} \left\{ \left( 1 + \frac{\gamma - 1}{2} \cdot M^2 \right)^{\frac{\gamma}{\gamma - 1}} - 1 \right\} \right\}^{-1} \quad \text{Eq. 3-157}$$

where

$\alpha_{ISA}$  ISA temperature gradient with altitude, -.0065 K/m

When above the tropopause, but below the Mach transition altitude, and using constant CAS, a different equation is used, as follows.

$$f\{M\} = \left\{ 1 + \left( 1 + \frac{\gamma - 1}{2} \cdot M^2 \right)^{\frac{-1}{\gamma - 1}} \left[ \left( 1 + \frac{\gamma - 1}{2} \cdot M^2 \right)^{\frac{\gamma}{\gamma - 1}} - 1 \right] \right\}^{-1} \quad \text{Eq. 3-158}$$

When below the tropopause at constant Mach, the equation below is used.

$$f\{M\} = \left[ 1 + \frac{\gamma \cdot R \cdot k_T}{2 \cdot g} M^2 \right]^{-1} \quad \text{Eq. 3-159}$$

Constant Mach above the tropopause uses the following equation:

$$f\{M\} = 1.0 \quad \text{Eq. 3-160}$$

Finally, in cases where neither constant CAS nor constant Mach is used, the energy share factors are given by the following:

Acceleration in climb  $f\{M\} = 0.3$   
 Deceleration in descent  $f\{M\} = 0.3$   
 Deceleration in climb  $f\{M\} = 1.7$   
 Acceleration in descent  $f\{M\} = 1.7$

#### 3.9.1.7.1.4 Drag

AEDT reports the physics-based thrust calculation for approach for ANP, which means that some operations can have a negative thrust value for some approach segments when more drag than thrust is being generated. The negative thrust is only reported in the flight performance report; but the noise thrust values are limited to non-negative values for noise modeling purposes. Segments with negative flight performance thrust have the noise modeling thrust set to a nominal value of one pound of corrected net thrust per engine. Similarly, segments with negative flight performance thrust are limited to a minimum fuel flow rate for fuel burn and emissions calculations. When the ANP and BADA 3 performance models are used, AEDT uses the BADA 3 fuel consumption model (see Section 3.4.1) or the SFI fuel consumption model (see Section 3.4.2) to calculate the fuel flow. In both of these cases, the BADA 3 minimum fuel flow rate is used as a floor for the final result of that calculation. The BADA 3 fuel flow rate does not have a thrust dependency, it is dependent on altitude alone, so it is not affected by negative values of flight performance thrust. The BADA 3 minimum fuel flow rate corresponds to idle thrust descent conditions. Similarly, when the BADA 4 performance model is used, AEDT uses the BADA 4 fuel consumption model (see Section 3.7.10) to calculate fuel flow and the BADA 4 idle fuel flow coefficient is used as a floor to the general BADA4 fuel flow calculation. The BADA4 idle fuel coefficient also does not have a thrust dependency, though it does depend on Mach number, theta, and delta. In addition, the BADA 4 idle fuel flow coefficient is also used as a floor when the user has selected BADA 4 performance, but thrust for the step is being computed by the ANP performance model.

Drag  $D$  (N) is calculated from:

$$D = \left[ C_{D0,CR} + C_{D2,CR} \left( \frac{mg}{\frac{1}{2} \rho V_T^2 S \cos \epsilon} \right)^2 \right] \frac{1}{2} \rho V_T^2 S \quad \text{Eq. 3-161}$$

where

$C_{D0,CR}$	Parasitic drag coefficient in cruise configuration (dimensionless);
$C_{D2,CR}$	Induced drag coefficient in cruise configuration (dimensionless);
$\varepsilon$	Bank angle (radians);
$S$	Reference wing surface area (m <sup>2</sup> );
$m$	Aircraft mass (kg);
$\rho$	Atmospheric density (kg/m <sup>3</sup> ); and
$V_T$	Aircraft true airspeed (m/s).

### 3.9.1.7.1.5 Thrust

With enough information, required thrust can be calculated through an energy balance:

$$F = m \left( \frac{g}{V_T} \frac{dh}{dt} + a \right) + D \quad \text{Eq. 3-162}$$

or

$$F = \left[ \frac{m \cdot g}{f\{M\} \cdot V_T} \right] \cdot \frac{dh}{dt} + D \quad \text{Eq. 3-163}$$

where

$F$	Aircraft total net thrust (N);
$D$	Aircraft drag (N);
$a$	Aircraft acceleration (m/s <sup>2</sup> );
$\frac{dh}{dt}$	Aircraft climb rate (m/s); and
$f\{M\}$	Energy share.

The maximum total available net thrust during climb in an ISA is given by:

$$F_{m_{CISA}} = \begin{cases} C_{Tc1} \times \left( 1 - \frac{h}{C_{Tc2}} + C_{Tc3} \times h^2 \right) \text{ (jet)} \\ C_{Tc1} \times \left( 1 - \frac{h}{C_{Tc2}} \right) / V_T + C_{Tc3} \text{ (turboprop)} \\ C_{Tc1} \times \left( 1 - \frac{h}{C_{Tc2}} \right) + \frac{C_{Tc3}}{V_T} \text{ (piston)} \end{cases} \quad \text{Eq. 3-164}$$

where

$h$	Aircraft altitude above mean sea level (ft);
$C_{Tc,1}$	1st max climb thrust coefficient (N for jet or piston, kN for turboprop);
$C_{Tc,2}$	2nd max climb thrust coefficient (ft); and
$C_{Tc,3}$	3rd max climb thrust coefficient (ft <sup>2</sup> for jet, N for turboprop, kN for piston).

The maximum total net thrust during climb  $F_{m_c}$  (N) for all weather contexts is given by:

$$F_{m_c} = \left( 1 - C_{Tc5} \Delta T_{ISAeff} \right) F_{m_{CISA}} \quad \text{Eq. 3-165}$$

with

$$\Delta T_{ISA_{eff}} = \Delta T_{ISA} - C_{Tc,4} \quad \text{Eq. 3-166}$$

and the limitations that

$$0.0 \leq C_{Tc5} \cdot \Delta T_{ISA_{eff}} \leq 0.4 \quad \text{Eq. 3-167}$$

and

$$C_{Tc5} \geq 0.0 \quad \text{Eq. 3-168}$$

where

- $\Delta T_{ISA}$  Atmospheric temperature deviation from ISA (K);
- $C_{Tc,4}$  1st thrust temperature coefficient (K); and
- $C_{Tc,5}$  2nd thrust temperature coefficient (K<sup>-1</sup>).

The power reduction coefficient is

$$C_{pow,red} = 1 - C_{red} \cdot \frac{m_{max} - m}{m_{max} - m_{min}} \quad \text{Eq. 3-169}$$

where

- $m_{max}$  Aircraft's maximum mass (kg);
- $m_{min}$  Aircraft's minimum mass (kg);
- $C_{red}$  Reduction coefficient (dimensionless) determined by the BADA 3 aircraft engine type:

$$C_{red} = \begin{cases} 0.15(\text{jet}) \\ 0.25(\text{turboprop}) \\ 0.0(\text{piston}) \end{cases}$$

The standard reduced total climb thrust  $F_{rC}$  (N) is:

$$F_{rC} = D + (F_{mC} - D)C_{pow,red} \quad \text{Eq. 3-170}$$

The maximum total net thrust during cruise  $F_{mV}$  (N) is:

$$F_{mV} = C_{Tcr}F_{mC} \quad \text{Eq. 3-171}$$

where

- $F_{mC}$  Aircraft maximum total net thrust in climb (N); and
- $C_{Tcr}$  Maximum cruise thrust coefficient 0.95 (dimensionless).

The standard total net thrust during descent  $F_{mD}$  (N) is:

$$F_{mD} = \begin{cases} C_{TD_{hi}} F_{mC} (h > h_{des}) \\ C_{TD_{lo}} F_{mC} (h \leq h_{des}) \end{cases} \quad \text{Eq. 3-172}$$

where

- $C_{TD_{lo}}$  Low altitude descent thrust coefficient (dimensionless);
- $C_{TD_{hi}}$  High altitude descent thrust coefficient (dimensionless); and

$h_{des}$  Transition altitude for calculation of descent thrust (ft).

### 3.9.1.7.1.6 Speed and Altitude Limits

The maximum MSL altitude achievable by the aircraft  $h_m$  (ft) is given by:

$$h_m = \min[h_{MO}, h_{max_0} + (\Delta T_{ISA} - C_{Tc,4})G_t + (m_{max} - m)G_w] \quad \text{Eq. 3-173}$$

where

$h_{max_0}$  Maximum altitude at MTOW under ISA conditions for maximum mass (allowing residual 300fpm ROC) (ft);

$h_{MO}$  Maximum operational height above sea level (ft);

$G_w$  Mass gradient on maximum altitude (ft/kg);

$G_t$  Temperature gradient on maximum altitude (ft/K);

$m_{max}$  Maximum mass (kg);

$C_{Tc,4}$  1st thrust temperature coefficient (K);

$m$  Aircraft mass (kg); and

$\Delta T_{ISA}$  Atmospheric temperature deviation from ISA (K).

The minimum calibrated airspeed in cruise  $V_{min_{CR}}$  (kt) is calculated from:

$$V_{min_{CR}} = C_{Vmin} \cdot V_{stall_{CR}} \quad \text{Eq. 3-174}$$

where

$C_{Vmin}$  Minimum speed coefficient in non-take-off configuration (dimensionless); and

$V_{stall_{CR}}$  Aircraft's stall speed in cruise configuration (kt).

### 3.9.1.7.1.7 True Airspeed, Calibrated Airspeed and Mach Number

The relationship of true airspeed, calibrated airspeed, and Mach number is not unique to the performance model being used and is, therefore, only presented once in this Manual in Section 3.7.4 Speed Conversions.

### 3.9.1.7.2 En-Route Recalculation for Departure Operations

The calculation of the en-route portion of departures begins with determining what calibrated airspeed (CAS) and maximum Mach number should characterize the climbout phase. The climbout CAS is taken to be the larger of the aircraft's BADA 3 en-route climbout CAS and the CAS at the Doc9911-BADA3 transition point. Likewise, the maximum Mach number is taken to be the larger of the aircraft's BADA 3 en-route climbout maximum Mach number and the Mach number at the Doc9911-BADA3 transition point.

Departure operations cannot have descending altitude control to altitude control steps, so AEDT checks that all departure steps will be either climb or level steps. Recalculation of the en-route flight profile begins from the Doc9911-BADA3 transition point and continues to each successive altitude control further along the track with an altitude greater than 10,000 ft MSL. Each control constitutes a target MSL altitude and distance, to be reached from the latest calculated state (distance, altitude, speed, thrust, etc.). For the performance calculations for each target, the headwind is fixed to its value at the

latest calculated location and time, and the atmospheric thermodynamic profiles are fixed to the profiles at the latest calculated geographic coordinate and time. Under these conditions, a profile is calculated according to the BADA specification to the target distance, with adjustments made to energy share and thrust to come as close as possible to the target altitude. If the aircraft state at the target distance does not meet the constraint imposed by the altitude control, the flight fails, and AEDT issues a message accordingly.

The profile calculated to each target is comprised of one or more steps. The latest calculated state is compared to the en-route climb parameters to determine an appropriate step type and limiting values for clipping (by interpolation). If the latest CAS is less than the climbout CAS and the latest Mach number is less than the climbout maximum Mach number, a full BADA increasing-CAS climb step is calculated and clipped where it reaches the target distance and/or the maximum Mach number. If the latest CAS is not less than climbout CAS but the latest Mach number is less than the climbout maximum Mach number, a BADA constant-CAS step is calculated to the target distance and clipped where it reaches the maximum Mach number. This step evaluation and clipping provide a new latest calculated state, and the process is repeated until the latest state is at the target distance. Note that discontinuities at the Doc9911-BADA3 transition are smoothed over the entire segment of the first step computed according to BADA 3, which could be an acceleration or a climb.

#### 3.9.1.7.2.1 Full BADA Increasing-CAS Climb Step

In the case of increasing CAS during climb, the energy share is held at a constant value and a final CAS is targeted. With the final CAS constrained, the final true airspeed (TAS) is a function of the step height. The step height and final TAS are not directly calculable, but can be iteratively determined together by finding the root of the function:

$$F(h_f) = \frac{1}{2g} \frac{v_{T_f}^2(h_f) - v_{T_i}^2}{h_f - h_i} - \frac{1 - f\{M\}}{f\{M\}} \quad \text{Eq. 3-175}$$

where

$F(h_f)$	Function whose root is the altitude where the target CAS is reached (dimensionless);
$h_f$	Final altitude (m);
$h_i$	Initial altitude (m);
$f\{M\}$	BADA standard climb energy share for increasing-CAS climb 0.3 (dimensionless);
$g$	Earth's gravitational acceleration (m/s <sup>2</sup> );
$v_{T_i}$	Initial true airspeed (m/s); and
$v_{T_f}(h_f)$	Final true airspeed (m/s).

This does not resolve the step length, however. The length of the step is related to the thrust through the climb angle equation Eq. 3-163. By solving this for the step length of the BADA maximum thrust setting at the final MSL altitude, AEDT determines the shortest step length (steepest climb angle and largest acceleration) supported there.

If the climb angle of the standard BADA increasing-CAS climb step exceeds the angle of a direct climb to the target, the angle could be reduced either by reducing thrust or by reducing energy share. Since it is

not realistic to reduce thrust while attempting to accelerate, AEDT calculates a reduced-angle increasing-CAS climb at full thrust, implicitly reducing the climb energy share below the standard value. With climb angle constrained, the geometry of the step is determined by iteratively finding the root of the function:

$$F(L) = \frac{T_m(L) - D(L)}{mg} - \sin \gamma - \frac{1}{g} \frac{\Delta v_T^2(L)}{2L} \quad \text{Eq. 3-176}$$

where

$F(L)$	Function whose root is the step length where the target CAS is reached (dimensionless);
$L$	Step length (m);
$T_m(L)$	BADA maximum climb thrust (N);
$D(L)$	BADA drag (N);
$m$	Aircraft mass (kg);
$g$	Earth's gravitational acceleration (m/s <sup>2</sup> );
$\gamma$	Target climb angle (radians); and
$\Delta v_T(L)$	Final true airspeed (m/s).

#### 3.9.1.7.2.2 Constant CAS or Constant Mach Climb

For constant-CAS and constant-Mach BADA climbs, a target AFE altitude and target climb angle are provided, and one aspect of speed is held fixed. AEDT begins by determining whether or not the target climb angle is supported at the target altitude by evaluating equation Eq. 3-163 for the climb angle using the target altitude and maximum climb thrust setting, using the appropriate energy share equation as discussed in Section 3.9.1.7.1.3. If the climb angle supported by maximum thrust at the target altitude meets or exceeds the target climb angle, the target is reached, and equation Eq. 3-163 is evaluated for thrust using the target climb angle and altitude. If the target climb angle is not supported by the maximum thrust at the target altitude, the maximum achievable altitude is determined by iteratively finding the root of the function:

$$F(h_f) = \frac{T_m(h_f) - D(h_f)}{mg} f\{M(h_f)\} - \frac{h_f - h_i}{\sqrt{\Delta d^2 + [h_f - h_i]^2}} \quad \text{Eq. 3-177}$$

where

$F(h_f)$	Function whose root is the maximum achievable step height (dimensionless);
$h_f$	Final altitude (m);
$h_i$	Initial altitude (m);
$T_m(h_f)$	BADA maximum climb thrust (N);
$D(h_f)$	BADA drag (N);
$m$	Aircraft mass (kg);
$g$	Earth's gravitational acceleration (m/s <sup>2</sup> );
$f\{M(h_f)\}$	BADA climb energy share for the given speed conditions; and
$\Delta d$	Distance to target (m).

### 3.9.1.7.3 Approach Operations

Approach operations cannot have ascending altitude control to altitude control steps, so AEDT ensures that all steps will be either descend or level steps. Thus, AEDT looks for the first altitude control with an MSL altitude greater than 10,000 ft. Once it is determined which track segment to start modeling on, AEDT loops through the rest of the track segments, modeling from track segment to track segment as the altitude controls dictate.

Once the index of the next track segment in the track segment list is identified, the track segment is considered the current segment. The next altitude control following the current segment is then located in the list of track segments. The current segment and the next segment bridge a descent step. For the first BADA step, a decelerating descent step is substituted for a pure descent step, as the aircraft must transition from scheduled BADA CAS to interpolated Doc 9911 speeds. If one decelerating descent step is unable to slow down enough, the decelerating descent step is used again, until the speeds can be smoothly transitioned. After a step has been modeled, the next track segment becomes the current segment and a new next track segment is identified. This loop is repeated until all track segments with altitude controls have been modeled.

Approaches are modeled in reverse, from a step to step perspective. That is, the order of descending steps begins with the descent to 10,000 ft AFE and ends with the descent from the cruise altitude.

#### 3.9.1.7.3.1 Descend Steps

When calculating a descend step, first a determination must be made regarding in which MSL altitude region the step is taking place. If the descent will cross the Mach transition altitude, the step will be split into two pieces, one going from the starting step altitude dropping to the Mach transition altitude using the BADA Mach velocity, and one ranging from the transition altitude down to the final step altitude using the BADA CAS. The primary difference between those two steps is the velocity used. If the Mach transition altitude is not crossed during the step, then the step is not split.

For descent steps, the following is the methodology for how the step is calculated. First, based on if the step is starting above the Mach transition altitude or not, it is determined if BADA CAS or BADA constant Mach should be the speed used for the descent step.

Next, the aircraft headwind is calculated. This is done by finding the heading of the current track segment and taking the projection of the headwind, which is altitude dependent. The heading of the current track segment is found by converting the latitude and longitude of the endpoints of the track segment into a planar X-Y coordinate system via a geographic projection system. The X-Y coordinate system has its origin at the start point of the track segment, so finding the unit vector of the track segment is done by normalizing the X and Y components of the segment end point. That unit vector is then multiplied by the magnitude and vector of the headwind, resulting in the projection of the headwind vector onto the track segment vector.

AEDT calculates the  $dh/dt$  climb rate term of the force balance equation by dividing the change in altitude of the segment by the product of the segment length divided by the total segment speed (BADA speed – headwind).



---

Finally, AEDT calculates the energy share factor for the altitude region in which the step takes place. Once all of the terms on the right-hand side of Eq. 3-163 are known, the thrust for the step is calculated.

#### 3.9.1.7.3.2 Decelerating Descent Steps

Decelerating descent steps are used to bridge the speed differences between the Doc 9911 and BADA models. These steps both descend to the next MSL altitude control as well as decrease the aircraft's speed. This is done by substituting different end speed values than those dictated by the BADA CAS schedule. Other than that, they act like normal descent steps. Note that this step could be interpreted as a "transition" between the two performance specifications models, as it begins on the BADA speed schedule and ends with a state computed using Doc 9911 analysis.

Once the descent step has been modeled, a fixed trajectory point is populated with the final altitude, the thrust for the step, the speed traveled during the step, the horizontal track distance of the step, operation mode type, and point number.

The thrust is then converted from raw force units to corrected net thrust per engine.

#### 3.9.1.7.4 Overflight Operations

Overflight operations in BADA are less restricted than approaches and departures in terms of the steps they can process. Specifically, overflights are able to model ascending or descending altitude controls in any order required by using climb and descend steps respectively.

Due to the flexible nature of the trajectories overflights can be assigned to, AEDT uses BADA for any modeled altitudes at or above 10,000 ft MSL and Doc 9911 for any altitudes below 10,000 ft MSL. Overflights that have two controls that span the 10,000 ft altitude will use each model for their respective portions of the track between those two controls.

Overflight modeling consists of a similar iterative process that approaches and departures perform. The next track segment with an altitude control is identified as the current segment, and the next altitude control following that segment is identified as the target. If the target altitude control altitude is higher than the current altitude by more than 100 ft, a climb step is called, as described below. If the next target is lower than the current altitude by more than 100 ft, a descend step is called as described in Section 3.9.1.7.3.1. If neither of those step types are called, a cruise step is modeled.

##### 3.9.1.7.4.1 Climb Steps

When calculating a climb step, first a determination must be made regarding in which altitude region the step is taking place. If the step will cross the Mach transition altitude, the step will be split into two pieces, one going from the starting step altitude leading up to the Mach transition altitude, and one ranging from the transition altitude to the final step altitude. The primary difference between those two steps is the velocity used. If the Mach transition altitude is not crossed during the step, then the step is not split.

For climb steps, the following is the methodology for how the step is calculated. First, based on if the step is starting above the Mach transition altitude or not, it is determined if BADA CAS or BADA constant Mach should be the speed used for the climb step.

Next, the aircraft headwind is calculated. This is done by finding the heading of the current track segment and taking the projection of the headwind, which is altitude dependent.

The heading of the current track segment is found by converting the latitude and longitude of the endpoints of the track segment into a planar X-Y coordinate system via a geographic projection system. The X-Y coordinate system has its origin at the start point of the track segment, so finding the unit vector of the track segment is done by normalizing the X and Y components of the segment end point. That unit vector is then multiplied by the magnitude and vector of the headwind returned by the Weather Module, resulting in the projection of the headwind vector onto the track segment vector.

The  $dh/dt$  climb rate term of the force balance equation is calculated by dividing the change in altitude of the segment by the product of the segment length divided by the total segment speed (BADA speed – headwind).

Finally, the energy share factor is calculated for the altitude region in which the step takes place. Once all of the terms on the right-hand side of Eq. 3-163 are known, the thrust for the climb step is calculated.

#### 3.9.1.7.4.2 Climb Step Post-Processing

Once the climb step has been modeled, a fixed trajectory point is populated with the final altitude, the thrust for the step, the speed traveled during the step, the horizontal track distance of the step, operation mode type, and point number. The thrust is then converted from raw force units to corrected net thrust per engine via the following:

$$\frac{F_n}{\delta} = \frac{F/N}{\delta} \quad \text{Eq. 3-178}$$

where

$\delta$	Atmospheric pressure ratio;
$F$	Total thrust; and
$N$	Number of engines.

If the thrust type is Percent, then the noise thrust is calculated as a percentage of static thrust, as discussed in Section 3.6.2.2.

Once the thrust has been converted, the trajectory point is then added to the end of the existing list of trajectory points.

#### 3.9.1.7.4.3 BADA Thrust Limits

Once the thrust for the step has been determined, it is compared to the maximum achievable thrust the aircraft can produce at the MSL altitude at which it is currently flying.

If the thrust needed to perform the climb step is greater than the maximum thrust the aircraft has available, the step is recalculated, with the aircraft flying at max thrust in an attempt to see how high it can climb over the course of track segment. The MSL altitude achieved in this recalculation is then compared to the requirements of the altitude control.

To find the maximum achievable MSL altitude, a convergence loop is established in which the end altitude is varied and the thrust calculated as with a normal climb step. The convergence is achieved when the calculated thrust is less than 1/1,000,000 Newtons less than maximum thrust. The altitude used on the iteration when that convergence criterion is achieved is the maximum achievable altitude.

If the maximum achievable altitude loop is unable to find a point of convergence, a secondary backup loop is initiated, where in each iteration, the final altitude is lowered from the previous target in 100 ft increments, starting at the original altitude control altitude. This loop replicates the climb step, with the exception of the exit criteria, which remains the same as the convergence loop.

If neither the convergence loop nor the secondary backup loop are able to find a satisfactory maximum achievable altitude, an exception is generated.

Once an achievable maximum MSL altitude is determined, that altitude is compared to the criteria set forth by the altitude control. Additionally, AEDT allows for a 300 ft tolerance on either side of an altitude control altitude when checking if an altitude control has been satisfied. Specifically:

- If an achieved altitude is within 300 ft above or below an At type altitude control altitude, it is acceptable and within allowed tolerances.
- If an achieved altitude is below or within 300 ft above an AtOrBelow type altitude control altitude, it is acceptable and within allowed tolerances.
- If an achieved altitude is above or within 300 ft below an AtOrAbove type altitude control altitude, it is acceptable and within allowed tolerances.

If the maximum achieved altitude is found to be within allowed tolerances, it is returned as the final altitude for the climb step.

#### 3.9.1.7.4.4 Cruise Steps

Cruise steps follow the same force balance as the rest of the BADA steps, given in Eq. 3-163. However, the starting and ending altitudes of the step are equal, so thrust is equal to drag as given in Eq. 3-161. Cruise steps also have a slightly different limitation on thrust than climb steps. Specifically, maximum cruise thrust is set by BADA at 95% of maximum climb thrust.

For cruise segments longer than 10 nmi for which there is no change in altitude, a thrust transition segment is added after the first 1,000 ft of the segment. The purpose of these segments is to allow for any thrust or speed transitioning that may occur between a previous climb or descend step and the current level step.

### 3.9.2 Sensor Path Flights

For advanced users pursuing complex use cases (e.g., research or simulations), AEDT supports trajectory specification for full flight runway-to-runway operations in the form of sensor path data. Each data sample specifies a location and speed – either groundspeed (kts), true air speed (KTAS), calibrated air speed (KCAS), or MACH. The calculated performance result will tend to conform to these inputs, subject to the constraints of the performance model. The performance calculations for runway-to-runway operations proceed as follows:

- The input flight path is smoothed and filtered.
- The terminal-area departure portion of the operation is calculated.

- The en-route portion of the operation is calculated.
- The terminal-area approach portion of the operation is calculated.

Note that a particular sensor path operation might never reach 10,000 ft AFE, in which case the distance-weighted average altitude of the sensor path with respect to sea-level provides the dividing line at each end.

### 3.9.2.1 Preliminary Processing

First, before any preprocessing is performed on the original sensor path data, the horizontal length is calculated by integrating great circle path lengths between points. This is used to choose an appropriate standard profile by stage length for the terminal-area portion of the operation (see Table 11-16 or Table 11-30 for details on the correspondence between horizontal distance and stage length).

AEDT smooths and applies filters to the MSL altitude and speed profiles implied by provided sensor path data. The user has the option whether or not the filtering will be applied. All samples preceding the first sample above 500 ft AFE at the departure airport, and all samples following the last sample above 500 ft AFE at the arrival airport, are discarded. Sensor path samples are discarded where the magnitude of acceleration to or from an adjacent sample exceeds the global longitudinal acceleration limit imposed by BADA. Samples for which the change in climb angle exceeds the BADA normal acceleration limit are also discarded. Exponential smoothing is applied to the remaining altitude and speed profiles in the forward and reverse directions. This results in the “trusted” path.

AEDT separates the trusted path into its phases. There can be up to five phases: terminal area-departure, enroute climb-out, enroute cruise, enroute descent, and terminal-area arrival. Three key altitudes are calculated to aid in this separation:

- Cruise Altitude is a distance-weighted average of the target MSL altitudes.
- Departure Top Altitude is the altitude at which Doc 9911-based calculations are intended to end and give way to BADA-based modeling. It is the lesser of:
  - 10,000 feet above the departure airport, and
  - Cruise Altitude
- Arrival Top Altitude is the altitude at which Doc 9911-based calculations recommence. It is the lesser of the following two quantities:
  - 10,000 feet above the arrival airport
  - Cruise Altitude

Using these altitudes, the trusted path is separated as follows:

- The terminal-area departure phase consists of all points preceding the point where the altitude reaches the departure top altitude.
- The en-route climb phase consists of all points from where the departure top altitude is first reached to where the cruise altitude is first reached.
- The en-route cruise phase consists of all points from where cruise altitude is first reached, to where cruise altitude is last reached.

- The en-route descent phase consists of all points from where cruise altitude is last reached, to where the arrival top altitude is last reached.
- The terminal-area arrival phase consists of all points from where the arrival top altitude is last reached, and all subsequent points.

A final filtering step, which we refer to as “super-segmentation”, is applied to each phase. This process begins by identifying points for which acceleration is equal to the average acceleration for the phase, or for which climb angle is equal to 130% or 70% of the average climb angle in the phase. Points which meet any of these criteria are termed super-segmentation control points. Points which aren’t super-segmentation control points have their altitude and speed values modified according to interpolation of the altitudes and speeds at super-segmentation control points.

From this point, the smoothed, filtered, separated, and super-segmented points constitute target states for subsequent performance analysis.

### 3.9.2.2 Terminal Area

AEDT internally defines terminal-area operations for the departure and approach phases. Each of these operations contains a pointwise ground track based on the pre-processed sensor path data. For each target from the departure and en-route phases, the track for the departure operation has one track point with the same surface coordinate. In cases where the target is a super-segmentation control point, the corresponding track point has an MSL altitude control of type “At or below”, targeting the altitude of the control point. The track for the approach operation is constructed similarly, except that only targets from the approach phase are used. Altitude controls are then forced to be monotonically increasing (for departures) or decreasing (for approaches).

AEDT processes performance for the two terminal-area operations as described in Section 3.9.1. The departure operation is processed first. The portion of that operation’s performance up to where the departure top altitude is first reached (interpolating as needed) is kept as the departure performance. Then, AEDT processes performance for the en-route phases (described in the next section), and the approach operation. The final point in the result of each phase informs the initial point of the next phase, and all results are combined into a complete runway-to-runway result. Note that since the terminal area portion of sensor path analysis is performed using altitude controls, terminal area speeds are determined by the standard procedural profile, and sensor path speeds in the terminal area do not inform the performance results.

If the controls-agnostic flight path created for the departure phase had a BADA 3 climbout that started below the lesser of the departure top altitude and the cruise altitude, then the point where the aircraft reaches that BADA 3 climbout altitude is the departure Doc9911-BADA3 transition point, and any discontinuities that occur there are smoothed over the entire right segment (the first BADA3 best-effort step to reach a target point). Otherwise, the point where the aircraft reaches 10,000 ft AFE for the departure airport is the departure Doc9911-BADA3 transition point, and any discontinuities that occur there are smoothed over the entire left segment (the final Doc 9911 step).

### 3.9.2.3 En-route Phase Overview

After the final state of the aircraft has been determined for the departure phase, performance calculations are performed for en-route phases. AEDT calculates performance for each en-route phase of targets in turn, using the final state of any given phase as the initial state of the subsequent phase. Note that when the computed departure phase extends beyond a given phase of en-route targets, performance analysis for that phase of targets is skipped.

Performance for an en-route phase of targets begins from the final state of the preceding computed phase. From there, a performance segment is computed for flight to the first target that follows. This is repeated for all subsequent targets in the phase.

### 3.9.2.4 En-route Performance Segment Calculation

En-route performance segments are computed for each target. AEDT calculates the segment such that it comes as close as possible to the target state, subject to the performance limitations of the aircraft, and prioritizing the target altitude<sup>xv</sup> over the target ground speed. For each segment of an en-route phase, the initial point is taken from the final point of the previous segment. This includes the initial altitude,  $h_i$ . All calculations to determine the final point are based on the initial time and initial aircraft weight. The final geographic coordinate is known from the sensor path specification, and as a result, the segment's horizontal length is known.

The final point of a segment is first limited by BADA envelope considerations. First, the envelope-limited final altitude,  $h_f^{(1)}$ , is determined by limiting the final altitude,  $h_f^{(0)}$ , specified in the sensor path by the maximum final altitude,  $h_{fmax}$ , with the aircraft mass taken from the initial point, and the temperature deviation sampled at the initial time and final geographic coordinate, at sea level. AEDT then determines the envelope-limited final groundspeed,  $V_{Gf}^{(1)}$ , by limiting the final groundspeed,  $V_{Gf}^{(0)}$ , specified in the sensor path by the minimum final calibrated airspeed,  $V_{min}$ , and by the BADA aircraft's maximum operating CAS,  $V_{MO}$ . Note that all comparisons between groundspeed, true airspeed, and calibrated airspeed are performed in the context of the envelope-limited final altitude,  $h_f^{(1)}$ .

Next, the BADA longitudinal acceleration limit is applied to the final groundspeed of the segment. The acceleration-limited final groundspeed,  $V_{Gf}^{(2)}$ , is initialized to the envelope-limited final groundspeed,  $V_{Gf}^{(1)}$ , and then limited by iteratively decrementing (or incrementing, as appropriate) by one foot per second until it satisfies:

$$\left| V_{Gf}^{(2)} - V_{Gi} \right| \leq \frac{a_{l,max(civ)} \sqrt{L_h^2 + (h_f^{(1)} - h_i)^2}}{\frac{1}{2} (V_{Gf}^{(2)} + V_{Gi})} \quad \text{Eq. 3-179}$$

<sup>xv</sup> Aircraft operating over 18,000 feet MSL fly according to flight levels, which are based on pressure altitudes, not MSL altitude. If en-route operations assume an ISA atmosphere, then pressure altitude is same as MSL altitude.

where

$h_i$	Initial altitude (m);
$h_f^{(1)}$	Envelope-limited final altitude (m);
$V_{Gf}^{(2)}$	Acceleration-limited final groundspeed (m/s);
$V_{Gi}$	Initial groundspeed (m/s);
$L_h^2$	Segment horizontal length (m); and
$a_{l,max(civ)}$	Maximum longitudinal acceleration for civil flights.

The maximum allowed change in climb angle,  $\Delta\gamma_{max}$ , from the previous segment's climb angle is calculated by:

$$\Delta\gamma_{max} = \frac{a_{n,max(civ)} \sqrt{L_h^2 + (h_f^{(1)} - h_i)^2}}{\left[ \frac{1}{2} (V_{Gf}^{(2)} + V_{Gi}) \right]^2} \quad \text{Eq. 3-180}$$

where

$a_{n,max(civ)}$	Maximum normal acceleration for civil flights.
------------------	--

The acceleration-limited final altitude,  $h_f^{(2)}$ , is adjusted such that the climb angle,  $\gamma$ , does not differ from the previous segment's climb angle by more than this amount.

After limiting is complete, segment duration  $\Delta t$  (s) is calculated from:

$$\Delta t = \frac{\sqrt{L_h^2 + (h_f^{(2)} - h_i)^2}}{\frac{1}{2} (V_{Gf}^{(2)} + V_{Gi})} \quad \text{Eq. 3-181}$$

where

$h_f^{(2)}$	Acceleration-limited final altitude (m).
-------------	--

Acceleration  $a$  (m/s<sup>2</sup>) is calculated from:

$$a = \frac{V_{Gf}^{(2)} - V_{Gi}}{\Delta t} \quad \text{Eq. 3-182}$$

and the climb rate from:

$$\frac{dh}{dt} = \frac{h_f^{(2)} - h_i}{\Delta t} \quad \text{Eq. 3-183}$$

Drag is calculated as outlined in Section 3.9.1.7.1.4, and total net thrust is calculated according to Eq. 3-162, with the appropriate speed and density choices (initial values for initial thrust, final values for final thrust).

If the final thrust exceeds the maximum climb thrust (as evaluated at the final location) by more than 20%, then thrust limiting is applied. Here, the final speed is iteratively decremented, one knot at a time. With each iteration, the final thrust is recalculated in the same manner as originally calculated. Iteration continues as necessary until the final thrust is within limits, or until the final speed falls below either the initial segment speed or the stall CAS. If the final thrust still exceeds the limit, the final altitude is recursively bisected between the initial altitude and the final altitude until the interval is less than one foot. If the bisection method does not find an altitude that satisfies the thrust limits, the final altitude is set to the initial altitude; then checked if thrust limits are satisfied. If the final thrust still exceeds the limit, the air operation is rejected, and an error message is logged.

At this point, there is enough information available to calculate the segment fuel flow and fuel burn, along with the change in weight. Note that the initial thrust calculated for the segment overrides the final thrust calculated according to the previous segment.

AEDT supports user-specified altitude and groundspeed deviation warning tolerances. The user can specify an altitude warning tolerance and/or a speed warning tolerance. Whenever a computed altitude or groundspeed differs from the target value by more than the tolerance (if specified), AEDT logs a warning to the user.

#### **3.9.2.5 Sensor Path Processing with BADA 4**

In addition to processing sensor path trajectory data using Doc 9911/BADA 3 methods, BADA 4 methods can also be used to model aircraft performance from sensor path trajectory data in a similar manner. Refer to the “AEDT sensor path methods using BADA4” report<sup>25</sup> for documentation on general techniques of using BADA 4 data and method in AEDT with sensor path trajectory data.

The BADA 4 sensor path methods have been modified from the methods described in the “AEDT sensor path methods using BADA 4” report. In that document, and in versions of AEDT prior to 3c, the method of determining the BADA 4 aircraft configuration schedule used only the aircraft altitude (see *Section 4 Flaps and slats issues* in the report). AEDT now uses a combination of AFE altitude and KCAS information and ANP procedure data – when available – to provide a more realistic high-lift deployment schedule for BADA 4 sensor path operations.

During arrivals, the BADA 4 aircraft are initially modeled in one of three configurations: cruise, approach, and landing. Above the approach configuration AFE altitude, the aircraft remains in the cruise configuration, regardless of airspeed. Below the approach configuration altitude, and above the landing configuration altitude, the BADA 4 aircraft will transition to the approach configuration when the calibrated airspeed falls below the minimum calibrated airspeed for the cruise configuration plus an airspeed safety margin. Below the landing configuration altitude, the BADA 4 aircraft will transition to the landing configuration when the calibrated airspeed drops below the approach configuration airspeed plus an airspeed safety margin. This method of assigning arrival configurations is shown schematically in Figure 3-26 below. Each datum in the method (e.g., the landing configuration airspeed)



may be unique to the particular BADA 4 aircraft, and may be affected by the weight of the aircraft, the local atmospheric conditions, and the bank angle of the aircraft.

The current calibrated airspeed of the aircraft is then compared to the airspeeds in the associated ANP aircraft's standard arrival profile. If the ANP procedure step which encompasses the current sensor path point's airspeed contains a flap configuration that is 'dirtier' (i.e., a higher flap/slat deployment, so that the 'R' drag-over-lift coefficient is higher) than the current associated BADA 4 high-lift configuration, then the aircraft configuration is changed to the flap configuration of that ANP procedure step. If the ANP procedure step which encompasses the current sensor path point's airspeed contains flap configuration data that is the same as the current configuration, 'cleaner' than the current configuration, or does not exist (as is the case with ANP procedure steps where idle thrust is used), then the BADA 4 high lift configuration is unchanged from that in the prior sensor path point.

The logic in the prior two paragraphs allows the BADA 4 sensor path aircraft to follow the high lift configuration of the ANP procedure steps based on calibrated airspeed when the ANP arrival data exist, to follow the BADA 4 high-lift configuration methods based on airspeed and AFE altitude when the ANP data do not exist, and to maintain a logical progression of high-lift deployment when the ANP procedure profile does not contain complete flap deployment information.

Note that the AEDT BADA 4 sensor path methods do not allow a change to a 'cleaner' configuration on approach once a 'dirtier' configuration has been selected.

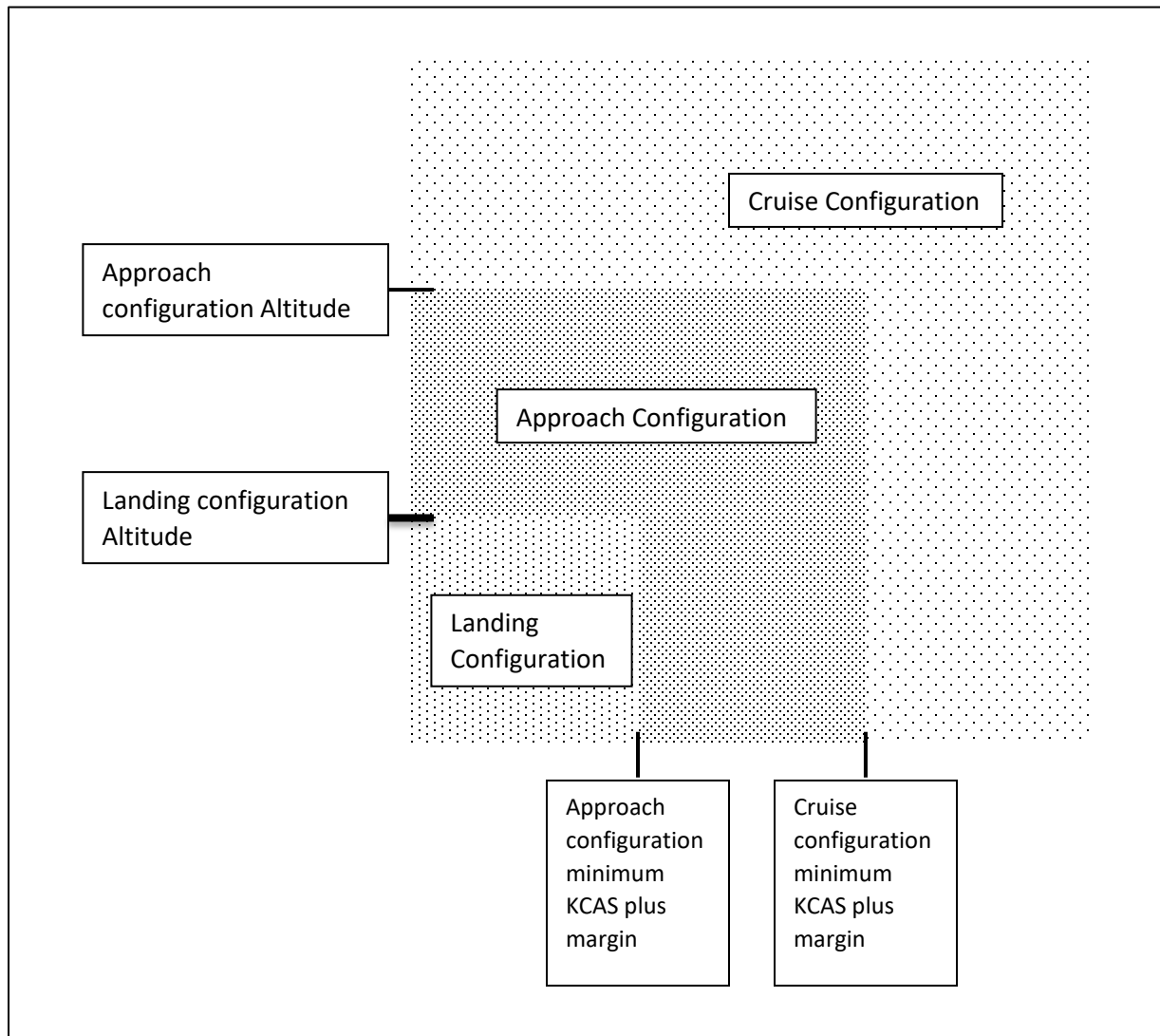

Figure 3-26 Schematic of BADA 4 Sensor Path Arrival Configuration Schedule

### 3.10 Noise Mode

Performance calculations in AEDT include the determination of which NPD curve to use in noise calculations (discussed in Section 4). This determination is made for each individual trajectory segment. For helicopters, there is an NPD curve associated with each type of procedure step. Thus, each trajectory segment is assigned the NPD curve that corresponds to the type of procedure step undergone during that segment. For airplanes, all trajectory segments outside of the terminal area are assigned departure mode. Airplane segments in the terminal area that originate from explicit fixed-point profiles are assigned the NPD curve that is assigned to the nearest fixed-point at or preceding the trajectory segment. Airplane segments in the terminal area that originated from any other treatment are assigned departure mode if they are climbing, accelerating at constant altitude, or applying reverse thrust during ground roll; approach mode is assigned otherwise. The particular performance model used to generate the performance result does not influence the assigned NPD curves.

For airplanes using control points, the last control point in the en-route region of the track ends the performance result. This remains true even if the airplane’s original procedure profile contains steps with altitudes higher than the control point(s); those higher procedure steps are discarded from the performance result.

When the performance result ends, noise at the receptor locations past the ending of the performance result (i.e., receptors farther from the runway end associated with the track) will be calculated; only those segments prior to the end of the performance results will contribute noise energy to those receptors. This is similar to how noise is calculated past the ending of a standard (i.e., non-control) profile.

For example, consider an AtOrBelow control point inserted into a departure track far enough from the runway such that the modeled aircraft can climb to the control altitude without failing the restriction tests. In the example below in Figure 3-27, the sample control point at segment 10 has an altitude of 18,000 feet MSL at a location of 42.35 latitude, -70.1 longitude. Note that the modeled track extends due East from the initial point at 42.53 latitude, -71 longitude at the start of a user-defined runway.

Segment Number	Latitude (deg)	Longitude (deg)	Altitude MSL (ft)	Altitude Control
1	42.35	-71		None
2	42.35	-70.9		None
3	42.35	-70.8		None
4	42.35	-70.7		None
5	42.35	-70.6		None
6	42.35	-70.5		None
7	42.35	-70.4		None
8	42.35	-70.3		None
9	42.35	-70.2		None
10	42.35	-70.1	18000	At or Below
11	42.35	-70		None

Figure 3-27 Example of an AtOrBelow Control Point at Segment Number 10

An airplane using this track (“10dep\_18alt” in Figure 3-27) will have its procedure profile extended to include the (possible) acceleration to the BADA 3 KCAS climb speed, and climb to the control point altitude. Continuing this example, Figure 3-28 below shows the altitude performance result for an airplane using this track. In this case, the airplane’s BADA 3 en-route KCAS (300 KCAS) is greater than the

airplane’s final Doc 9911 KCAS (250 KCAS), so the airplane accelerates after the end of the terminal area (10,000 feet AFE) to the BADA 3 climb KCAS. After accelerating to the BADA 3 climb KCAS, the airplane climbs at a rate which intercepts the control point.

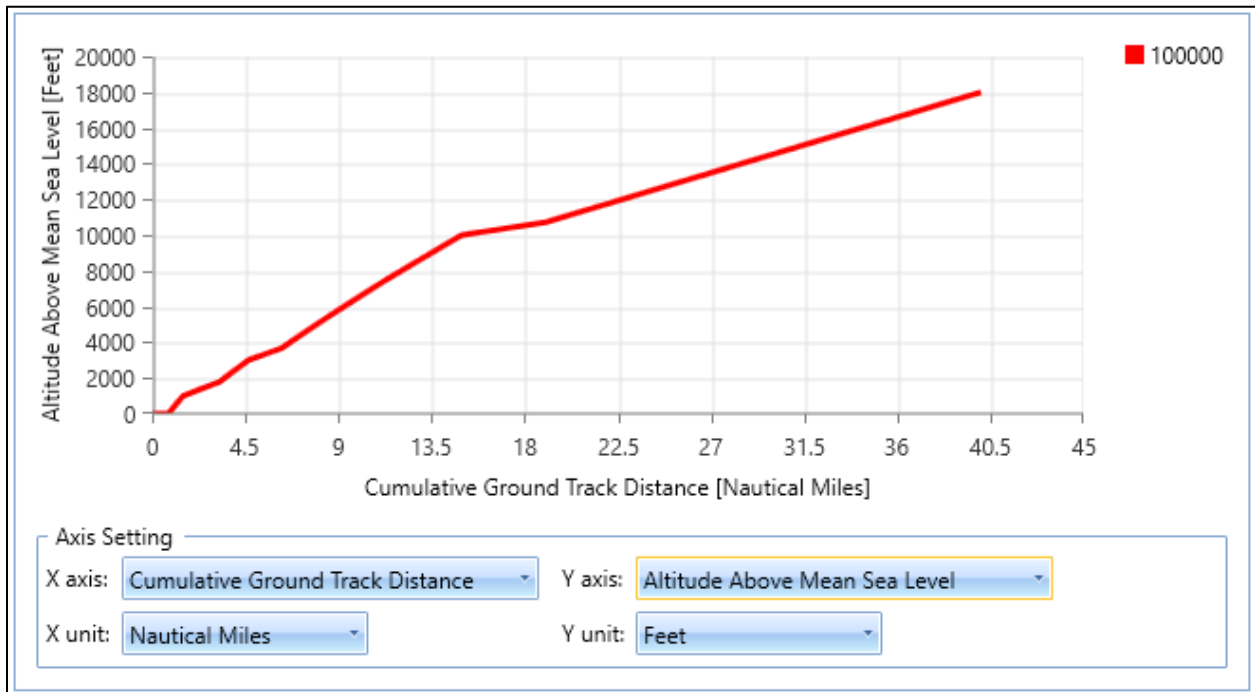

Figure 3-28 Example of the Altitude Performance Result for an Airplane Modeled with the Track from Figure 3-27

For this example flight, the performance result ends at a track distance of about 40 miles from the start of the takeoff roll, but the noise produced by this flight extends beyond the end of the performance result. Figure 3-29 below shows the noise under the flight track as a function of the track distance from the start of the takeoff roll. At 40 nm, the noise from this modeled operation significantly decreases due to the ending of the performance result. AEDT continues to calculate noise past the end of the performance result. In the Figure 3-29 below, the calculated noise ends at about 80 nm because that is where the receptor set ends.

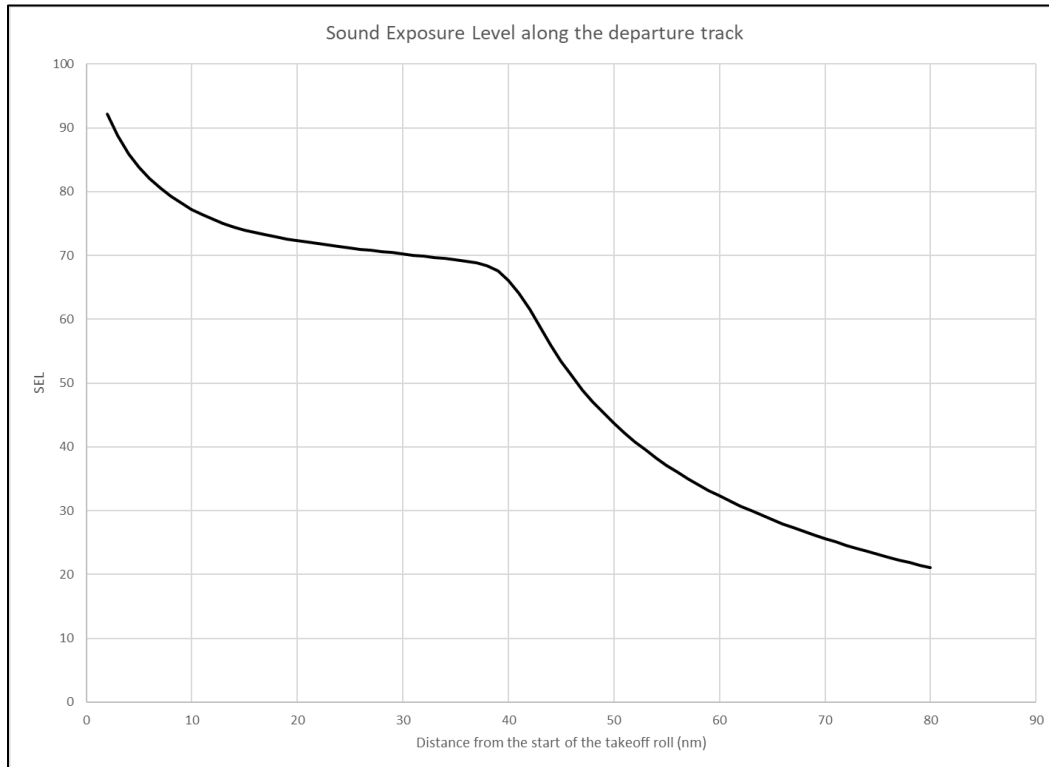

Figure 3-29 SEL as a Function of the Track Distance for the Example Operation

### 3.11 Insertion at Significant Altitudes

Interpolated performance states at altitudes that are significant to emissions and acoustics analyses are inserted into a computed performance trajectory.

#### 3.11.1 Noise Cutoff Altitude

The noise cutoff altitude is an altitude (in feet MSL) above which a flight trajectory's contributions to noise are meant to be excluded. If a noise cutoff altitude is specified, any trajectory segment that crosses the noise cutoff altitude gets split into two segments at the point of that crossing. Then, when noise is computed, the noise contribution of any segment with any content above the cutoff altitude (after the aforementioned splitting) is excluded.

Note that under Doc9911-BADA4 analysis, splitting at the noise cutoff altitude is not performed for segments that begin or end within 0.1 feet of the noise altitude cutoff altitude, nor for any segments in the case of sensor path analysis.

#### 3.11.2 Mixing Height

The mixing height is the AFE altitude (feet) above which the emissions produced by an aircraft no longer contribute to emissions dispersion calculations. The BADA 4 profile-driven algorithm inserts an interpolated performance state at an altitude equal to the mixing height (if a performance state is not already present within 0.1 feet of altitude of the mixing height). Furthermore, the performance

algorithm calculates the total duration of time that an aircraft trajectory spent below the mixing height. This is accomplished by summing the duration of each segment that starts below the mixing height.

### 3.11.3 Altitude Intervals

In order to ensure that no single climbing or descending segment within a computed performance trajectory is excessively long, the BADA 4 performance algorithm inserts an interpolated performance state at each 1,000-foot (MSL) interval of altitude. Similar insertions are made at 2,000 ft (MSL) intervals in profile-driven Doc9911-BADA 3 analysis, as well as for air operations with track controls.

## 3.12 Use Case of Track Altitude Control at 18,000 ft MSL

Extending the flight standard departure or arrival procedural profile up to 18,000 ft MSL is commonly done for the purpose of generating DNL contours for the 45 DNL dB level and below.

A sample use case is using a single “At” track altitude control with the target altitude of 18,000 ft MSL in order to extend a procedural profile. AEDT implementation of track control flights is summarized as follows for this use case. For detailed description of trajectory-driven flight performance, please refer to Section 3.9.1.

1. AEDT calculates the flight path from the procedure profile as though there are no altitude controls.
2. In case of a departure operation, the aircraft follows the procedural profile to below 10,000 ft MSL altitude. At and above 10,000 ft MSL, obedience to the instructions of the ANP procedure steps is abandoned, and the departure operation will instead fly under the instructions of the BADA procedures until it reaches the terminal altitude limit.
  - a. In case of Doc 9911 performance modeling, the terminal altitude limit is defined by the last climb procedure step. Details of the respective BADA 3 modeling algorithms are described in Section 3.6.2.8.
  - b. In case of BADA 4 performance modeling, the terminal altitude limit is defined as 10,000 feet above the departure runway end (ARE). Details of the respective BADA 4 modeling algorithms are described in Section 3.7.7.
3. In case of an arrival operation, the procedural flight path is calculated based on the instructions of the respective procedure steps. The 10,000 foot MSL restriction on the usage of the instructions of the ANP procedure steps is not implemented for the arrival operations.
4. This “standard” departure or arrival flight path, is then modified to match the target altitude of 18,000 ft MSL. Either BADA 3 or BADA 4 performance model is used to reach the target altitude, depending on which performance model was selected by the user for the given flight.

The NPD selection is based on the segment’s Noise Operation Mode which is assigned as described in Section 3.10, regardless of the aircraft performance model being used.

## 4. Noise

AEDT computes noise from a series of individual aircraft operations (known as single-event noise), and then accumulates these single-event noise levels across all of the events in an AEDT study into cumulative noise levels for the study. This is done according to the steps below:

1. Accept aircraft-specific data (equipment, noise, position, and operational data) and study-specific data (weather, terrain, boundary, or ambient data) as input (see Sections 2.2 and 4.1);
2. Determine the unadjusted noise values at the receptors (see Sections 4.2.1 and 4.2.2);
3. Apply adjustments to account for environmental, meteorological, operational and position effects (see Sections 4.3, 4.4, and 4.5);
4. Compute the single-event base metrics at the receptors (see Sections 4.6.1, 4.6.2, 4.6.3, and 4.6.4);
5. Repeat steps one through four for each unique, single event in the AEDT study;
6. Accumulate the noise output and compute the appropriate noise metrics (see Section 4.6.5); and
7. Annualize noise results (see Section 8).

Figure 4-16 and Figure 4-17 graphically summarize the acoustic computation process employed in AEDT.

Figure 4-18 graphically summarizes the accumulation of noise metric computation process.

The noise, aircraft flight profile and flight path computation methodologies implemented in AEDT Version 3g are compliant with:

- The International Civil Aviation Organization (ICAO) Doc 9911 (2nd Edition, 2018), “Recommended Method for Computing Noise Contours Around Airports”<sup>67</sup>; and
- The European Civil Aviation Conference (ECAC) Doc 29 (4<sup>th</sup> Edition, 2016) “Report on Standard Method of Computing Noise Contours around Civil Airports”<sup>70</sup>.

### 4.1 Flight Path Segment Parameters

As a prerequisite to noise level computations, AEDT computes several geometric and physical parameters associated with an aircraft flight path. This section describes the computation of these parameters.

Computation of the following flight-segment geometric parameters is presented in Section 4.1.1:

- The closest point of approach on the flight path segment, or the extended flight path segment, to the receptor; and
- The slant range from the receptor location to the closest point of approach.

Computation of the following flight-segment geometric and physical parameters is presented in Section 4.1.2:

- The speed along the flight path segment;
- The AGL altitude associated with the flight path segment;
- The over-ground, sideline distance from the receptor location to the ground-projection of the closest point of approach; and
- The engine power associated with the flight path segment.

Figure 4-1 through Figure 4-3 present, respectively, the receptor/flight-segment geometry for the three general AEDT cases:

- The receptor is behind the flight path segment (Figure 4-1)
- The receptor is astride the flight path segment (Figure 4-2)
- The receptor is ahead of the flight path segment (Figure 4-3)

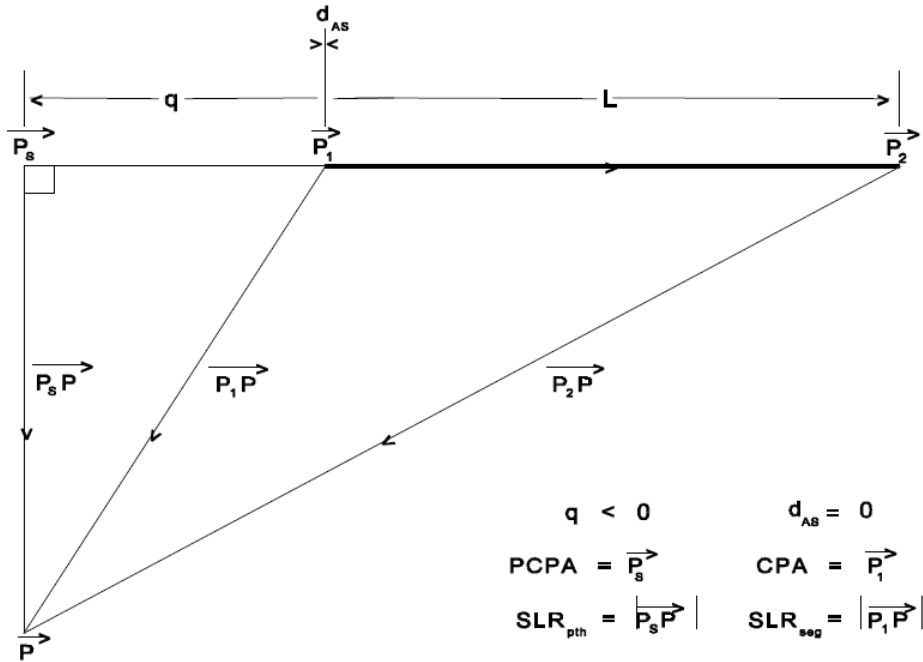

Figure 4-1 Flight-Segment Geometry when a Receptor Is Behind a Segment



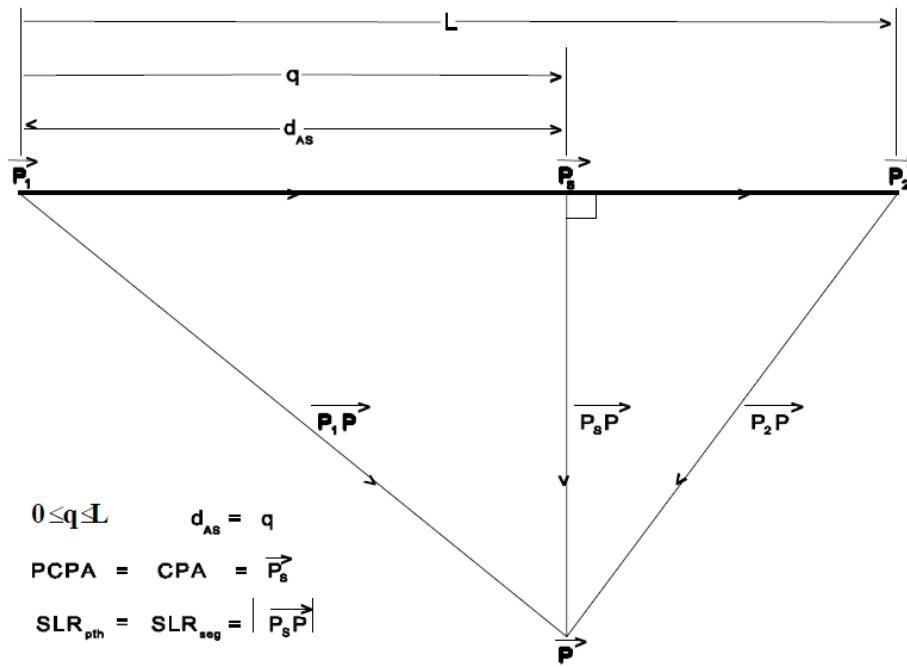

Figure 4-2 Flight-Segment Geometry when a Receptor Is Astride a Segment

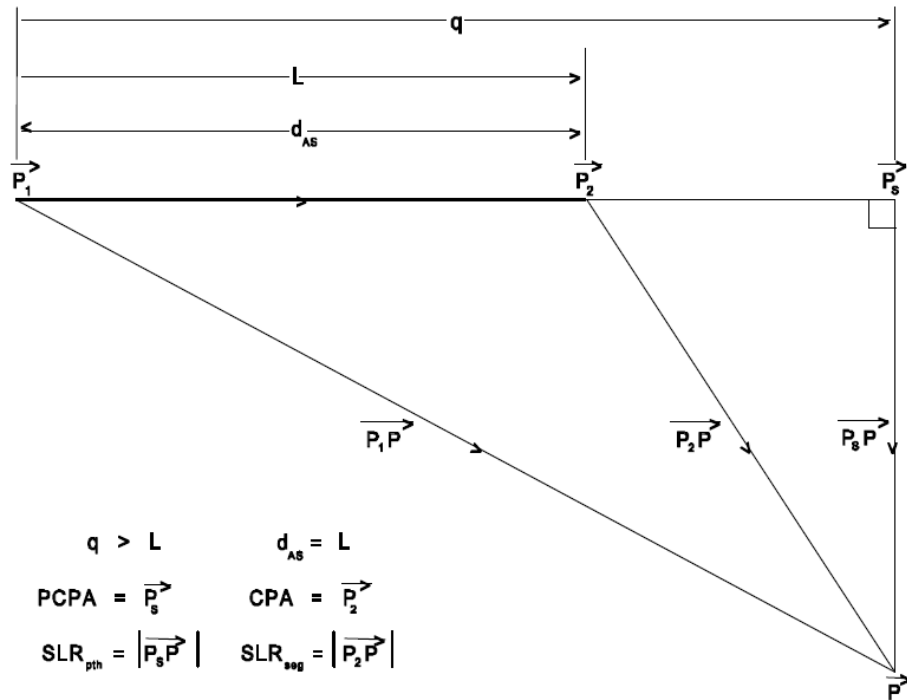

Figure 4-3 Flight-Segment Geometry when a Receptor is Ahead of a Segment

The variables shown in Figure 4-1 through Figure 4-3 are defined as follows:

P      Receptor point

$P_1$	Start-point of the flight path segment
$P_2$	End-point of the flight path segment
$P_s$	PCPA, the point on the flight path segment, or the extended flight path segment, which is the perpendicular closest point of approach to the receptor, as defined in detail in Section 4.1.1, below. The specific definition depends on the position of the receptor relative to the flight path segment.
$P_1P_2$	Vector from the start of the flight path segment to the end of the flight path segment. It has a minimum length of 10 ft.
$P_1P$	Vector from the start of the flight path segment to the receptor. It has a minimum length of 1 ft.
$P_2P$	Vector from the end of the flight path segment to the receptor. It has a minimum length of 1 ft.
$P_sP$	Perpendicular vector from the receptor to PCPA on the flight path segment, or the extended flight path segment, as defined in detail in Section 4.1.1. It has a minimum length of 1 ft.
$SLR_{pth}$	$ P_sP $ , the length of the perpendicular vector from the receptor to PCPA on the flight path segment, or the extended flight path segment as defined in detail in Section 4.1.1. It has a minimum length of 1 ft.
$L$	Length of the flight path segment. It has a minimum length of 1 ft.
CPA	Point on the flight path segment, not the extended flight path segment, which is the closest point of approach to the receptor, as defined in detail in Section 4.1.1. The specific definition depends on the position of the receptor relative to the flight path segment.
$SLR_{seg}$	Length of the vector from the receptor to CPA on the flight path segment, not the extended flight path segment, as defined in detail in Section 4.1.1. It has a minimum length of 1 ft.
$q$	Relative distance along the flight path segment, or the extended flight path segment, from $P_1$ to $P_s$ (ft). The value of $q$ is used to determine the position of the receptor relative to the flight path segment, as shown in Table 4-1.
$d_{AS}$	Distance along the flight path segment from the start of the segment at $P_1$ to CPA. Depending on the value of $q$ , i.e., the relative geometry between the receptor and the flight path segment, $d_{AS}$ takes on the values shown in Table 4-1.

Table 4-1 Position of the Receptor Relative to the Flight Path Segment

Value of $q$	Value of $d_{AS}$	Position of Receptor Relative to Flight Path Segment
$q < 0$	0	Receptor is behind segment (Figure 4-1)
$0 \leq q \leq L$	$q$	Receptor is astride segment (Figure 4-2)
$q > L$	$L$	Receptor is ahead of segment (Figure 4-3)

#### 4.1.1 Closest Point of Approach and Slant Range

The closest point of approach and slant range parameters are fundamental to AEDT computations. The slant range is used for noise level interpolation of the NPD data (see Section 4.2.2). In addition, the computation of the closest point of approach and slant range parameters is a prerequisite to the noise

fraction algorithm used for exposure-based metrics (see Section 4.3.3) and for lateral attenuation (see Section 4.3.5).

The slant range from the receptor location to the closest point of approach on the flight path ( $SLR_{pth}$ ) is defined as the distance from the perpendicular closest point of approach (PCPA), on the flight path segment or the extended flight path segment, to the receptor.  $SLR_{pth}$  is used for exposure-based metrics because NPDs represent aircraft data on infinitely long flight paths, and the time-based nature of the exposure-based metrics makes the difference between finite flight path segments (as modeled in AEDT) and infinite flight paths significant. To obtain the noise exposure level due to an aircraft proceeding along a finite flight path segment in AEDT, the exposure-based noise level data must be adjusted by the noise fraction adjustment, which accounts for the geometry difference between  $SLR_{pth}$  and  $SLR_{seg}$ . The specific definition of PCPA depends upon the position of the receptor location relative to the flight path segment. If the receptor is behind or ahead of the flight path segment, then the PCPA is the intersection point of the perpendicular from the receptor to the extended segment. If the receptor is astride the flight path segment, then the PCPA is the intersection point of the perpendicular from the receptor to the segment.

The exceptions to the above definition for slant range occur:

- When the receptor is behind a takeoff ground-roll segment (see Section 4.4.2);
- During runup operations; and
- When performing computations involving  $L_{AS_{mx}}$ ,  $L_{PNTS_{mx}}$ , or time-based metrics.

In these cases, the slant range, designated  $SLR_{seg}$ , is defined as the distance from the receptor location to the closest point of approach on the flight path segment (CPA), not the extended flight path segment. The specific definition of the CPA depends on the position of the receptor location relative to the flight path segment. If the receptor is behind the flight path segment, the CPA is the start point of the segment. If the receptor is astride the flight path segment, the CPA is equivalent to the PCPA. If the receptor is ahead of the flight path segment, the CPA is the end point of the flight path segment.

#### 4.1.2 Speed, Altitude, Distance, and Power

Computations of the following four parameters, associated with each flight path segment, are described in this section.

- The ground speed at the CPA;
- The AGL altitude at the CPA;
- The horizontal sideline distance from the receptor location to the vertical projection of the CPA; and
- The engine power setting (also known as thrust setting) at the CPA.

These computation methodologies are identical for fixed-wing aircraft and helicopters, except for the computation of engine power setting. Engine power setting is fixed for helicopters in AEDT. Therefore, the following engine power setting computation methodology is only applicable to fixed-wing aircraft.

The aircraft speed,  $AS_{seg}$ , at CPA is computed via linear interpolation as follows:

$$AS_{seg} = AS_{p1} + \left[ \frac{\Delta AS}{2} \right] \quad \text{Eq. 4-1}$$

where

$AS_{P1}$  Ground speed at the start of the flight path segment (kts); and  
 $\Delta AS$  Change in ground speed along the flight path segment (kts).

$AS_{seg}$  is used to compute the duration adjustment for exposure-based noise level metrics as presented in Section 4.3.4.

The AGL altitude,  $d_{seg}$ , in ft at the CPA is computed via linear interpolation as follows:

$$d_{seg} = [P_1]_z + d_{AS} \left[ \frac{(P_1 P_2)_z}{L} \right] + h_{terr} - h_{airport} \quad \text{Eq. 4-2}$$

where

$[P_1]_z$  AFE Altitude at the start of the flight path segment, given by the z-component of the vector from the origin of coordinates to the start of the flight path segment (ft above field elevation);  
 $(P_1 P_2)_z$  Change in altitude along the flight path segment (ft);  
 $h_{terr}$  Terrain elevation (ft MSL); when the terrain option is not invoked,  $h_{terr} = h_{aprt}$ ; and  
 $h_{airport}$  Airport elevation (ft MSL).

The sideline distance from the fixed path segment to the receptor,  $l_{seg}$ , defined as the distance in the horizontal plane from the receptor location on the ground to the vertical projection of the CPA, is computed as follows:

$$l_{seg} = (SLR_{seg}^2 - d_{seg}^2)^{1/2} \quad \text{Eq. 4-3}$$

where

$SLR_{seg}$  Length of the vector (ft) from the receptor to CPA on the flight path segment, not the extended flight path segment; and  
 $d_{seg}$  As computed above (Eq. 4-2).

The sideline distance,  $l_{seg}$ , is used to compute the ground-to-ground component of the lateral attenuation adjustment as presented in Section 4.3.5.

For fixed-wing aircraft, the engine power setting,  $P_{seg}$ , at the CPA is computed via linear interpolation:

$$P_{seg} = P_{P1} + \left[ \frac{d_{AS}}{L} \right] \cdot \Delta P \quad \text{Eq. 4-4}$$

where

$P_{P1}$  Engine power at the start of the flight path segment (see Section 2.2.1.1 for units<sup>xvi</sup>); and  
 $\Delta P$  Change in power along the flight path segment.

<sup>xvi</sup> Engine power setting, also known as thrust-setting, is expressed on a per engine basis in a variety of units, including pounds, percent, engine-pressure-ratio (EPR), as well as other units.

$P_{seg}$  is used in performing noise level interpolation as presented in Section 4.2.2<sup>xvii</sup>.

## 4.2 Noise-Power-Distance (NPD) Data Computations

Noise propagation is represented in AEDT with a database of NPD data, which are specific according to aircraft type, aircraft operation type, and noise metric (and, in the case of helicopters, directivity). As described in Section 2.2.1.1, the NPD data for a fixed-wing aircraft in AEDT consist of a set of decibel levels for various combinations of aircraft operational modes (approach, departure, overflight), engine power states and slant distances from receptor to aircraft. Each NPD has noise levels at the following ten AEDT distances: 200; 400; 630; 1,000; 2,000; 4,000; 6,300; 10,000; 16,000; and 25,000 ft. In addition, each set of NPDs include NPDs with the following base noise metrics: SEL, LAMAX, EPNL and PNLTM. When noise data are needed at thrust settings, distances and noise metrics not represented in the NPD data set, they are approximated for the existing NPD database. Section 4.2.1 discusses computations used to approximate base noise metrics, when they are not available in the AEDT database. Section 4.2.2 discusses methods for determining noise levels from the NPD data sets using interpolation and extrapolation.

### 4.2.1 Noise Metric Approximations

In order to compute all of the noise metrics in AEDT from the NPDs in the Fleet database, several noise metric approximations must be made. Section 4.2.1.1 presents methods for computing maximum noise level approximations if the Fleet database does not include maximum noise level NPDs for a particular airframe-engine-engine modification combination. Section 4.2.1.2 presents methods for computing C-weighted noise level approximations from A-weighted NPDs in the Fleet database.

#### 4.2.1.1 Maximum Noise Level Approximation

For several aircraft in the AEDT Fleet database, measured  $L_{ASmx}$  and  $L_{PNTSmx}$  NPD data do not exist, and they are approximated using empirical equations expressed as a function of distance and sound exposure. These equations were developed from a statistical analysis of NPD data for aircraft in which all four base noise level metrics exist in the AEDT database. The equations are as follows:

For civil aircraft:

$$L_{ASmx} = L_{AE} - 7.19 - 7.73 \cdot \log_{10} \left[ \frac{SLR_{pth}}{1,000} \right] \quad \text{Eq. 4-5}$$

$$L_{PNTSmx} = L_{EPN} + 1.22 - 9.34 \cdot \log_{10} \left[ \frac{SLR_{pth}}{1,000} \right] \quad \text{Eq. 4-6}$$

where

- $L_{AE}$  A-weighted sound exposure level (dB);
- $L_{EPN}$  Effective perceived noise level (dB); and
- $SLR_{PTH}$  The length (ft) of the perpendicular vector from the receptor to PCPA on the flight path segment, or the extended flight path segment.

<sup>xvii</sup> The engine power setting for helicopters is an arbitrarily assigned number in AEDT, because the helicopter NPDs are dependent on operational mode, instead of thrust setting. The helicopter engine power setting is determined by  $P_{seg} = P_{p1}$ .

For military aircraft:

$$L_{ASmx} = L_{AE} - 7.84 - 6.06 \cdot \log_{10} \left[ \frac{SLR_{pth}}{1,000} \right] \quad \text{Eq. 4-7}$$

$$L_{PNTSmx} = L_{EPN} + 2.51 - 5.84 \cdot \log_{10} \left[ \frac{SLR_{pth}}{1,000} \right] \quad \text{Eq. 4-8}$$

#### 4.2.1.2 C-Weighted Metric Approximation

C-weighted metrics are calculated using a simplified adjustment procedure, consistent with 14 CFR Part 36<sup>26</sup>, as follows:

1. The aircraft spectral class is used to create two weighted spectral classes: A-weighted and C-weighted;
2. Both weighted spectral classes are corrected back to the source (from the 1,000 ft reference) using SAE-AIR-1845<sup>3</sup>. These are the two weighted source spectra;
3. Each weighted source spectrum is corrected to the 10 standard AEDT NPD distances using the standard AEDT atmosphere (SAE-AIR-1845<sup>3</sup>). This yields 10 A-weighted spectra and 10 C-weighted spectra;
4. The 24 one-third octave band values of each spectrum are logarithmically summed at each AEDT distance, yielding a distance-specific, weighted sound pressure level ( $L_{A,d}$  and  $L_{C,d}$ ). These levels are then arithmetically subtracted for each AEDT distance ( $L_{A,d} - L_{C,d}$ ). This delta represents the difference between an A-weighted metric and a C-weighted metric at each distance; and
5. Each distance-specific delta is applied to the appropriate A-weighted NPD values ( $NPD_{A,d} + (L_{A,d} - L_{C,d})$ ) at the corresponding AEDT distance, resulting in a C-weighted NPD.

#### 4.2.2 Noise Level Interpolation/Extrapolation ( $L_{P,D}$ )

Each aircraft in the modeling layer of the AEDT Fleet database is assigned to an NPD data set that represents the noise levels for a discrete number of operation modes, thrust values, distance values, and metrics. To obtain noise levels that lie between thrust values or between distance values, linear interpolation on thrust and logarithmic interpolation on distance are used. Extrapolation is used to obtain levels outside of the bounding thrust or distance values.

The NPD data are used to either interpolate or extrapolate an associated noise level value. The interpolation/extrapolation is a piecewise linear process between the engine power setting and the base-10 logarithm of the distance.

Since helicopter NPDs are organized by operational mode instead of thrust level in AEDT, an expanded process is utilized for helicopter noise interpolation/extrapolation (Section 4.2.2.4).

##### 4.2.2.1 Standard Noise Level Interpolation/Extrapolation

Interpolation or extrapolation of NPD data for departure operations is performed using the NPD curves designated as departure curves. Similarly, interpolation or extrapolation of NPD data for approach, afterburner or overflight operations is performed using the NPD curves designated as approach, afterburner or overflight curves, respectively.

For each aircraft flight operation, NPD data are available for the four fundamental noise-level metrics,  $L_{AE}$ ,  $L_{EPN}$ ,  $L_{ASmx}$ , and  $L_{PNTSmx}$ . The appropriate metric is selected for interpolation or extrapolation based upon the user-defined noise metric or family of metrics to be computed at the receptor. The specific distance and power value used in the interpolation/extrapolation process is dependent on the type of base metric selected. This section discusses the distance and power values for exposure-based noise-level metrics and maximum noise-level metrics, respectively.

Following is a generalized description of the noise interpolation for an engine power  $P$  and distance  $d$ <sup>xviii</sup>. For this interpolation, the engine power is bounded by NPD curves with engine power  $P_1$  and  $P_2$ . Within these NPD curves, the distance  $d$  is bounded by the NPD distances of  $d_1$  and  $d_2$ . For extrapolation,  $P_1$  and  $P_2$  and  $d_1$  and  $d_2$  are chosen to be the core database values closest to the desired power  $P$  or distance  $d$ .

The noise level at engine power,  $P_1$ , and distance,  $d$ , is given by:

$$L_{P1,d} = L_{P1,d1} + \frac{(L_{P1,d2} - L_{P1,d1}) \cdot (\log_{10}[d] - \log_{10}[d_1])}{(\log_{10}[d_2] - \log_{10}[d_1])} \quad \text{Eq. 4-9}$$

where

- $P_1, P_2$  Engine power values for which noise data are available in the NPD database (dependent on aircraft);
- $d_1, d_2$  Distance values for which noise data are available in the NPD database (ft);
- $L_{P1,d1}$  Noise level at power  $P_1$  and distance  $d_1$  (dB);
- $L_{P2,d1}$  Noise level at power  $P_2$  and distance  $d_1$  (dB);
- $L_{P1,d2}$  Noise level at power  $P_1$  and distance  $d_2$  (dB); and
- $L_{P2,d2}$  Noise level at power  $P_2$  and distance  $d_2$  (dB).

The noise level at engine power,  $P_2$ , and distance,  $d$ , is given by:

$$L_{P2,d} = L_{P2,d1} + \frac{(L_{P2,d2} - L_{P2,d1}) \cdot (\log_{10}[d] - \log_{10}[d_1])}{(\log_{10}[d_2] - \log_{10}[d_1])} \quad \text{Eq. 4-10}$$

Finally, the interpolated/extrapolated noise level at engine power,  $P$ , and distance,  $d$ , is given by:

$$L_{P,d} = L_{P1,d} + \frac{(L_{P2,d} - L_{P1,d}) \cdot (P - P_1)}{(P_2 - P_1)} \quad \text{Eq. 4-11}$$

The above methodology is utilized when:

1. The engine power and/or distance associated with the receptor/segment pair lies between existing values in the NPD data (i.e., interpolation);
2. The power and/or distance associated with the receptor/segment pair is larger than existing values in the NPD data (i.e., extrapolation); or

<sup>xviii</sup> Several of the military aircraft contain NPD data for afterburner operations (equivalent of "FIXED" interpolation in NOISEMAP). If a particular flight path segment is identified as an afterburner segment, interpolation or extrapolation is only performed with regard to distance, not power.

- The power associated with the receptor/segment pair is smaller than existing values in the NPD data (i.e., extrapolation). When noise levels are extrapolated to power settings below those represented by the NPD curves, the extrapolation is limited to 5 dB below the lowest noise curve. The limit is included to prevent extrapolation to unrealistic noise levels.

The general noise interpolation/extrapolation process described in this section is applicable for the four fundamental noise-level metrics,  $L_{AE}$ ,  $L_{EPN}$ ,  $L_{ASmx}$ , and  $L_{PNTSmx}$ . The specific engine power and distance value used in the interpolation/extrapolation process is different for exposure-based noise-level metrics as compared with maximum noise-level metrics. In addition, another special noise extrapolation process is invoked when the distance associated with the receptor/segment pair is smaller than the smallest distance in the NPD data (i.e., 200 ft). These special cases are discussed separately for exposure-based noise-level metrics and maximum noise-level metrics (see Sections 4.2.2.2 and 4.2.2.3).

#### 4.2.2.2 Additional Interpolation Information for Exposure-Based Noise Level Metrics

For exposure-based metrics, if the end points of a fixed path segment are defined by  $P_1$  at the start of the segment, and  $P_2$  at the end of the segment, then the exposure-based noise level, either  $L_{AE}$  or  $L_{EPN}$  interpolated or extrapolated for a receptor/segment pair, is given by:

$$L_{P,d} = \begin{cases} L_{P_{seg,d}=SLR_{pth}} & \text{Observer behind or ahead of segment} \\ L_{P_{seg,d}=SLR_{seg}} & \text{Observer astride segment} \end{cases} \quad \text{Eq. 4-12}$$

where

$L_{P_{seg,d}=SLR_{pth}}$  Interpolated noise level (dB) based upon engine power associated with the flight path segment,  $P_{seg}$ , as defined in Section 4.1.2, and the distance to the PCPA on the extended flight path segment; and

$L_{P_{seg,d}=SLR_{seg}}$  Interpolated noise level (dB) based upon engine power associated with the flight path segment,  $P_{seg}$ , and the distance to the CPA on the flight path segment where CPA = PCPA.

For the special case in which  $SLR_{pth}$  or  $SLR_{seg}$  is smaller than the smallest distance value in the NPD data, i.e., 200 ft, cylindrical divergence (i.e., line-source) is assumed, and a  $10 \log_{10}[d_1/d_2]$  relationship is used for the  $L_{AE}$ -based and  $L_{EPN}$ -based noise-level metrics. For example, if  $L_{AE}$  at 200 ft and for a given power setting in the NPD data is 95.6 dB, the extrapolated  $L_{AE}$  at 100 ft and at the same power setting is  $95.6 + 10 \log_{10}[200/100] = 98.6$  dB. In addition, AEDT uses a minimum slant distance of 1 ft.

#### 4.2.2.3 Additional Interpolation Information for Maximum Noise Level Metrics

For maximum noise-level metrics, if the end points of a fixed path segment are defined by  $P_1$  at the start of the segment, and  $P_2$  at the end of the segment, then the maximum noise level, either  $L_{ASmx}$  or  $L_{PNTSmx}$ , as appropriate, interpolated/extrapolated for a receptor/segment pair, is given by:

$$L_{P,d} = \begin{cases} \text{Max}[L_{P,d,START}, L_{P,d,END}] & \text{Observer behind or ahead of segment} \\ \text{Max}[L_{P,d,START}, L_{P,d,PCPA}, L_{P,d,END}] & \text{Observer astride segment} \end{cases} \quad \text{Eq. 4-13}$$

where



Max[ ]	Function that returns the maximum of two or three noise level values;
$L_{P,d,START}$	Interpolated noise level (dB) based upon the distance and engine power values associated with the start of the flight path segment;
$L_{P,d,END}$	Interpolated noise level (dB) based upon the distance and engine power values associated with the end of the flight path segment; and
$L_{P,d,PCPA}$	Interpolated noise level (dB) based upon the distance and engine power values associated with PCPA=CPA on the flight path segment.

As with exposure-based metrics, a special case applies for maximum noise level metrics when the distance is smaller the smallest distance value in the NPD data, i.e., 200 ft. For the  $L_{ASmx}$ -based and  $L_{PNTSmx}$ -based noise metrics, spherical divergence (i.e., a point-source) is assumed and a  $20 \log_{10}[d_1/d_2]$  relationship is used. For example, if  $L_{ASmx}$  at 200 ft and for given power setting in the NPD database is 95.6 dB, then the extrapolated  $L_{ASmx}$  at 100 ft at the same power setting is  $95.6 + 20 \log_{10}[200/100] = 101.6$  dB. Similar to NPDs for exposure-based metrics, AEDT uses a minimum slant distance of 1 ft with maximum noise level NPDs.

#### 4.2.2.4 Noise Level Interpolation/Extrapolation for Helicopters

Interpolation or extrapolation of helicopter NPD data is slightly more involved than the standard aircraft NPD interpolation and extrapolation. Besides the three standard dynamic operational modes (approach, departure and overflight), there are also helicopter noise data for four static modes (ground idle, flight idle, hover-in-ground-effect (HIGE), and hover-out-of-ground-effect (HOGE)).

Although interpolation and extrapolation on the Helicopter NPDs for the four static modes are performed in the same manner as standard aircraft interpolation and extrapolation presented in Section 4.2.2, interpolation and extrapolation for the three dynamic modes are handled differently because the data set for each operational mode consists of three NPD curves, adding another dimension to the interpolation and extrapolation. The NPD curves for the dynamic modes also take into account in-flight directivity and are labeled Left, Center and Right. For these dynamic modes, interpolations and extrapolations between distance values are handled according to Section 4.2.2, and interpolations and extrapolations between the Left, Center and Right NPDs are accounted for with the Lateral Directivity Adjustment (see Section 4.5.2). Similar to afterburner NPDs for military aircraft, interpolation or extrapolation is only performed on helicopter NPDs with regard to distance, not power, since helicopter NPDs are organized according to operational mode, not thrust setting.

### 4.3 General AEDT Noise Adjustments

The sound level adjustments presented in Sections 4.3.1 through 4.3.6 are applicable to all aircraft in AEDT. These adjustments include atmospheric absorption ( $AA_{ADJ}$ ), acoustic impedance ( $AI_{ADJ}$ ), noise fraction ( $NF_{ADJ}$ ), duration ( $DUR_{ADJ}$ ), lateral attenuation ( $LA_{ADJ}$ ), and line-of-sight blockage ( $LOS_{ADJ}$ ).

#### 4.3.1 Atmospheric Absorption Adjustment ( $AA_{ADJ}$ )

The spectral data in AEDT has been corrected to reference day conditions, using the SAE-AIR-1845<sup>3</sup> standard atmosphere at a distance of 305 m. SAE-AIR-1845 specifies a hypothetical atmosphere using average atmospheric absorption rates. These average atmospheric absorption rates are also used in the calculation of the AEDT standard NPD data and are therefore already included in the NPDs in the AEDT Fleet database.

Sound propagation is affected by changes in atmospheric conditions. Sound levels tend to be lower in low humidity environments as compared to high humidity environments due to the increased atmospheric absorption associated with the lower humidity. The spectral database in AEDT allows a user to take into account atmospheric absorption due to the effects of local meteorological conditions on an airport-specific basis. AEDT provides two different atmospheric adjustments based on international guidance: either SAE-ARP-866A<sup>2</sup> (which takes into account temperature and relative humidity effects), or SAE-ARP-5534<sup>4</sup> (which takes into account temperature, relative humidity and atmospheric pressure effects).

The following steps, which are consistent with the simplified procedure of 14 CFR Part 36<sup>26</sup>, are used to correct the data to the user-defined atmospheric conditions:

1. The user determines whether to apply the SAE-ARP-866A<sup>2</sup> or SAE-ARP-5534<sup>4</sup> atmospheric absorption adjustment to account for the user-defined atmospheric conditions.
  - a. If airport weather is not available or ISA weather is selected for modeling, AEDT assumes a default temperature of 59°F (at sea level) and 60% relative humidity for the atmospheric absorption adjustment. Note that the 60% relative humidity differs from the 70% relative humidity assumed in 14 CFR Part 36 and SAE-ARP-866A<sup>2</sup> to allow for the emissions and noise calculations in AEDT to use a consistent relative humidity assumption.
2. The aircraft spectrum is A-weighted (or C-weighted, as appropriate) and corrected back to the source, (from the 1,000 ft reference), effectively removing the SAE-AIR-1845<sup>3</sup> atmosphere. This is the weighted source spectrum.
3. The weighted source spectrum is then corrected to the 10 standard AEDT distances assuming two conditions: the AEDT standard atmosphere based on SAE-AIR-1845<sup>3</sup> and a user-supplied atmosphere generated with either SAE-ARP-866A<sup>2</sup> or SAE-ARP-5534<sup>4</sup>. These are spectrum<sub>1845, d</sub> and spectrum<sub>MOD, d</sub>, respectively.
4. The 24 one-third octave band values of each spectrum are logarithmically summed at each AEDT NPD distance, yielding a distance-specific, atmosphere-specific sound pressure level ( $L_{1845, d}$  and  $L_{MOD, d}$ ). These levels are then arithmetically subtracted for each AEDT distance ( $L_{1845, d} - L_{MOD, d}$ ). This distance-specific delta represents the difference between the metric propagated through the SAE-AIR-1845<sup>3</sup> atmosphere and the metric propagated through the user-supplied atmosphere generated with either SAE-ARP-866A<sup>2</sup> or SAE-ARP-5534<sup>4</sup> at each distance.
5. The distance-specific delta is the atmospheric absorption adjustment ( $AA_{Adj}$ ), which takes into account the user-defined temperature and humidity. It is applied to the appropriate NPD values ( $NPD_d + (L_{1845, d} - L_{MOD, d})$ ) at the corresponding AEDT distance.

An example of the atmospheric absorption correction is presented in Section 11.1.4.

The atmospheric absorption correction for the C-weighted family of noise metrics is calculated similar to the process outlined above using C-weighting in place of A-weighting. The atmospheric absorption adjustment for tone-corrected perceived noise metrics is based on A-weighted spectral data. This process is considered to be a reasonable approximation for these metrics.

#### 4.3.2 Acoustic Impedance Adjustment ( $AI_{Adj}$ )

Before the interpolated/extrapolated noise level data,  $L_{p,d}$ , are utilized for computations, an acoustic impedance adjustment, designated by the symbol  $AI_{Adj}$ , is applied. Acoustic impedance is related to the

propagation of sound waves in an acoustic medium, and is defined as the product of the density of air and the speed of sound. It is a function of temperature, atmospheric pressure, and indirectly altitude.

The noise-levels in the AEDT NPD database are corrected to reference-day conditions: temperature 77°F, pressure 29.92 inches of mercury, and 0 ft MSL. The noise levels can be adjusted to airport temperature and pressure by:

$$AI_{ADJ} = 10 \log_{10} \left[ \frac{\rho \cdot c}{409.81} \right] \quad \text{Eq. 4-14}$$

$$\rho \cdot c = 416.86 \cdot \left( \frac{\delta}{\theta^{1/2}} \right) \quad \text{Eq. 4-15}$$

where

- $AI_{ADJ}$  Acoustic impedance adjustment to be added to noise level data in the AEDT NPD database (dB);
- $\rho \cdot c$  Specific acoustic impedance at receptor altitude (MSL) and pressure (N-s/m<sup>3</sup>);
- $\theta$  Ratio of absolute temperature at the receptor to standard-day absolute temperature at sea level; and
- $\delta$  Ratio of atmospheric pressure at the receptor to standard-day pressure at sea level.

When terrain elevation is invoked,  $AI_{ADJ}$  is computed and applied to the NPD data on a receptor-by-receptor basis, according to the receptor altitude, temperature, and pressure. Otherwise, the airport elevation and the receptor altitude are equivalent, and a single value of  $AI_{ADJ}$  is computed and applied, regardless of the observation point.

When terrain elevation is not invoked and when airport temperature, pressure, and altitude are equal to 77°F, 29.92 in-Hg, and 0 ft MSL, respectively, then  $AI_{ADJ}$  is essentially 0.0 dB (-4.0 x 10<sup>-6</sup> dB).

#### 4.3.3 Noise Fraction Adjustment for Exposure Metrics ( $NF_{ADJ}$ )

The exposure-based noise level data interpolated/extrapolated from the AEDT NPD data,  $L_{p,d}$ , represents the noise exposure level associated with a flight path of infinite length. However, the aircraft flight path is described by a set of finite-length segments, each contributing varying amounts of exposure to the overall noise metric computed at a receptor.

The noise fraction algorithm, used exclusively for computation of the exposure-based metrics ( $L_{AE}$ ,  $L_{CE}$ ,  $L_{EPN}$ ), and indirectly for computation of the time-above metrics ( $TA_{LA}$ ,  $TA_{LC}$ ,  $TA_{PNT}$ ), computes the fraction of noise exposure associated with a finite-length flight path segment. This fraction of noise exposure is computed relative to the noise associated with a flight path of infinite length. It is based upon a fourth-power, 90-degree dipole model of sound radiation.

Computation of the noise fraction is necessary because the  $L_{AE}$ ,  $L_{CE}$ , and  $L_{EPN}$ -based noise levels in the NPD database are computed assuming that an aircraft proceeds along a straight flight path, parallel to the ground, and of infinite length. To obtain the noise exposure level or time-above at a receptor location due to an aircraft proceeding along a finite fixed path segment, the exposure-based noise-level data, interpolated/extrapolated from the AEDT NPD data, must be adjusted by a fractional component, which is associated with the geometry of the receptor/flight-segment pair.

#### 4.3.3.1 Noise Fraction Adjustment for Flight Path Segments

For an arbitrary segment, the fourth-power time-history model computes noise exposure fraction,  $F_{12}$ , as follows:

$$F_{12} = \left( \frac{1}{\pi} \right) \cdot \left[ \frac{\alpha_2}{(1 + \alpha_2^2)} + \tan^{-1}(\alpha_2) - \frac{\alpha_1}{(1 + \alpha_1^2)} - \tan^{-1}(\alpha_1) \right] \quad \text{Eq. 4-16}$$

where

$$\alpha_1 = \frac{-q_1}{S_L} \quad \text{Eq. 4-17}$$

$$\alpha_2 = \frac{(-q_1 + L)}{S_L} \quad \text{Eq. 4-18}$$

$$S_L = S_0 \cdot 10^{\frac{[L_{E,P,d} - L_{Smz,p,d}]}{10}} \quad \text{Eq. 4-19}$$

where

$q_1$	Relative distance (ft) from the segment start point to point P <sub>s</sub> ;
$L$	Length of segment (ft);
$S_0$	171.92 ft for $L_{AE}$ and $L_{CE}$ , or 1719.2 ft for $L_{EPN}$ ;
$L_{E,P,d}$	Unadjusted interpolated NPD noise exposure level (dB) at 160 kts ( $L_{AE}$ , $L_{CE}$ , $L_{EPN}$ ); and
$L_{Smx,P,d}$	Unadjusted interpolated NPD maximum noise level (dB) ( $L_{ASmx}$ , $L_{CSmx}$ , $L_{PNTSmx}$ ).

Both  $L_{E,P,d}$  and  $L_{Smx,P,d}$  are interpolated from NPD data at a given engine power setting and at a distance  $SLR_{pth}$ , which is the distance from the receptor to the PCPA on the extended segment.

The noise fraction is then converted to a dB adjustment:

$$NF_{ADJ} = 10 \log_{10}[F_{12}] \quad \text{Eq. 4-20}$$

The noise fraction term in AEDT has a lower limit set to -150 dB. This corresponds to a minimum value of  $10^{-15}$  for the energy fraction  $F$ , below which there would be a risk to produce an undetermined Logarithm (e.g.,  $F \leq 0$ ).

#### 4.3.3.2 Noise Fraction Adjustment for Behind Start-of-Takeoff Roll

For a receptor behind the start-of-takeoff ground roll, a special case of the noise fraction equation applies. This special case noise fraction, denoted by the symbol  $F_{12}'$ , ensures consistency of computed exposure levels that are on a line at azimuth angle of 90 degrees measured from the nose of the aircraft at start of takeoff roll.

$$F_{12}' = \left( \frac{1}{\pi} \right) \cdot \left[ \frac{\alpha_2}{(1 + \alpha_2^2)} + \tan^{-1}(\alpha_2) \right] \quad \text{Eq. 4-21}$$

$$\alpha_2 = \left( \frac{L}{S_L} \right) \quad \text{Eq. 4-22}$$

where  $L$  and  $S_L$  are defined in Section 4.3.3.1. This adjustment is supplemented by the ground based directivity adjustment  $DIR_{ADJ}$  (see Section 4.4.2).

The noise fraction for the special case of receptors behind the start-of-takeoff roll is then converted to a dB adjustment:

$$NF_{ADJ} = 10 \log_{10} [F_{12}' ] \quad \text{Eq. 4-23}$$

A similar equation is used for receptors in front of the end point of the last approach segment.

$$F_{12}' = \left( \frac{1}{\pi} \right) \cdot \left[ -\frac{\alpha_1}{(1 + \alpha_1^2)} - \tan^{-1}(\alpha_1) \right] \quad \text{Eq. 4-24}$$

$$\alpha_1 = \left( \frac{-L}{S_L} \right) \quad \text{Eq. 4-25}$$

#### 4.3.4 Duration Adjustment for Exposure-Based Metrics ( $DUR_{ADJ}$ )

For exposure-based metrics, consistent with SAE-AIR-1845<sup>3</sup>, NPDs are derived for a reference speed of 160 kts for fixed-wing aircraft. For fixed-wing aircraft speeds other than 160 kts, the duration adjustment is applied to account for the effect of time-varying aircraft speed, acceleration, and deceleration. It is not applied to maximum noise level metrics since they are mostly independent of speed. In addition, since runup operations are static operations without associated speeds, the duration adjustment is not applied.

For fixed-wing aircraft, the  $L_{AE}$  and  $L_{EPN}$  values in the NPD database are referenced to an aircraft speed of 160 kts. For other aircraft speeds, the aircraft speed adjustment in dB,  $DUR_{ADJ}$ , is given by:

$$DUR_{ADJ} = 10 \log_{10} \left[ \frac{AS_{ref}}{AS_{seg}} \right] \quad \text{Eq. 4-26}$$

where

- $AS_{ref}$  Reference aircraft speed (160 kts for fixed-wing aircraft); and
- $AS_{seg}$  Aircraft speed at the closest point for approach (CPA) for the segment).

Helicopters in the AEDT database are referenced to NPD-specific reference speeds based on measurement-specific information when the data were collected. These helicopter-specific reference speeds are applied as  $AS_{ref}$  in Eq. 4-26, when calculating the aircraft speed adjustment,  $DUR_{ADJ}$ , for helicopters.

### 4.3.5 Lateral Attenuation Adjustment (LA<sub>ADJ</sub>)

The difference in level between the sound directly under the aircraft's flight path and at a location to the side of the aircraft at the time of closest approach is termed lateral attenuation. The lateral attenuation adjustment takes into account the following effects on aircraft sound due to over-ground propagation<sup>xix</sup>:

- Ground reflection effects,
- Refraction effects,
- Airplane shielding and engine installation effects.

For the lateral attenuation adjustment in AEDT, the ground beneath the receptor is defined by a flat plane, regardless of whether the terrain feature is invoked or not. The absorption of reflected noise as it propagates over this flat plane (or any surface) is known as ground effect. The ground effect component of the lateral attenuation adjustment assumes propagation over soft ground, which is considered acoustically absorptive. This effect is defined by equation Eq. 4-34. In AEDT, the ground effect component of the lateral attenuation adjustment for helicopter and propeller aircraft (e.g., tour aircraft) can be turned off in order to model propagation over hard ground types. Since hard ground effects are most prominent close to the ground, jets are always modeled over soft ground in AEDT.

The specific algorithms used for computing lateral attenuation in AEDT are dependent on aircraft type, civil or military. Section 4.3.5.1 describes the lateral attenuation algorithms for civil aircraft, and Section 4.3.5.2 describes the lateral attenuation algorithms for military aircraft.

It is important to note that if terrain effects are included in an AEDT study, either the lateral attenuation adjustment or the line-of-sight blockage adjustment are implemented in the noise adjustment computation, but not both. Instead, the lateral attenuation adjustment is compared to the line-of-sight blockage adjustment on a segment-receiver calculation-by-calculation basis, and the larger of the two values is applied to the calculations. A detailed description of this computation is included in Section 4.3.6.

#### 4.3.5.1 Lateral Attenuation Adjustment for Civil Aircraft

The lateral attenuation adjustment for civil aircraft is based on SAE-AIR-5662<sup>27</sup>. SAE-AIR-5662 provides methods for combining multiple lateral attenuation effects, including those related to source configuration (recognizing different source effects among jet aircraft with fuselage-mounted engines and wing-mounted engines, as well as propeller-driven aircraft), and those related to propagation.

Computation of the lateral attenuation adjustment for aircraft in AEDT depends upon the following parameters:

1. The sideline distance from the flight path segment to the receptor,  $l_{seg}^{xx}$ ;

---

<sup>xix</sup> The lateral attenuation adjustment in AEDT was derived from field measurements made over grass-covered, acoustically soft terrain. Consequently, when source-to-receiver propagation occurs primarily over an acoustically hard surface (e.g., water), and the hard surface dominates the study environment, it is possible that AEDT could under predict the actual noise level.

<sup>xx</sup> It is important to note that the lateral attenuation adjustment uses the sideline distance to the closest point of approach (CPA) on the segment as  $l_{seg}$  in the noise computation, and not the distance to the perpendicular closest point of approach (PCPA). In addition, AEDT can accept a lateral distance of  $l_{seg}$  equal zero, even

- 
2. The elevation angle,  $\beta$ , formed by  $SLR_{seg}$  and the horizontal plane of the receptor location, given by the following equation:

$$\beta = \sin^{-1} \left( \frac{d_{seg}}{SLR_{seg}} \right) \quad \text{Eq. 4-27}$$

where

$d_{seg}$  Refer to Eq. 4-2 and

$$SLR_{seg} = (d_{seg}^2 + l_{seg}^2)^{1/2} \quad \text{Eq. 4-28}$$

3. The aircraft bank angle,  $\varepsilon$ ; and  
4. The depression angle,  $\varphi$ , which is defined by  $\beta$  and  $\varepsilon$  in the following equation:

$$\varphi = \varepsilon + \beta \quad \text{Eq. 4-29}$$

These parameters are presented in Figure 4-4 and Figure 4-5.

---

though AEDT uses a minimum slant distance of 1 ft in most other portions of the noise computation process. When  $l_{seg}$  equals zero, the aircraft is directly above the receptor location.

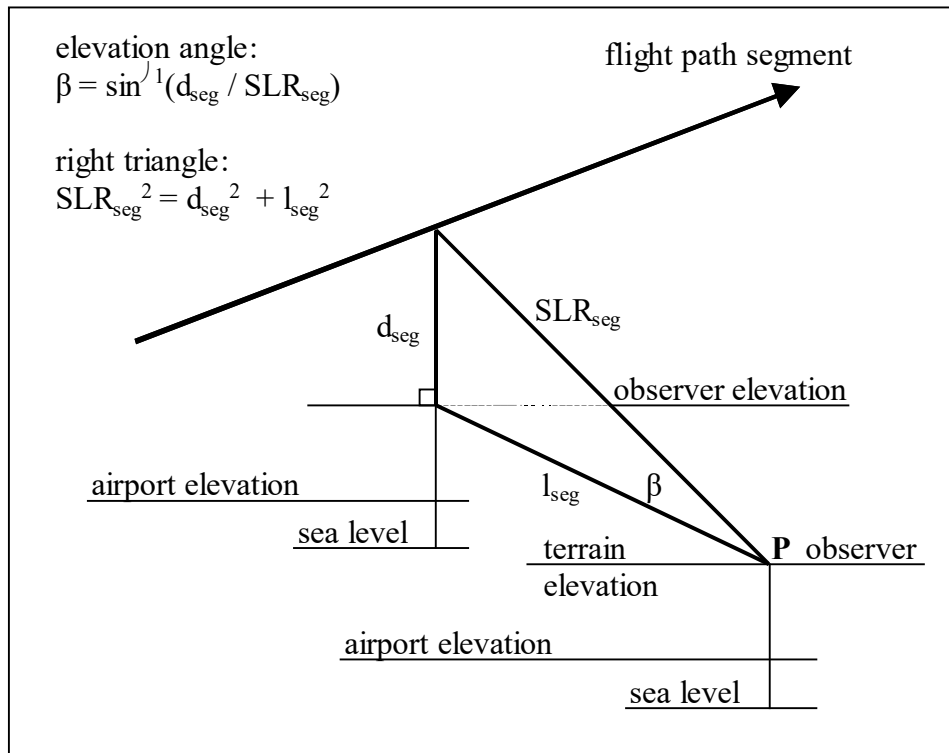

Figure 4-4 Lateral Attenuation Geometry

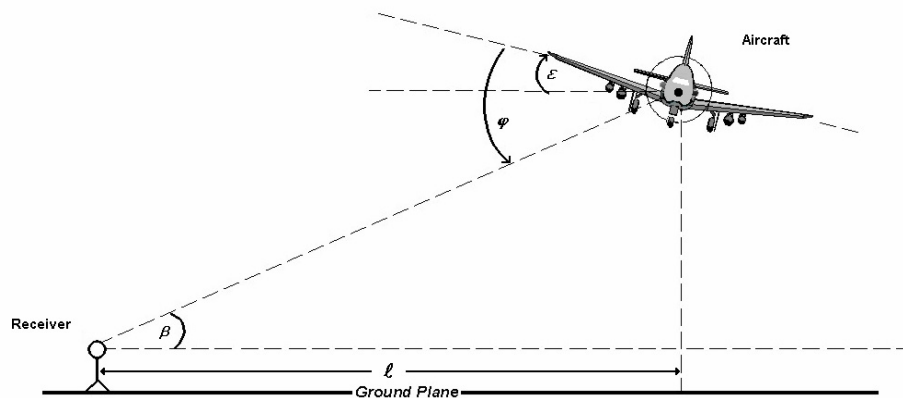

Figure 4-5 Bank Angle  $\epsilon$ , Elevation Angle  $\beta$ , Depression Angle  $\phi$ , and Lateral Distance  $l$ <sup>27</sup>

The four parameters are applied to the following equations for calculating lateral attenuation for civil aircraft that take into account engine-installation effects,  $E_{ENGINE}(\phi)$ , attenuation due to ground effects,  $G(l_{seg})$ , and attenuation due to refraction-scattering effects,  $\Lambda(\beta)$ . These effects are calculated differently for each aircraft engine-installation (wing-mounted, fuselage-mounted or propeller-driven engines) and for each of the following different sets of aircraft position criteria relative to the receiver:

1. Aircraft is on the ground or the elevation angle associated with the aircraft/receiver pair is less than 0 degrees;



2. Aircraft is airborne, the elevation angle is greater than 0 degrees, and the lateral (or sideline) distance is greater than 3,000 ft (914 m); or
3. Aircraft airborne, the elevation angle is greater than 0 degrees, and the lateral distance is less than or equal to 3,000 ft (914 m).

The engine-installation effect component of the lateral attenuation adjustment,  $E_{ENGINE}(\varphi)$ , accounts for any lateral directional effects due to noise shielding attributed to the location of the engines on the aircraft wing or fuselage. The engine-installation effect component is computed with the following equations, which are dependent on engine mounting location (fuselage or wing) and depression angle.

The engine installation effect (in dB) for an airplane with fuselage-mounted jet engines is:

$$E_{FUS}(\varphi) = 10 \log_{10}([0.1225 \cdot \cos^2(\varphi) + \sin^2(\varphi)]^{0.329}) \quad -180^\circ \leq \varphi \leq 180^\circ \quad \text{Eq. 4-30}$$

where

$\varphi$       Depression angle (degrees).

The engine installation effect (dB) for an airplane with wing-mounted jets engines is:

$$E_{WING}(\varphi) = \begin{cases} 10 \log_{10} \left( \frac{[(0.0039 \cdot \cos^2(\varphi) + \sin^2(\varphi)]^{0.062}}{[0.8786 \cdot \sin^2(2\varphi) + \cos^2(2\varphi)]} \right) & 0^\circ \leq \varphi \leq 180^\circ \\ -1.49 & 0^\circ > \varphi > -180^\circ \end{cases} \quad \text{Eq. 4-31}$$

The engine installation effect (dB) for an airplane with propeller-driven engines is:

$$E_{PROP}(\varphi) = 0.00 \quad \text{Eq. 4-32}$$

Since helicopter directional effects are represented by the left-center-right NPD curves and the directivity adjustments (see Section 4.4.2) their engine installation effects are already taken into account and therefore are represented by:

$$E_{HELI}(\varphi) = E_{PROP}(\varphi) = 0.00 \quad \text{Eq. 4-33}$$

The engine installation effects for jet-powered airplanes are illustrated in Figure 4-6.

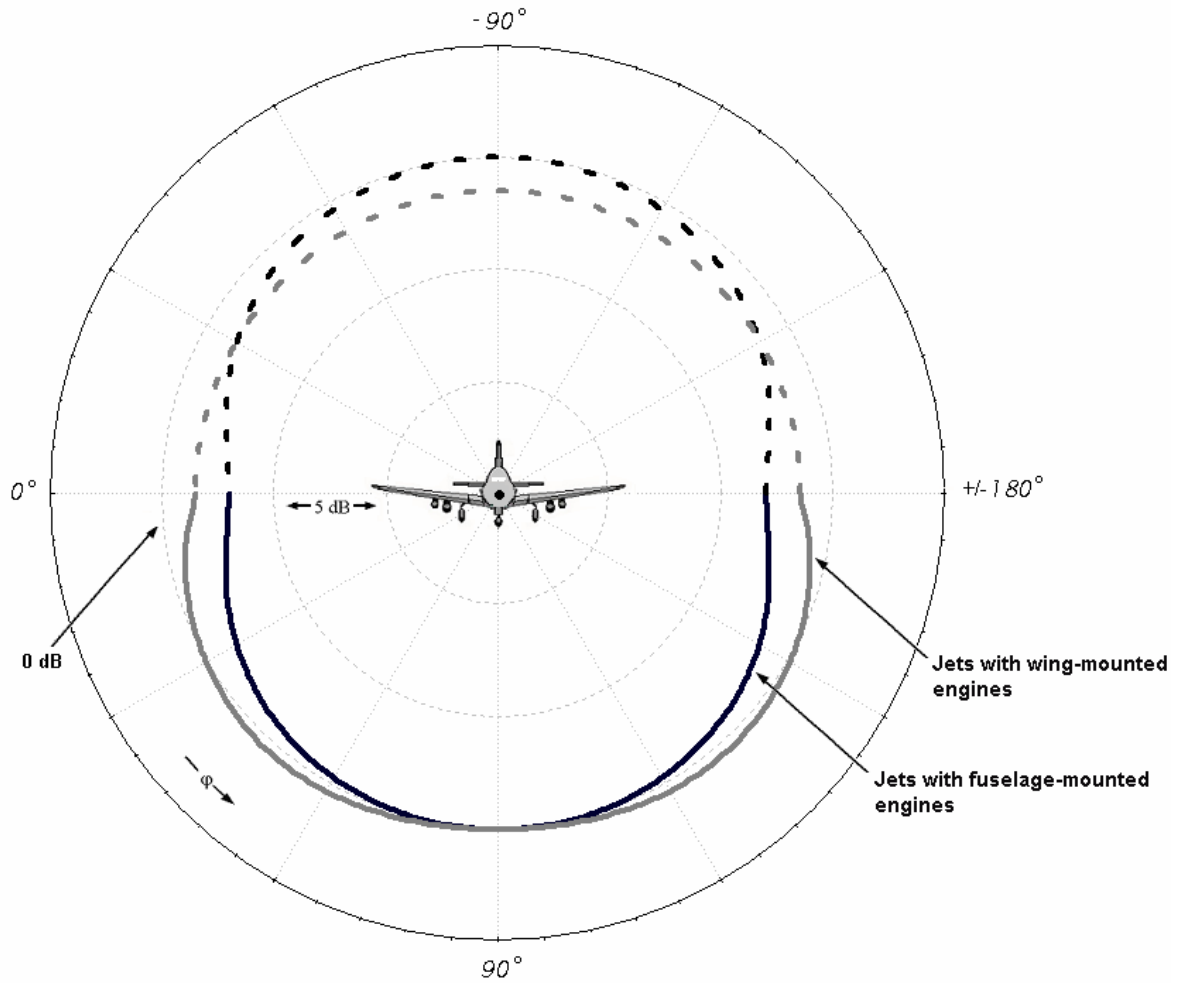

Figure 4-6 Illustration of Engine-Installation Effects for Jet-Powered Airplanes<sup>27</sup>

The ground effect, or ground-to-ground, component of the lateral attenuation adjustment,  $G(l_{seg})$ , accounts for sound attenuation due to propagation over ground surfaces that may be considered to be “acoustically soft”, such as lawn or field grass. The ground-to-ground component is computed as follows:

$$G(l_{seg}) = \begin{cases} 11.83 \cdot [1 - e^{-0.00274 \cdot l_{seg}}] & 0 \leq l_{seg} \leq 914 \text{ m (3,000 ft)} \\ 10.86 & l_{seg} > 914 \text{ m (3,000 ft)} \end{cases} \quad \text{Eq. 4-34}$$

where

$l_{seg}$  Sideline distance (m) in the horizontal plane from the receptor to the projection of the CPA.

The ground-to-ground component of the lateral attenuation adjustment is illustrated in Figure 4-7.

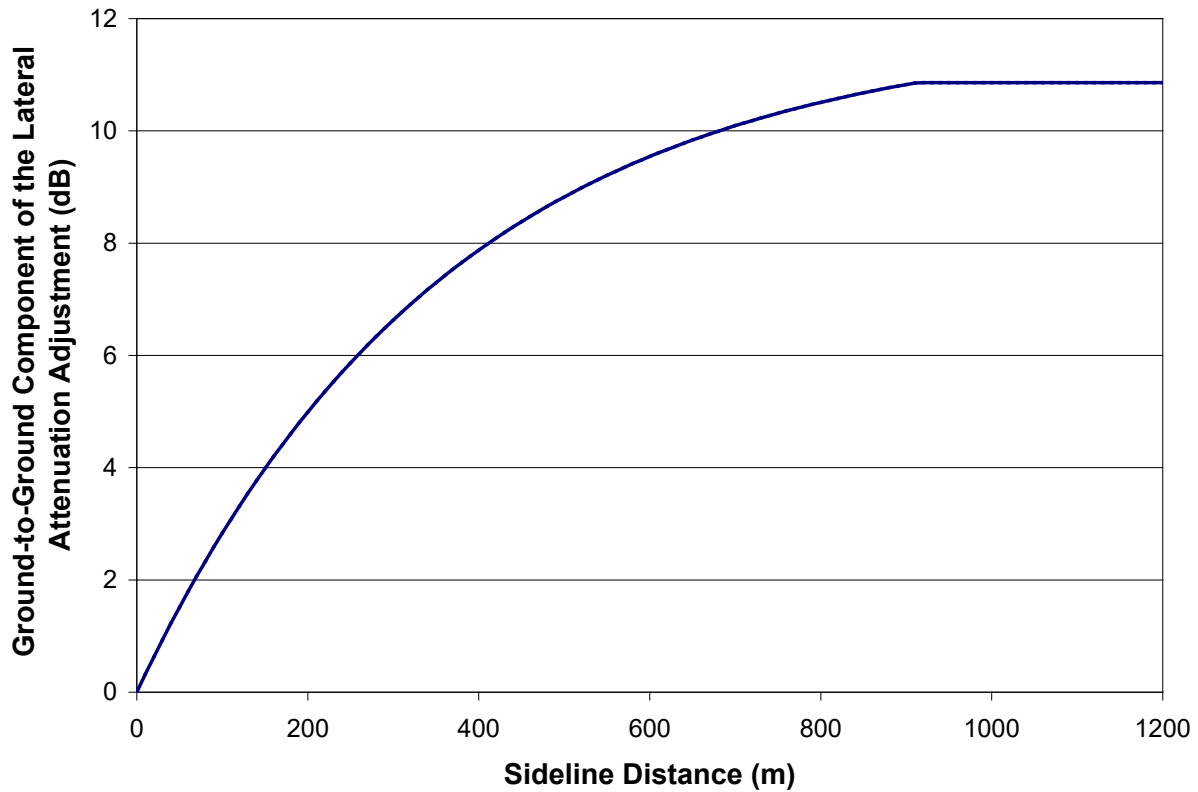

Figure 4-7 Illustration of Ground-to-Ground Component of Lateral Attenuation

The refraction-scattering, or air-to-ground, component of the lateral attenuation adjustment,  $\Lambda(\beta)$ , accounts for additional attenuation due to refraction and scattering of sound, as the result of wind and meteorological conditions. The air-to-ground component is computed as follows:

$$\Lambda(\beta) = \begin{cases} 10.86 & \beta \leq 0^\circ \\ 1.137 - (.229 \times 10^{-1})\beta + 9.72 \cdot e^{-0.142\beta} & 0^\circ < \beta \leq 50^\circ \\ 0.0 & 50^\circ < \beta \leq 90^\circ \end{cases} \quad \text{Eq. 4-35}$$

where

$\beta$  Elevation angle (degrees); if  $\beta \leq 0^\circ$  or the aircraft is on the ground,  $\beta$  is set to  $0^\circ$ .

The air-to-ground component of the lateral attenuation adjustment is illustrated in Figure 4-8.

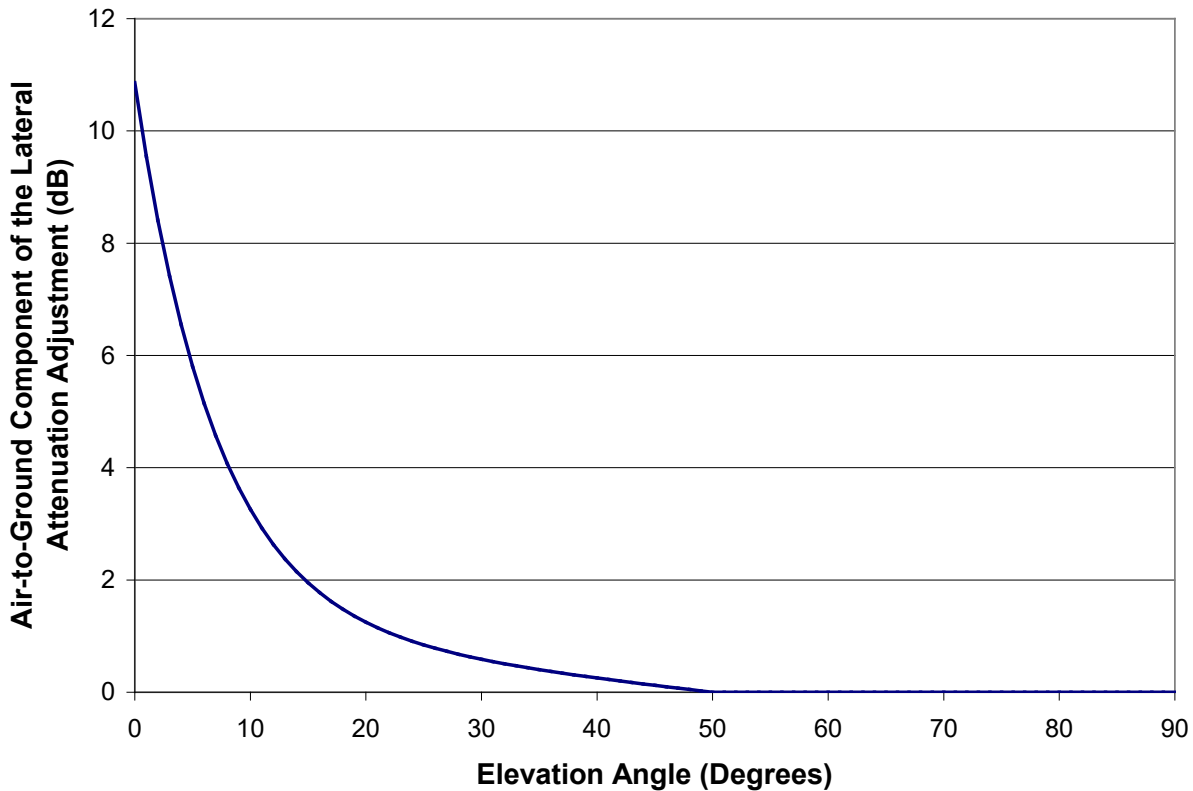

Figure 4-8 Illustration of Air-to-Ground Component of Lateral Attenuation

The overall lateral attenuation adjustment,  $LA_{ADJ}$  (in dB)<sup>xxi</sup>, which takes into account the engine-installation effect component,  $E_{ENGINE}(\varphi)$ , the ground-to-ground component,  $G(l_{seg})$ , and the air-to-ground component,  $\Lambda(\beta)$ , is then computed as follows:

$$LA_{ADJ(AEDT)} = - \left[ E_{ENGINE}(\varphi) - \frac{G(l_{seg}) \cdot \Lambda(\beta)}{10.86} \right] \quad \text{Eq. 4-36}$$

It is important to note that the depression angle in Figure 4-8 is general enough to include the bank angle, therefore the bank angle effect on lateral attenuation is already considered. If bank angle is not zero, the lateral attenuation will be non-symmetric from one side of the aircraft to another.

#### 4.3.5.2 Lateral Attenuation Adjustment for Military Aircraft

The AEDT Fleet database includes all of the aircraft from the United States Air Force NOISEMAP suite of programs<sup>28</sup> as of March 2001. For military aircraft, computation of the lateral attenuation adjustment depends upon the elevation angle,  $\beta$ . If the elevation angle is less than 2 degrees, the adjustment has a

<sup>xxi</sup> For AEDT aircraft, the sign of  $LA_{ADJ(AEDT)}$  is made negative (see Eq. 4-36) in order to fit AEDT calculation conventions.

ground-to-ground component only. If the elevation angle is greater than or equal to 2 degrees, it has both a ground-to-ground and an air-to-ground component. In the latter case, the two components are computed separately and then combined.

The ground-to-ground component of the lateral attenuation adjustment (in decibels) is computed for military aircraft as follows<sup>xxii</sup>:

$$G(l_{seg}) = \begin{cases} 15.09 \cdot [1 - e^{(-.274 \times 10^{-2}) \cdot l_{seg}}] & 0 \leq l_{seg} \leq 401 \text{ m (1316 ft)} \\ 10.06 & l_{seg} > 401 \text{ m (1316 ft)} \end{cases} \quad \text{Eq. 4-37}$$

where

$l_{seg}$  Sideline distance (m) in the horizontal plane from the receptor to the projection of CPA.

The ground-to-ground component of the lateral attenuation adjustment for military aircraft is illustrated in Figure 4-9.

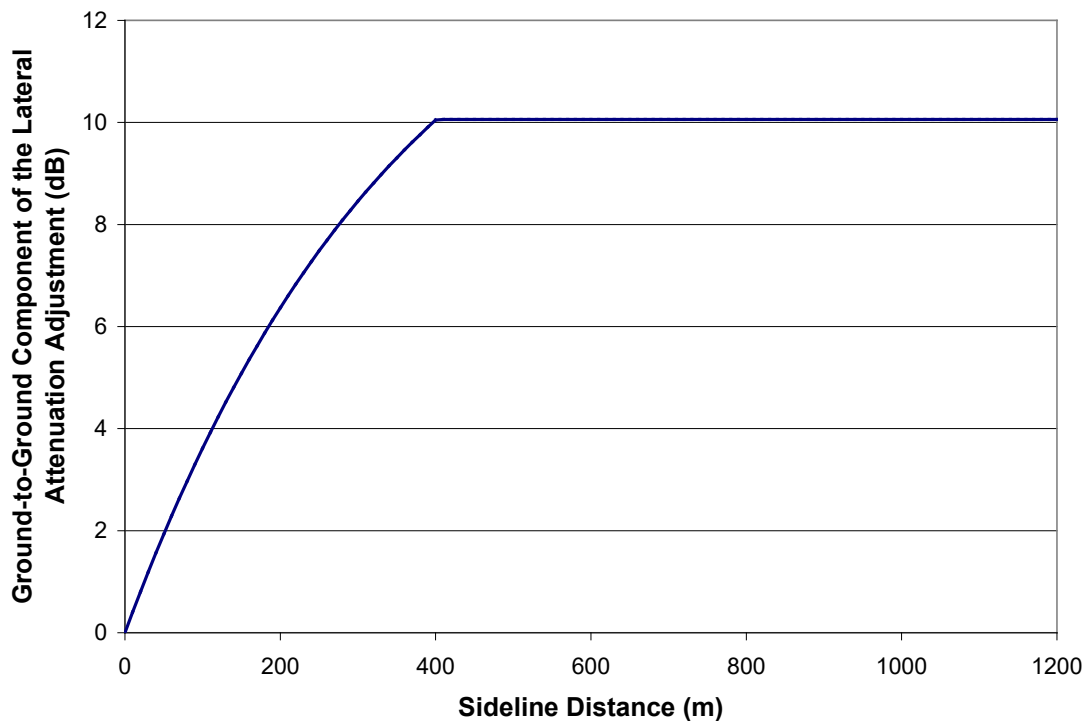

Figure 4-9 Illustration of Ground-to-Ground Component of Lateral Attenuation for Military Aircraft

<sup>xxii</sup> The ground-to-ground component of the lateral attenuation adjustment actually computed by the NOISEMAP program depends on the one-third octave-band frequency characteristics of the noise source. Due to this fact, small differences are expected when comparing AEDT and NOISEMAP results directly, especially in the immediate vicinity of the airport runways.

The air-to-ground component of the lateral attenuation adjustment (in decibels) is computed for military aircraft as follows:

$$\Lambda(\beta) = \begin{cases} \left(\frac{21.056}{\beta}\right) - 0.468 & 2^\circ \leq \beta \leq 45^\circ \\ 0 & 45^\circ \leq \beta \leq 90^\circ \end{cases} \quad \text{Eq. 4-38}$$

where

$\beta$  Elevation angle (degrees); if  $\beta > 0^\circ$ ,  $\beta$  is set to  $0^\circ$ .

The air-to-ground component of the lateral attenuation adjustment for military aircraft is illustrated in Figure 4-10.

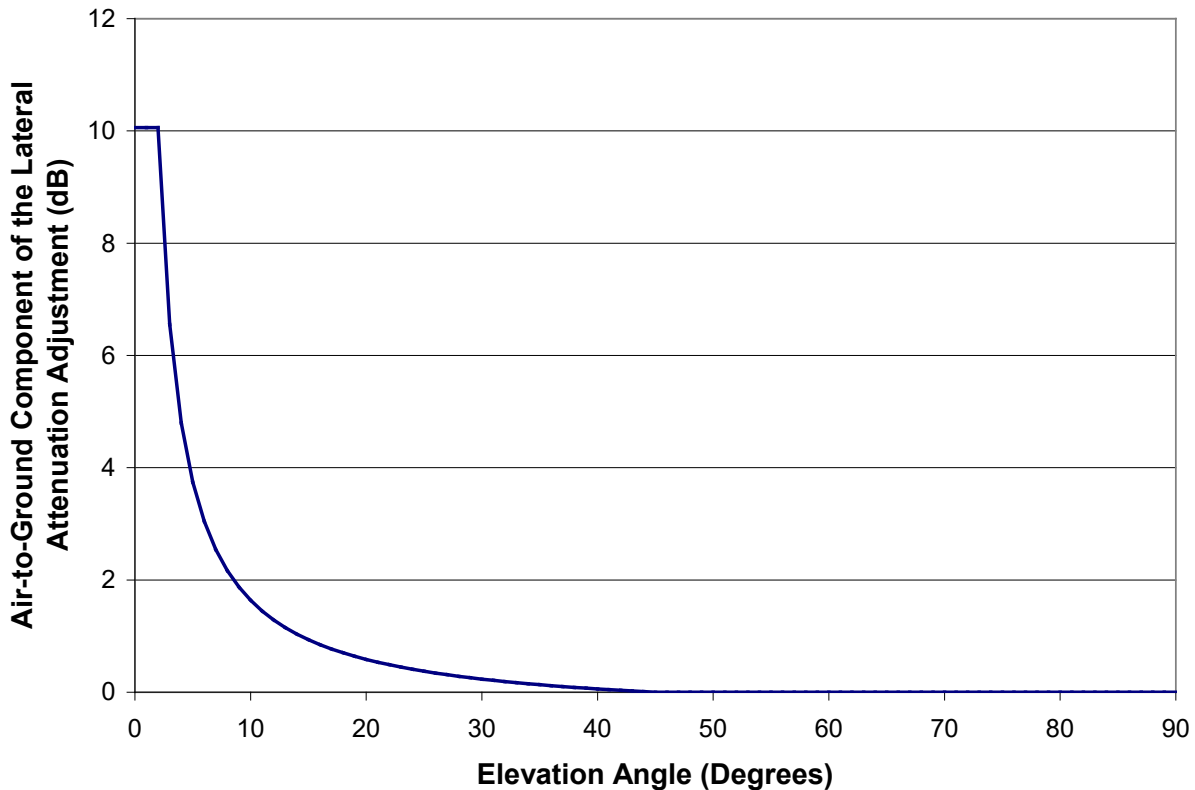

Figure 4-10 Illustration of Air-to-Ground Component of Lateral Attenuation for Military Aircraft

The overall lateral attenuation adjustment,  $LA_{ADJ}$  (in dB), which takes into account both the ground-to-ground component,  $G(l_{seg})$ , and the air-to-ground component,  $\Lambda(\beta)$ , for  $2^\circ \leq \beta$ , is then computed for military aircraft as follows:

$$LA_{ADJ(Military)} = \frac{G(l_{seg}) \cdot \Lambda(\beta)}{10.06} \quad \text{Eq. 4-39}$$

### 4.3.6 Line-of-Sight Blockage Adjustment (LOS<sub>ADJ</sub>)

This adjustment accounts for the attenuation due to line-of-sight (LOS) blockage from terrain features. The LOS blockage calculation is based on the difference in propagation path length between the direct path and propagation over the top of terrain features. This adjustment is compliant with the method described in SAE-AIR-6501<sup>29</sup> "Method for Modeling Line-of-Sight Blockage of Aircraft Noise". The path length difference is used to compute the Fresnel Number ( $N_0$ ), which is a dimensionless value used in predicting the attenuation provided by a noise barrier positioned between a source and a receiver. Figure 4-11 illustrates LOS blockage from a terrain feature.

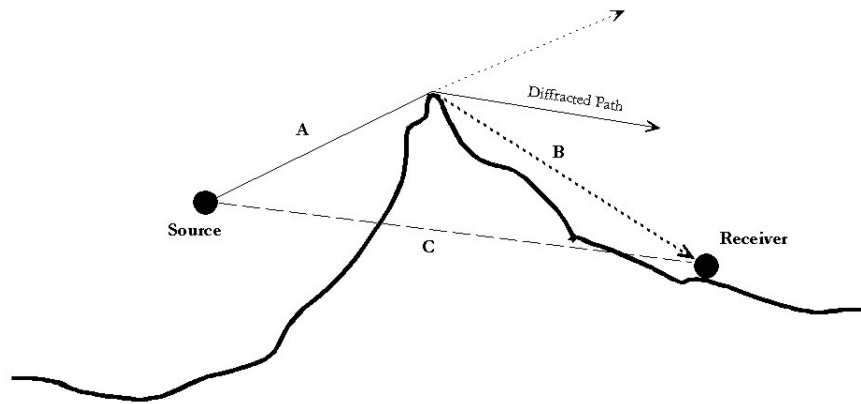

Figure 4-11 Line-of-Sight (LOS) Blockage Concept

The path length difference must be computed first using the following equation:

$$\delta_0 = (A + B) - C \quad \text{Eq. 4-40}$$

where

- A Distance between the source and the top of the barrier;
- B Distance between the top of the barrier and the receiver; and
- C Distance between the source and the receiver.

The LOS<sub>ADJ</sub> is based on the theoretical, frequency-dependent barrier effect (assuming a barrier of infinite length), which is calculated with the following equation:

$$BE_i = \begin{cases} 5 + 20 \log_{10} \left( \frac{\sqrt{2\pi|N_{0,i}|}}{\tan \left( \sqrt{2\pi|N_{0,i}|} \right)} \right) & N_{0,i} < 0 \\ 5 + 20 \log_{10} \left( \frac{\sqrt{2\pi|N_{0,i}|}}{\tanh \left( \sqrt{2\pi|N_{0,i}|} \right)} \right) & N_{0,i} \geq 0 \end{cases} \quad \text{Eq. 4-41}$$

where

$BE_i$  Barrier effect for the i-th one-third octave band; and  
 $N_{0,i}$  Fresnel Number determined along the path defined by a particular source-barrier-receiver geometry for the i-th one-third octave band; computed as follows:

$$N_{0,i} = \pm 2 \left( \frac{\delta_0}{\lambda_i} \right) = \pm 2 \left( \frac{f_i \delta_0}{c} \right) \quad \text{Eq. 4-42}$$

where

$\pm$  Positive in the case where the line of sight between the source and receiver is lower than the diffraction point and negative when the line of sight is higher than the diffraction point;  
 $\delta_0$  Path length difference determined along the path defined by a particular source-barrier-receiver geometry, and  $=(A+B)-C$  (see Figure 4-11);  
 $\lambda_i$  Wavelength of the sound radiated by the source (i-th one-third octave band);  
 $f_i$  Frequency of the sound radiated by the source (i-th one-third octave band); and  
 $c$  Speed of sound.

In AEDT  $N_0$  is limited to -0.1916 at the lower bound, and values of  $N_0$  greater than 10 are set to 23.1<sup>30</sup>.

Since  $LOS_{ADJ}$  is frequency dependent, the following adjustments are made to spectral classes in order to appropriately calculate  $LOS_{ADJ}$ :

1. The aircraft spectral class,  $SC$ , is corrected back to the source (from the 1,000 ft reference), effectively removing the SAE-AIR-1845<sup>3</sup> reference atmosphere, using the following equation:

$$SC_{source,i} = SC_i - \left( (ac_{ref,i}) \cdot \left[ -\frac{1,000ft}{d_{ref}} \right] \right) \quad \text{Eq. 4-43}$$

where

$ac_{ref,i}$  Atmospheric absorption coefficient for the i-th third octave band for the reference atmosphere as presented in SAE-AIR-1845<sup>3</sup>;  
 $SC_i$  i-th octave band of the spectral class;  
 $SC_{source,i}$  i-th octave band of the spectral class corrected back to the source; and  
 $d_{ref}$  1,000 ft in AEDT.

2. The source spectrum is then corrected to the receptor distance in the study atmosphere generated with either SAE-ARP-866A<sup>2</sup> or SAE-ARP-5534<sup>4</sup>, using the following equation:

$$SC_{LOS,i} = SC_{source,i} - \left( (ac_{study,i}) \cdot \frac{SLR_{seg}}{d_{ref}} \right) \quad \text{Eq. 4-44}$$

where

$ac_{study,i}$  Atmospheric absorption coefficient for the i-th third octave band for the study-specific atmosphere as presented in SAE-ARP-866A<sup>2</sup> or SAE-ARP-5534<sup>4</sup>;  
 $SC_{LOS,i}$  i-th octave band of the spectral class corrected back to the receptor;



$SLR_{seg}$  The slant range from the receptor to the point of closest approach on the segment (ft);  
and  
 $d_{ref}$  1,000 ft in AEDT.

- For each one-third octave band, the barrier effect is subtracted (in dB),  $BE_i$ , see Eq. 4-41, from  $SC_{LOS}$ , see Eq. 4-44. The result is referred to as  $SC_{HPP,i}$ .

$$SC_{HPP,i} = SC_{LOS,i} - BE_i \quad \text{Eq. 4-45}$$

- The energy is summed over  $SC_{HPP,i}$  and converted to dB by the following equation:

$$HPP_{total} = 10 \log_{10} \left( \sum_{i=11}^{40} 10^{\frac{SC_{HPP,i}}{10}} \right) \quad \text{Eq. 4-46}$$

- The energy is summed over  $SC_{LOS}$  and converted to dB by the following equation:

$$LOS_{total} = 10 \log_{10} \left( \sum_{i=11}^{40} 10^{\frac{SC_{LOS,i}}{10}} \right) \quad \text{Eq. 4-47}$$

- Finally,  $LOS_{ADJ}$  can be computed using the following equation:

$$LOS_{ADJ} = HPP_{total} - LOS_{total} \quad \text{Eq. 4-48}$$

If line-of-sight blockage is selected for the noise calculations,  $LOS_{ADJ}$  is compared to  $LA_{ADJ}$  on a point-by-point basis and the larger of the two values is applied to the calculations. For each segment-based noise calculation, either  $LOS_{ADJ}$  or  $AI_{ADJ}$  are implemented, but not both. This allows for a seamless transition between  $LOS_{ADJ}$  and  $LA_{ADJ}$ , although it does not handle their interaction. As stated in the Federal Interagency Committee on Aviation Noise (FICAN) report "Assessment of Tools for Modeling Aircraft Noise in the National Parks"<sup>31</sup>, this approach has been validated for distances up to 1,000 feet, beyond which a practical limit between 18 and 25 dB of attenuation can be expected due to refraction and scattering effects<sup>32</sup>. Therefore, an 18 dB attenuation cap is implemented for  $LOS_{ADJ}$  in AEDT, as a practical upper limit on barrier attenuation.

## 4.4 Fixed-Wing Aircraft Adjustments

The sound level adjustments presented in this section are applicable only to fixed-wing aircraft, and not helicopters. These adjustments include thrust reverser ( $TR_{ADJ}$ ) and ground-based directivity ( $DIR_{ADJ}$ ).

### 4.4.1 Thrust Reverser Adjustment ( $TR_{ADJ}$ )

For the special case of computing noise during thrust reverser deployment as part of the landing ground roll, an empirically-derived thrust reverser adjustment is employed. The thrust reverser noise assumptions represent reverse thrust levels in typical aircraft operations, while maintaining agreement between measured and modeled noise generated during landing ground roll. This methodology is based on ICAO Doc 9911<sup>67</sup> and "Thrust Reverser Analysis for Implementation in the Aviation Environmental Design Tool (AEDT)"<sup>33</sup>, which is based on the ICAO Doc 9911 approach in conjunction with supplemental analysis of empirical thrust reverser deployment data for a variety of aircraft. These analyses were

coordinated directly with the lead author of ICAO Doc 9911 and are being considered for possible future enhancement of that document.

In the legacy noise tool (INM versions prior to version 7.0), thrust reverser was applied to all STANDARD approach profiles as 60% of the max rated thrust for jets and 40% for props over a distance of 90% of the total roll-out distance after touchdown. In addition, thrust reverser thrust levels referenced Departure NPDs, instead of Approach NPDs. These thrust values during landing ground roll were used to ensure good agreement between measured and modeled noise levels, but are not necessarily representative of actual thrust levels during thrust reverser deployment. Since the aircraft performance model is common to noise and emissions computations in AEDT, the high thrust assumption is inappropriate when computing fuel burn and emissions. To appropriately model fuel burn and emissions, AEDT models peak thrust reverser engine power levels at 10% of max rated thrust for wide-body aircraft, and 40% of max rated thrust for narrow-body aircraft, decreasing linearly to 10% of max rated thrust over a distance of 90% of the total roll-out distance after touchdown, all of which reference Approach NPDs<sup>xxiii</sup>. In order to account for a higher noise level due to thrust reverser deployment than those due to a typical approach operation at a given thrust level, a thrust reverser adjustment is applied as an NPD dB adjustment that varies according to distance traveled from touchdown on the landing ground roll.

The thrust reverser adjustment for a given segment is calculated with the following equation:

$$TR_{ADJ} = \begin{cases} L_{unadj_{seg}} - L_{narrow_{seg}} & \text{narrowbody aircraft} \\ L_{unadj_{seg}} - L_{wide_{seg}} & \text{widebody aircraft} \\ 0 & \text{propeller and military aircraft} \end{cases} \quad \text{Eq. 4-49}$$

where

- $L_{unadj_{seg}}$  Noise level at  $P_{unadj_{seg}}$  based on Departure NPDs when  $P_{unadj_{seg}} \geq P_{final}$ ;  
noise level at  $P_{unadj_{seg}}$  based on Approach NPDs when  $P_{unadj_{seg}} < P_{final}$ ;
- $P_{final}$  The last power setting before thrust reverser is applied;
- $L_{narrow_{seg}}$  Noise level at  $P_{narrow_{seg}}$  based on Approach NPDs; and
- $L_{wide_{seg}}$  Noise level at  $P_{wide_{seg}}$  based on Approach NPDs.

The engine power level during reverse thrust for a given segment is derived according to the following equations:

$$P_{unadj_{seg}} = \left[ \frac{d_{rev_{seg}}}{d_{rev}} \cdot (P_{60\%} - P_{10\%}) \right] + P_{10\%} \quad \text{Eq. 4-50}$$

$$P_{narrow_{seg}} = \left[ \frac{d_{rev_{seg}}}{d_{rev}} \cdot (P_{40\%} - P_{10\%}) \right] + P_{10\%} \quad \text{Eq. 4-51}$$

$$P_{wide_{seg}} = \left[ \frac{d_{rev_{seg}}}{d_{rev}} \cdot (P_{10\%} - P_{10\%}) \right] + P_{10\%} = P_{10\%} \quad \text{Eq. 4-52}$$

<sup>xxiii</sup> There is no thrust reverser adjustment for propeller-driven aircraft in AEDT.

where

- $P_{60\%}$  60% Max Thrust, which is the legacy reverse thrust implementation;
- $P_{40\%}$  40% Max Thrust, which is the current reverse thrust implementation for narrow-body aircraft;
- $P_{10\%}$  10% Max Thrust, which is the current reverse thrust implementation for wide-body aircraft;
- $d_{rev}$  The distance along the runway from the point of thrust reverser deployment to the end of the landing ground roll, where:  
 $d_{rev} = -0.9 \cdot s_{stop}$ ;
- $s_{stop}$  The location on the runway where the landing ground roll ends; and
- $d_{rev\_seg}$  The distance along the runway from the aircraft position to the end of the landing ground roll, where:

$$d_{rev\_seg} = -(300 + s_{stop} - d)$$

where

- $d$  Aircraft distance down the runway.

Engine power, aircraft speed, and reverse thrust levels for a standard landing ground roll are presented in Figure 4-12, where  $P_{rev}$  is 10% max thrust for wide-body aircraft, and  $P_{rev}$  is 40% max thrust for narrow-body aircraft. In both cases, the ending engine power setting is 10%.

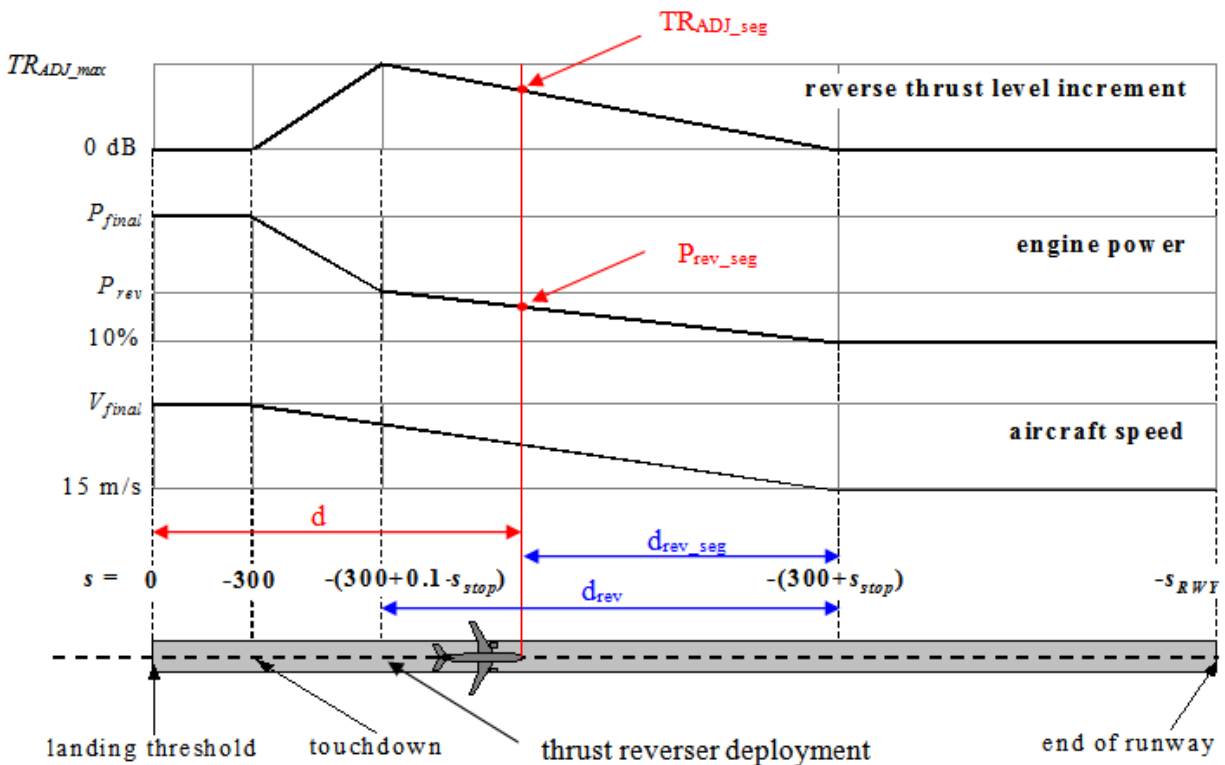

Figure 4-12 Modeling of Thrust Reverser Deployment During Landing Ground Roll

The thrust reverser adjustment in AEDT represents the most up-to-date method to model thrust reverser engine power levels used in the derivation of noise levels in an integrated model. Additional data collection and research efforts are ongoing and may result in future refinements.

#### 4.4.2 Ground-Based Directivity Adjustment ( $DIR_{ADJ}$ )

For the special case of computing noise behind the start-of-takeoff ground roll (SOTR), as well as for computing metrics associated with runup operations, field-measurement-based directivity adjustments are employed. This method replaces the SOTR noise directivity adjustment methods found in Section 3.3.1 (Sound Exposure Level Behind the Start-of-Takeoff Roll) of AIR1845A "Procedure for the Calculation of Airplane Noise in the Vicinity of Airports." The behind start of takeoff roll noise directivity method found in AIR1845A is based on measurements of older-generation (circa 1980), low by-pass ratio aircraft, primarily configured with fuselage-mounted engines and is applied to all aircraft in AEDT (except helicopters). The new method described is derived from empirical data from modern jet aircraft (circa 2004), most of which are configured with wing-mounted engines that tend to have higher by-pass ratios as well as operate at higher thrust levels. Additionally, the new method includes a separate directivity adjustment for propeller-driven aircraft.

These directivity adjustments are expressed as functions of azimuth angle,  $\theta$ , defined as the angle formed by the direction of the nose of the aircraft and the line connecting the aircraft to the receptor. The ground-based directivity adjustments used in AEDT are documented in SAE-AIR-6297 "Method to Calculate Behind Start of Takeoff Roll Noise Level Adjustments"<sup>34</sup>. Separate directivity adjustments are provided for jet and turboprop aircraft. The new jet SOTR directivity is applied for all jet aircraft (commercial and military), and the new turboprop SOTR directivity is applied for all propeller aircraft

(commercial and military for both turboprop and piston props). This is a fixed-wing aircraft adjustment, so no SOTR directivity is applied to helicopters.

To account for the effect of slight variations in the heading of the aircraft just prior to takeoff ground roll, among other effects, a directivity smoothing adjustment, computed as a function of slant range from the receptor location to the aircraft, is also applied.

The azimuth angle,  $\theta$  (degrees), used in computing the directivity adjustment, is given by:

$$\theta = \cos^{-1}\left(\frac{q}{r_1}\right) \quad \text{Eq. 4-53}$$

where

- q Relative distance between points  $P_1$  and  $P_s$  (ft) (by definition, the value of  $q$  is negative); and
- $r_1$  SLR<sub>seg</sub>, the slant range from the receptor to the start of the takeoff roll (ft).

Since the value of  $q$  is negative, and the value of SLR<sub>seg</sub> is positive, the value of  $\theta$  is greater than 90 degrees when the receptor is behind start of takeoff.

The directivity adjustment, DIR<sub>ADJ</sub>, for turbofan-powered jet aircraft is computed as a function of azimuth angle:

For  $\theta$  between 0 and 90 degrees,

$$DIR_{ADJ} = 0.0 \quad \text{Eq. 4-54}$$

For  $\theta$  between 90 and 180 degrees,

$$DIR_{ADJ} = 2329.44 - (8.0573 \cdot \theta) + (11.51 \cdot e^{(\pi \cdot \theta / 180)}) - \left(\frac{3.4601 \cdot \theta}{\ln(\pi \cdot \theta / 180)}\right) - \left(\frac{17403338.3 \cdot \ln(\pi \cdot \theta / 180)}{(\theta)^2}\right) \quad \text{Eq. 4-55}$$

The directivity adjustment, DIR<sub>ADJ</sub>, for turboprop-powered aircraft is computed as a function of azimuth angle:

For  $\theta$  between 0 and 90 degrees,

$$DIR_{ADJ} = 0.0 \quad \text{Eq. 4-56}$$

For  $\theta$  between 90 and 180 degrees,

$$\begin{aligned}
 DIR_{ADJ} = & -34643.898 + \left(\frac{30722162}{\theta}\right) - \left(\frac{11491573931}{\theta^2}\right) \\
 & + \left(\frac{2.34928567 \cdot 10^{12}}{\theta^3}\right) - \left(\frac{2.83584442 \cdot 10^{14}}{\theta^4}\right) \\
 & + \left(\frac{2.02271504 \cdot 10^{16}}{\theta^5}\right) - \left(\frac{7.90084471 \cdot 10^{17}}{\theta^6}\right) \\
 & + \left(\frac{1.30506872 \cdot 10^{19}}{\theta^7}\right)
 \end{aligned}
 \tag{Eq. 4-57}$$

The directivity adjustment is represented in decibels. The directivity adjustment is symmetric along the longitudinal axis of the aircraft in AEDT. This adjustment supplements the noise fraction adjustment for modeling noise from the start-of-takeoff ground roll,  $NF_{ADJ}$  (see Section 4.3.3).

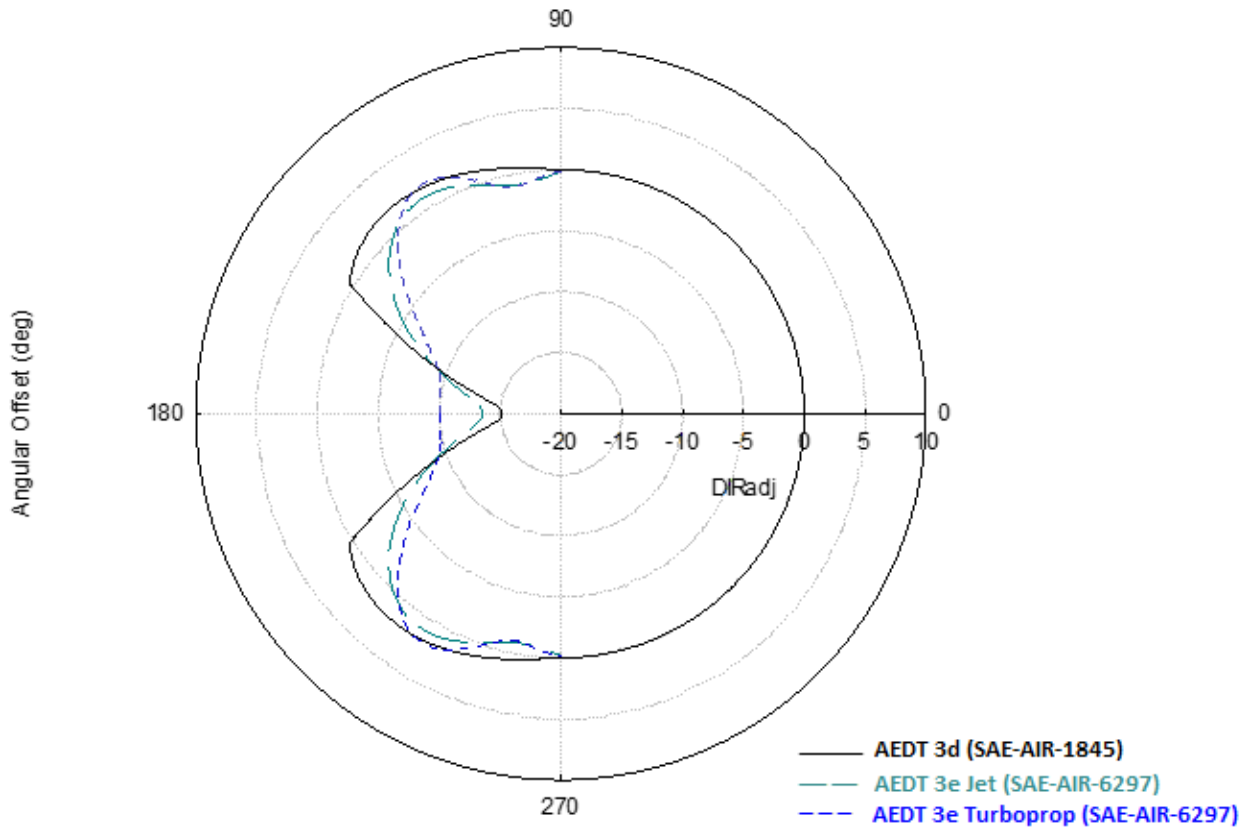

Figure 4-13 Ground-Based Directivity Adjustment for Turboprop-powered Jet Aircraft and Turboprop Aircraft

The directivity adjustment,  $DIR_{ADJ}$ , is modified by a smoothing equation that is computed as a function of slant range from the receptor location to start of takeoff,  $SLR_{seg}$ . The smoothing function is activated when  $SLR_{seg}$  is greater than 2,500 ft. The function, which reduces the directivity by a factor of 50% per doubling of distance, is given by:

$$DIR_{ADJ} = DIR_{ADJ} \cdot \left( \frac{2,500}{SLR_{seg}} \right) \quad SLR_{seg} > 2,500 \text{ feet} \quad \text{Eq. 4-58}$$

#### 4.4.3 Number of Engines Adjustment ( $NE_{ADJ}$ )

For the calculation of noise and emissions from runup operations for aircraft with thrust in units of pounds or percent, the user inputs the thrust and selects the number of engines used for the runup, ranging between 1 and the total number of engines on the ANP airplane. For aircraft with thrust in other units, the user cannot select the thrust or the number of engines. The highest NPD thrust and the total number of engines for the ANP aircraft are utilized for the calculations.

The number of engines adjustment,  $NE_{ADJ}$ , for runups by all airplanes is calculated according to the following equation:

$$NE_{ADJ} = 10 \log_{10} \left[ \frac{N}{N_{total}} \right] \quad \text{Eq. 4-59}$$

where

- $N$  Number of operative engines;
- $N_{total}$  Total number of engines of the operation's ANP aircraft.

## 4.5 Helicopter Adjustments

The sound level adjustments presented in this section are applicable only to helicopters. These adjustments include source noise due to advancing tip Mach Number ( $MN_{ADJ}$ ), Lateral Directivity ( $LD_{ADJ}$ ), static directivity ( $DIR_{HELI\_ADJ}$ ), and static operation duration ( $DUR_{HELI\_ADJ}$ ).

### 4.5.1 Source Noise Adjustment Due to Advancing Tip Mach Number ( $MN_{ADJ}$ , Level Flyover only)

This adjustment is necessary when the airspeed, temperature or rotor RPM deviates from the reference values. The adjustment is calculated using stored constants from a polynomial regression using the following equation:

$$MN_{ADJ} = B_0 + B_1 \cdot (M_{ADV_T} - M_{ADV_R}) + B_2 \cdot (M_{ADV_T} - M_{ADV_R})^2 \quad \text{Eq. 4-60}$$

where

- $B_0, B_1, B_2$  Helicopter specific coefficients;
- $V_T$  Operational airspeed (kts);
- $V_R$  Reference airspeed for the noise curve (kts); and
- $M_{ADV}$  Advancing tip Mach number, as defined by:

$$M_{ADV} = \frac{(1.688 \cdot V) + \left( \frac{\pi \cdot D \cdot RPM}{60} \right)}{c} \quad \text{Eq. 4-61}$$

where

- $V$  Airspeed (kts);

- D Blade diameter (ft);  
 RPM Blade rotations per minute; and  
 c Speed of sound in air (ft/s), as defined by:

$$c = 49.018 \cdot (459.63 + T)^{1/2} \quad \text{Eq. 4-62}$$

where

- T Temperature (F).

An example of the derivation of advancing tip Mach number adjustment from measured data can be found in the 1993 report "Noise Measurement Flight Test of Five Light Helicopters"<sup>35</sup>.

#### 4.5.2 Lateral Directivity Adjustment ( $LD_{ADJ}$ )

Helicopters are significantly more directive noise sources than fixed-wing aircraft. Helicopter in-flight directivity is implemented by using three sets of NPDs: left, center, and right (see Section 4.2.2.4). The left and right data are representative of the acoustic characteristics at a horizontal (to the side) elevation angle of 45 degrees; the center data are representative of the characteristics directly below the helicopter, or at 90 degrees. In cases where the elevation angle is between -45 and 45 degrees, a linear interpolation is performed on the observed elevation angle between the center NPD value and the left or right 45 degrees NPD value for all distances, which is reflected in the Lateral Directivity Adjustment ( $LD_{ADJ}$ ). The Lateral Directivity Adjustment is calculated according to the following equation:

$$LD_{ADJ} = (L_{Left\ or\ Right} - L_{Center}) \cdot \left( \frac{|\beta| - 90}{45 - 90} \right) \quad \text{Eq. 4-63}$$

where

- $L_{Left}$ ,  $L_{Center}$ ,  $L_{Right}$  Left, center, or right NPD data and  
 $\beta$  Observed elevation angle between 90 and 45 degrees on either side of the helicopter (see Figure 4-14).



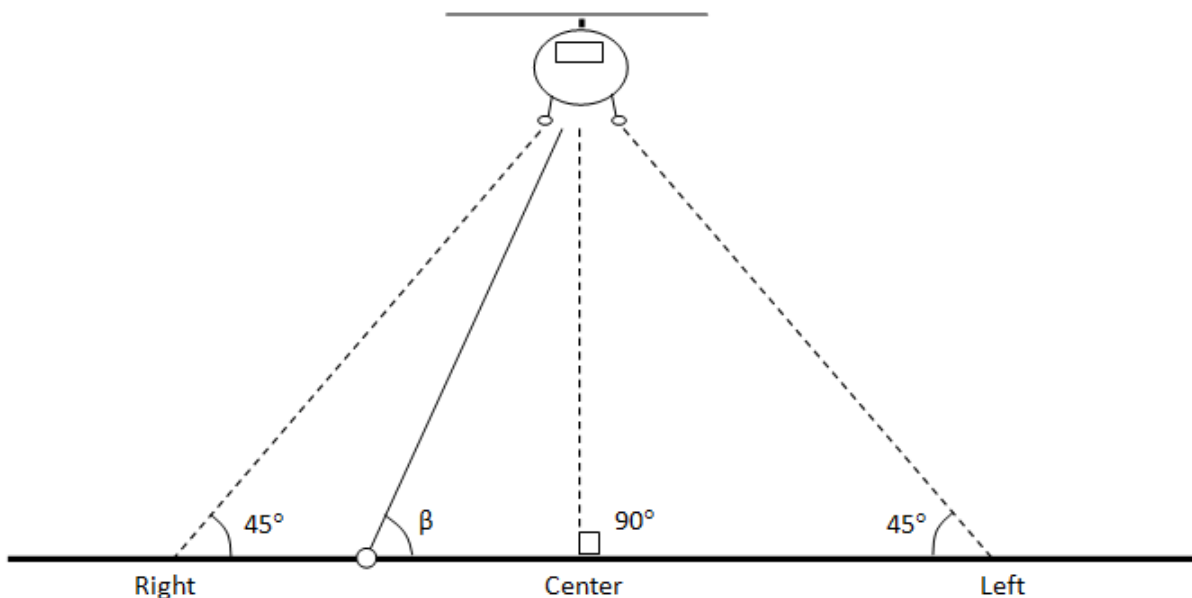

Figure 4-14 Elevation Angle for Helicopter Lateral Directivity Adjustment

For observed elevation angle less than 45 degrees on either side of the helicopter, no lateral directivity adjustment is applied, and the corresponding left or right NPD is used to determine the helicopter noise level. An example of the helicopter lateral directivity adjustment implementation is presented in Figure 4-14 for a dynamic operational mode; see Section 3.6.3 for a list of helicopter operational modes. An example of helicopter sound pressure levels according to elevation angle for a dynamic operational mode is shown in Figure 4-15.

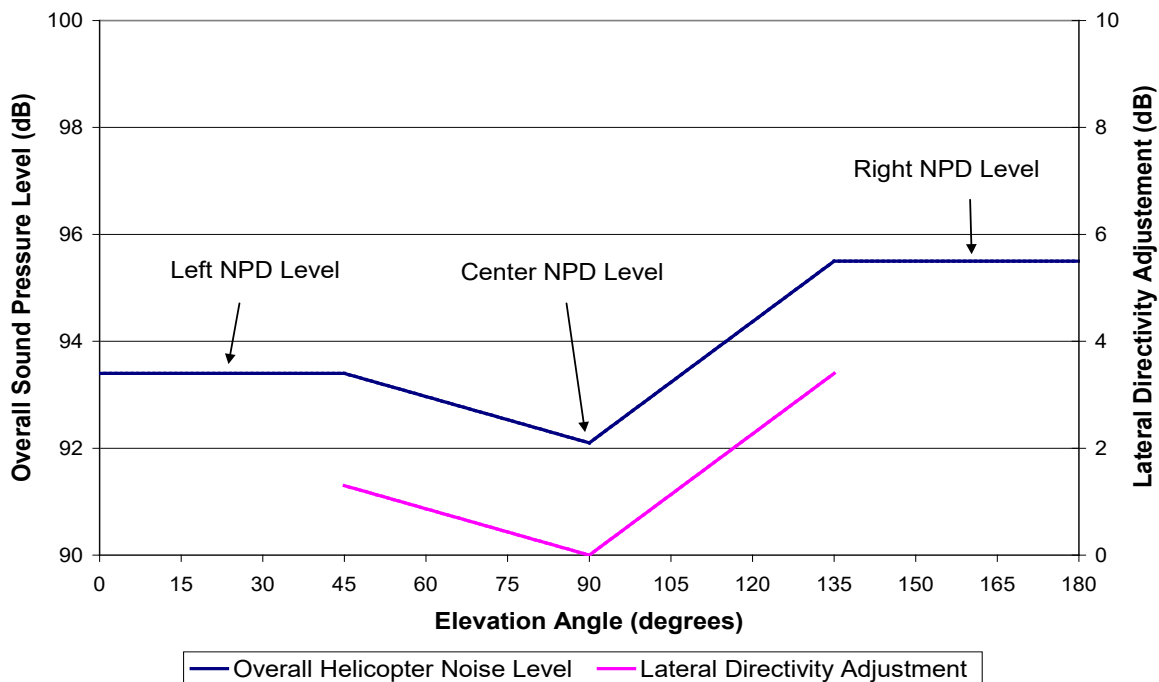

Figure 4-15 Example Helicopter Sound Pressure Levels According to Elevation Angle  
(Including Helicopter Lateral Directivity Adjustment)

#### 4.5.3 Static Directivity Adjustment ( $DIR_{HELI\_ADJ}$ )

The static directivity adjustment accounts for changes to the sound level as a function of the helicopter azimuth angle, which is measured clockwise from the nose. These adjustments are based on empirical data, and account for relative differences in sound level at different angles around the helicopter.  $DIR_{HELI\_ADJ}$  is only applied during static helicopter operations (Flight Idle, Ground Idle, HIGE, and HOGE). These data are helicopter-specific and included in the AEDT Fleet database, as described in Sections 2.2.1.1 and 2.2.1.3. Depending on data availability, different adjustments may be available for each of the four types of static helicopter operations<sup>xxiv</sup>.

#### 4.5.4 Static Operation Duration Adjustment ( $t_{HELI\_static}$ )

Helicopters can perform static operations along a flight track, and, as such, the duration of time spent on a segment during a static operation cannot be determined as a function of aircraft speed and segment length. Instead, the duration of a static event becomes a multiplier to the overall acoustical energy and is applied as the static operation duration adjustment once all the other general and helicopter adjustments have been applied (see Section 4.6.2.3).

<sup>xxiv</sup> In AEDT Fleet database, helicopters with no static directivity data have their static directivity adjustments set entirely to 0.0 dB.

## 4.6 Noise Computation

The single-event noise data described in Section 4.2 and the noise level adjustments described in Sections 4.3, 4.4, and 4.5 are used to compute the single-event noise values at the receptors. This includes the application of system (or study-wide) adjustments to interpolated NPD data (see Section 4.6.1), the computation of the single-event noise for the nine base metrics in the following categories: exposure-based noise level metrics  $L_{AE}$ ,  $L_{CE}$ , and  $L_{EPN}$  (see Section 4.6.2), the maximum noise level metrics  $L_{ASmx}$ ,  $L_{CSmx}$ , and  $L_{PNTSmx}$  (see Section 4.6.3), and the time-based metrics  $TA_{LA}$ ,  $TA_{LC}$ , and  $TA_{PNL}$  (see Section 4.6.4). The noise computations are run iteratively when additional base metrics are desired. Once all of the single events for an analysis have been computed for the applicable base metrics, then the single event results are accumulated across all of the events in the analysis, and the appropriate noise metrics are computed (see Section 4.6.5).

Figure 4-16 graphically summarizes the acoustic computation process employed in AEDT for computing noise from a single flight path segment (or runup or static operation) at a single receptor, when terrain processing is not selected. Figure 4-17 summarizes the same computation process, when terrain processing is selected.

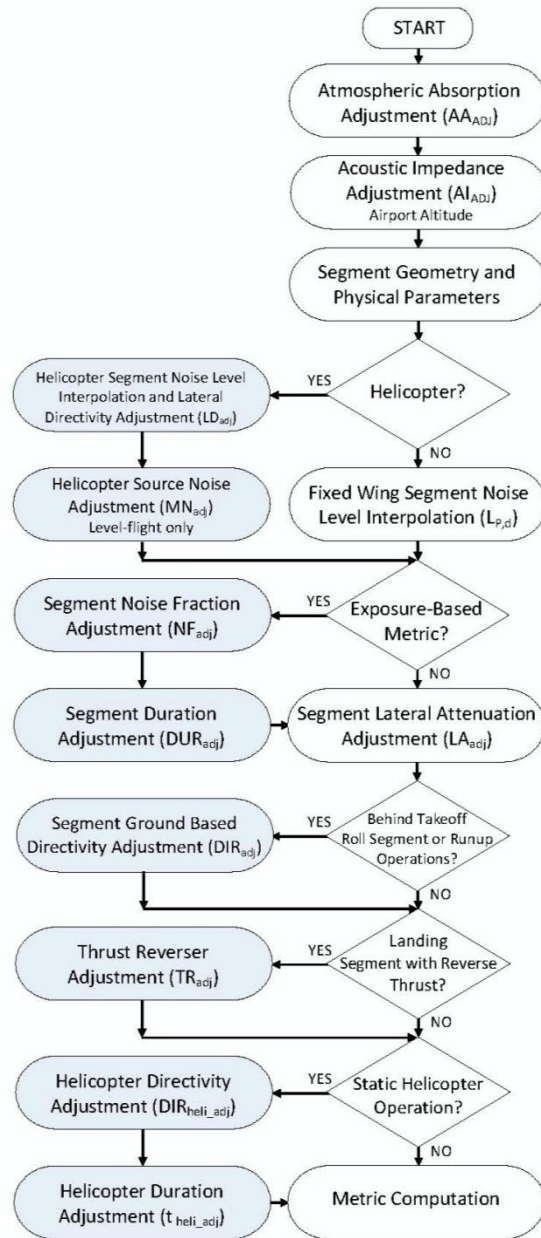

Figure 4-16 AEDT Acoustic Computation Process without Terrain for a Single Flight Segment

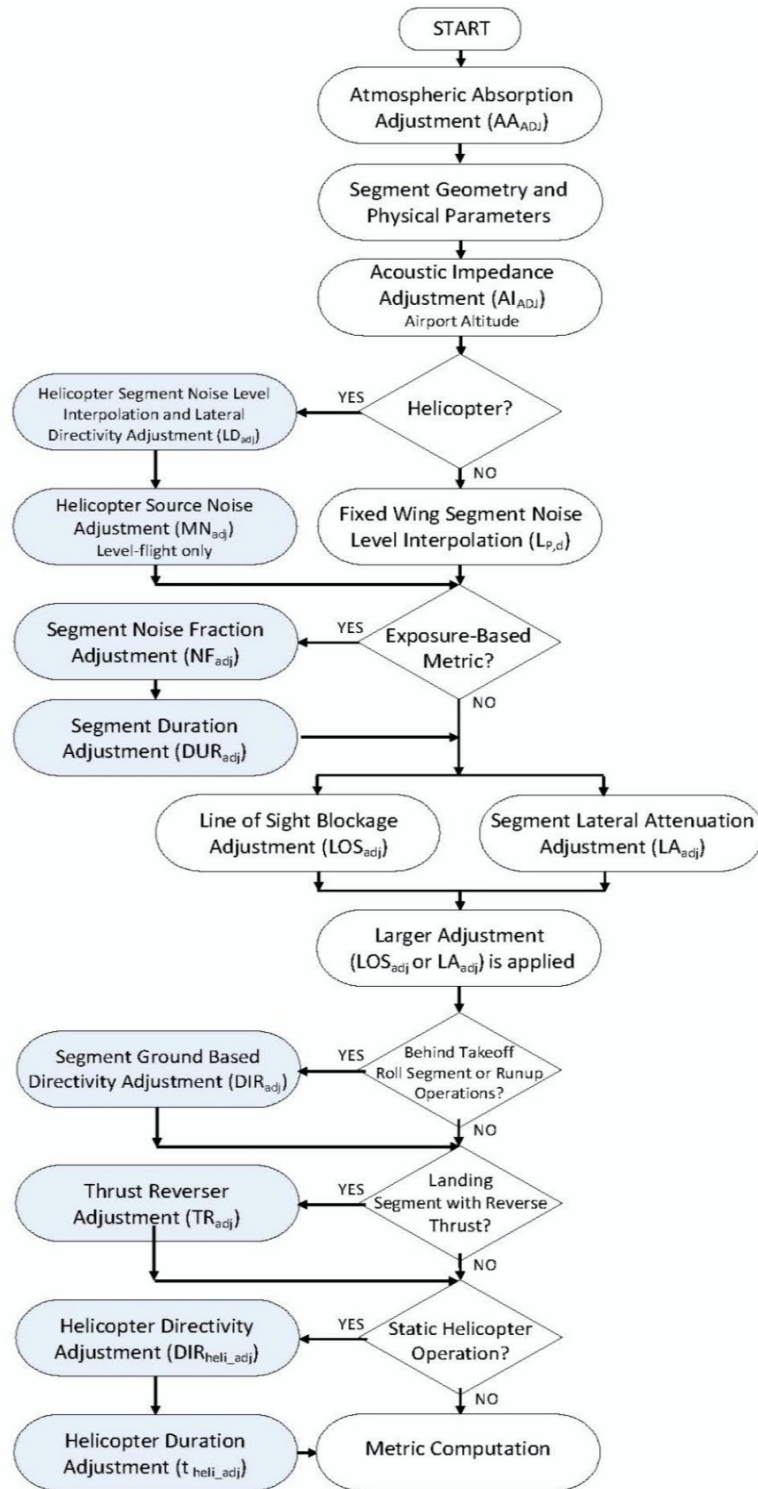

Figure 4-17 AEDT Acoustic Computation Process with Terrain for a Single Flight Segment

### 4.6.1 System Adjustments

AEDT applies study-wide adjustments to the interpolated NPD data. These adjustments include atmospheric absorption ( $AA_{ADJ}$ , Section 4.3.1) and acoustic impedance ( $AI_{ADJ}$ , Section 4.3.2). When terrain processing is not utilized in an analysis, both study-wide atmospheric absorption ( $AA_{ADJ}$ ) and acoustic impedance ( $AI_{ADJ}$ ) adjustments are applied to the NPD according to the following equations:

$$L_{E,P,d-ADJ} = L_{E,P,d} + [AA_{ADJ} + AI_{ADJ}]_{study-wide} \quad \text{Eq. 4-64}$$

$$L_{Smx,P,d-ADJ} = L_{Smx,P,d} + [AA_{ADJ} + AI_{ADJ}]_{study-wide} \quad \text{Eq. 4-65}$$

where

- $L_{E,P,d-ADJ}$   $L_{AE}$ ,  $L_{CE}$ , or  $L_{EPN}$ , in dB, resulting from the noise interpolation process using NPD data (see Section 4.2.2) and atmospheric absorption and acoustic impedance (see Sections 4.3.1 and 4.3.2);
- $L_{E,P,d}$  Exposure NPD level, in dB;
- $L_{Smx,P,d}$  Unadjusted,  $L_{ASmx}$ ,  $L_{CSmx}$ , or  $L_{PNTSmx}$ , in dB, resulting from the noise interpolation process (see Section 4.2.2), where the maximum noise level is computed at each segment end and the CPA, and the maximum of the three levels is used;
- $L_{Smx,P,d}$  Maximum NPD level, in dB;
- $AA_{ADJ}$  Atmospheric absorption adjustment, in dB (see Section 4.3.1); and
- $AI_{ADJ}$  Acoustic impedance adjustment, in dB (see Section 4.3.2).

When terrain processing is utilized in an analysis, the acoustic impedance adjustment ( $AI_{ADJ}$ ) is applied separately for each receptor, using the terrain elevation at the receptor's location instead of the airport elevation. For studies with terrain elevation processing, noise level interpolation is undertaken by first adjusting NPD curves using the study-wide atmospheric absorption adjustment ( $AA_{ADJ}$ ), and then the receptor location-specific acoustic impedance adjustment is added to the sound levels after noise level interpolation:

$$L_{E,P,d-ADJ} = L_{E,P,d} + [AA_{ADJ}]_{study-wide} + [AI_{ADJ}]_{per-receptor} \quad \text{Eq. 4-66}$$

$$L_{Smx,P,d-ADJ} = L_{Smx,P,d} + [AA_{ADJ}]_{study-wide} + [AI_{ADJ}]_{per-receptor} \quad \text{Eq. 4-67}$$

It is important to note that the atmospheric absorption adjustment ( $AA_{ADJ}$ ) is only applied in the noise computations if either the SAE-ARP-866A<sup>2</sup> or SAE-ARP-5534<sup>4</sup> option is selected. Otherwise, the default atmospheric absorption inherent in the NPDs in the AEDT Fleet database and described in SAE-AIR-1845<sup>3</sup> is used. Conversely, the acoustic impedance adjustment ( $AI_{ADJ}$ ) is always applied in the noise computations.

### 4.6.2 Computation of Exposure-Based Noise Level Metrics

The exposure-based metrics represent the total sound exposure for a given time period, often 24 hours, at a receptor location based upon average annual day conditions at an airport. AEDT standard sound exposure base metrics are:

$L_{AE}$	A-weighted sound exposure level (SEL);
$L_{CE}$	C-weighted sound exposure level (CEXP); and
$L_{EPN}$	Effective tone-corrected perceived noise level (EPNL).

This section presents the computation of exposure-based noise level metrics for both fixed wing aircraft flight operations (Section 4.6.2.1), including runup operations (Section 4.6.2.2) and helicopter flight operations (Section 4.6.2.3), including static operations (Section 4.6.2.4). To obtain the total noise exposure at a receptor location, the contributions from all the operations in an analysis (fixed-wing flight operations, runup operations, helicopter flight, and static operations) are combined (Section 4.6.5).

#### 4.6.2.1 Fixed-Wing Aircraft Flight Operations

For the exposure-based noise metrics, the sound exposure ratio due to a single fixed path segment of a flight operation for a fixed-wing aircraft, denoted by the symbol  $E_{seg}$ , is computed as follows:

$$E_{Seg} = 10^{\frac{[L_{E,P,d-ADJ} + NF_{ADJ} + DUR_{ADJ} - LA_{ADJ} + TR_{ADJ} + DIR_{ADJ}]}{10}} \quad \text{Eq. 4-68}$$

where

- $L_{E,P,d-ADJ}$   $L_{AE}$ ,  $L_{CE}$ , or  $L_{EPN}$ , in dB, resulting from the noise interpolation process using NPD data (see Section 4.2.2) and atmospheric absorption and acoustic impedance adjustments (see Section 4.3 and 4.6.1);
- $NF_{ADJ}$  Noise fraction adjustment, in dB (see Section 4.3.3);
- $DUR_{ADJ}$  Aircraft speed duration adjustment, in dB (see Section 4.3.4);
- $LA_{ADJ}$  Lateral attenuation adjustment, in dB (see Section 4.3.5);
- $TR_{ADJ}$  Thrust reverser adjustment, in dB, which is applied only if the fixed path segment is part of the landing ground roll during thrust reverser deployment (see Section 4.4.1); and
- $DIR_{ADJ}$  Directivity adjustment, in dB, which is applied only if the fixed path segment is part of takeoff ground roll (see Section 4.4.2).

If line-of-sight blockage is invoked,  $LA_{ADJ}$  is compared to line-of-sight blockage adjustment,  $LOS_{ADJ}$  (see Section 4.3.6), on a segment-receiver calculation-by-calculation basis, and the larger of the two values is applied to the calculations (in place of  $LA_{ADJ}$ ). If line-of-sight blockage is invoked, Equation Eq. 4-68 can be rewritten as:

$$E_{Seg} = 10^{\frac{[L_{E,P,d-ADJ} + NF_{ADJ} + DUR_{ADJ} - (\max[LOS_{ADJ}, LA_{ADJ}]) + TR_{ADJ} + DIR_{ADJ}]}{10}} \quad \text{Eq. 4-69}$$

where

- $LOS_{ADJ}$  Line-of-sight blockage adjustment, in dB (see Section 4.3.6).

The sound exposure ratio associated with each path segment in a flight operation is computed iteratively and preserved.

#### 4.6.2.2 Fixed-Wing Aircraft Runup Operations

For the exposure-based noise metrics, the mean-square sound-pressure ratio due to a single runup operation for a fixed-wing aircraft, denoted by the symbol  $P_{runup}$ , is computed as follows:

$$P_{runup} = 10^{\frac{[L_{Smx,P,d-ADJ} - LA_{ADJ} + DIR_{ADJ} + NE_{ADJ}]}{10}} \quad \text{Eq. 4-70}$$

where

$L_{Smx,P,d-ADJ}$	$L_{ASmx}$ , $L_{CSmx}$ , or $L_{PNtSmx}$ , in dB, resulting from the noise interpolation process using NPD data (see Section 4.2.2) and atmospheric absorption and acoustic impedance adjustments (see Section 4.3 and 4.6.1);
$DIR_{ADJ}$	Directivity adjustment, in dB (see Section 4.4.2);
$LA_{ADJ}$	Lateral attenuation adjustment, in dB (see Section 4.3.5); and
$NE_{ADJ}$	Number of engines adjustment, in dB (see Section 4.4.3).

If line-of-sight blockage is invoked,  $LA_{ADJ}$  is compared to line-of-sight blockage adjustment ( $LOS_{ADJ}$ ) on a segment-receiver calculation-by-calculation basis, and the larger of the two values is applied to the calculations:

$$P_{runup} = 10^{\frac{[L_{Smx,P,d-ADJ} - (\max[LOS_{ADJ}, LA_{ADJ}]) + DIR_{ADJ}]}{10}} \quad \text{Eq. 4-71}$$

where

$LOS_{ADJ}$	Line-of-sight blockage adjustment, in dB (see Section 4.3.6).
-------------	---

The sound exposure ratio due to a single runup operation for a fixed-wing aircraft,  $E_{runup}$ , takes into account time duration of the runup operation. The sound exposure ratio is computed as follows:

$$E_{runup} = \left( \frac{t_{runup}}{t_0} \right) \cdot P_{runup} \quad \text{Eq. 4-72}$$

where

$t_{runup}$	Runup duration (seconds); and
$t_0$	1 second for $L_{ASmx}$ or $L_{CSmx}$ , or 10 seconds for $L_{PNtSmx}$ .

The sound exposure ratio associated with each runup operation is computed iteratively and preserved.

#### 4.6.2.3 Helicopter Flight Operations

For the exposure-based noise metrics, the sound exposure ratio due to a single fixed path segment of a flight operation for a helicopter, denoted by the symbol  $E_{seg\_HELI}$ , is computed as follows:

$$E_{seg\_HELI} = 10^{\frac{[L_{E,P,d-ADJ} + NF_{ADJ} + DUR_{ADJ} - LA_{ADJ} + MN_{ADJ} + LD_{ADJ}]}{10}} \quad \text{Eq. 4-73}$$

where

$L_{E,P,d-ADJ}$	$L_{AE}$ , $L_{CE}$ , or $L_{EPN}$ , in dB, resulting from the noise interpolation process using NPD data (see Section 4.2.2) and atmospheric absorption and acoustic impedance adjustments (see Sections 4.3 and 4.6.1);
$NF_{ADJ}$	Noise fraction adjustment, in dB (see Section 4.3.3);
$DUR_{ADJ}$	Aircraft speed duration adjustment, in dB (see Section 4.3.4);
$LA_{ADJ}$	Lateral attenuation adjustment, in dB (see Section 4.3.5);



- $MN_{ADJ}$  Helicopter source noise adjustment, in dB (see Section 4.5.1); and  
 $LD_{ADJ}$  Lateral directivity adjustment for helicopters, in dB (see Section 4.5.2).

If line-of-sight blockage is invoked,  $LA_{ADJ}$  is compared to line-of-sight blockage adjustment ( $LOS_{ADJ}$ ) on a segment-receiver calculation-by-calculation basis, and the larger of the two values is applied to the calculations:

$$E_{seg\_HELI} = 10^{\frac{[L_{E,P,d-ADJ} + NF_{ADJ} + DUR_{ADJ} - (\max[LOS_{ADJ}, LA_{ADJ}]) + MN_{ADJ} + LD_{ADJ}]}{10}} \quad \text{Eq. 4-74}$$

where

- $LOS_{ADJ}$  Line-of-sight blockage adjustment, in dB (see Section 4.3.6).

The sound exposure ratio associated with each path segment in a helicopter flight operation is computed iteratively and preserved.

#### 4.6.2.4 Helicopter Static Operations

For the exposure-based noise metrics, the sound exposure ratio due to a static operation for a helicopter, denoted by the symbol  $E_{seg\_HELI\_static}$ , is computed as follows:

$$E_{seg\_HELI} = t_{HELI\_static} \cdot 10^{\frac{[L_{E,P,d-ADJ} + NF_{ADJ} - LA_{ADJ} + DIR_{HELI\_ADJ}]}{10}} \quad \text{Eq. 4-75}$$

where

- $t_{HELI\_static}$  Helicopter duration adjustment for static operations, in dB (see Section 4.5.4)  
 $L_{E,P,d-ADJ}$   $L_{AE}$ ,  $L_{CE}$ , or  $L_{EPN}$ , in dB, resulting from the noise interpolation process using NPD data (see Section 4.2.2) and atmospheric absorption and acoustic impedance adjustments (see Section 4.3 and 4.6.1);  
 $NF_{ADJ}$  Noise fraction adjustment, in dB (see Section 4.3.3);  
 $LA_{ADJ}$  Lateral attenuation adjustment, in dB (see Section 4.3.5); and  
 $DIR_{HELI\_ADJ}$  Helicopter directivity adjustment for static operations, in dB (see Section 4.5.3).

If line-of-sight blockage is invoked,  $LA_{ADJ}$  is compared to line-of-sight blockage adjustment ( $LOS_{ADJ}$ ) on a segment-receiver calculation-by-calculation basis, and the larger of the two values is applied to the calculations:

$$E_{seg\_HELI} = t_{HELI\_static} \cdot 10^{\frac{[L_{E,P,d-ADJ} + NF_{ADJ} - (\max[LOS_{ADJ}, LA_{ADJ}]) + DIR_{HELI\_ADJ}]}{10}} \quad \text{Eq. 4-76}$$

where

- $LOS_{ADJ}$  Line-of-sight blockage adjustment, in dB (see Section 4.3.6).

The sound exposure ratio associated with each static helicopter operation is computed iteratively and preserved.

#### 4.6.3 Computation of Maximum Noise Level Metrics

The maximum noise level metrics represent the maximum noise level at a receptor location, taking into account a particular set of aircraft operations.

AEDT standard maximum noise level base metrics are:

$L_{ASmx}$	Maximum A-weighted sound level with slow-scale exponential weighting characteristics (LAMAX);
$L_{CSmx}$	Maximum C-weighted sound level with slow-scale exponential weighting characteristics (LCMAX); and
$L_{PNTSmx}$	Maximum tone-corrected perceived noise level with slow-scale, exponential weighting characteristics (PNLTM).

This section presents separately the computation of maximum noise level metrics for aircraft flight operations (Section 4.6.3.1), including runup operations (Section 4.6.3.2), and helicopter flight operations (Section 4.6.3.3), including static operations (Section 4.6.3.4). To obtain the maximum noise level at a receptor location, the contributions from all the operations in an analysis (fixed wing flight operations and runup operations, and helicopter flight and static operations) are combined (Section 4.6.5).

#### 4.6.3.1 Fixed-Wing Aircraft Flight Operations

The maximum noise level due to a single flight path segment for a fixed wing aircraft,  $L_{Smx,seg}$ , is computed as follows:

$$L_{Smx,seg} = L_{Smx,P,d-ADJ} - LA_{ADJ} + TR_{ADJ} + DIR_{ADJ} \quad \text{Eq. 4-77}$$

where

$L_{Smx,P,d-ADJ}$	$L_{ASmx}$ , $L_{CSmx}$ , or $L_{PNTSmx}$ , in dB, resulting from the noise interpolation process (see Section 4.2.2), where the maximum noise level is computed at each segment end and the CPA, and the maximum of the three levels is used, along with atmospheric absorption and acoustic impedance adjustments (see Section 4.3 and 4.6.1);
$LA_{ADJ}$	Lateral attenuation adjustment, in dB (see Section 4.3.5);
$TR_{ADJ}$	Thrust reverser adjustment, in dB, which is applied only if the flight path segment is part of the landing ground roll during thrust reverser deployment (see Section 4.4.1); and
$DIR_{ADJ}$	Directivity adjustment, in dB, which is applied only if the flight path segment is part of takeoff ground roll (see Section 4.4.2).

If line-of-sight blockage is invoked,  $LA_{ADJ}$  is compared to line-of-sight blockage adjustment ( $LOS_{ADJ}$ ) on a segment-receiver calculation-by-calculation basis, and the larger of the two values is applied to the calculations (in place of  $LA_{ADJ}$ ). Therefore, if line-of-sight blockage is invoked, Eq. 4-77 can be rewritten as:

$$L_{Smx,seg} = L_{Smx,P,d-ADJ} - \max[LA_{ADJ}, LOS_{ADJ}] + TR_{ADJ} + DIR_{ADJ} \quad \text{Eq. 4-78}$$

where

$LOS_{ADJ}$	Line-of-sight blockage adjustment, in dB (see Section 4.3.6).
-------------	---

The maximum noise level associated with each path segment in a flight operation is computed iteratively and preserved.

#### 4.6.3.2 Fixed-Wing Aircraft Runup Operations

The maximum noise level due to a single runup operation, denoted by the symbol  $L_{Smx,runup}$ , is computed as follows:

$$L_{Smx,runup} = L_{Smx,P,d-ADJ} - LA_{ADJ} + DIR_{ADJ} + NE_{ADJ} \quad \text{Eq. 4-79}$$

where

- $L_{Smx,P,d-ADJ}$   $L_{ASmx}$ ,  $L_{CSmx}$ , or  $L_{PNTSmx}$ , in dB, resulting from the noise interpolation process (see Section 4.2.2), where the maximum noise level is computed at each segment end and the CPA, and the maximum of the three levels is used, along with atmospheric absorption and acoustic impedance adjustments (see Section 4.3 and 4.6.1);
- $LA_{ADJ}$  Lateral attenuation adjustment, in dB (see Section 4.3.5);
- $DIR_{ADJ}$  Directivity adjustment, in dB, which is applied only if the flight path segment is part of takeoff ground roll (see Section 4.4.2); and
- $NE_{ADJ}$  Number of engines adjustment, in dB (see Section 4.4.3).

If line-of-sight blockage is invoked,  $LA_{ADJ}$  is compared to line-of-sight blockage adjustment ( $LOS_{ADJ}$ ) on a segment-receiver calculation-by-calculation basis, and the larger of the two values is applied to the calculations:

$$L_{Smx,runup} = L_{Smx,P,d-ADJ} - \max[LA_{ADJ}, LOS_{ADJ}] + DIR_{ADJ} \quad \text{Eq. 4-80}$$

where

- $LOS_{ADJ}$  Line-of-sight blockage adjustment, in dB (see Section 4.3.6).

The maximum noise level associated with each runup operation is computed iteratively and preserved.

#### 4.6.3.3 Helicopter Flight Operations

The maximum noise level due to a single flight path segment for a helicopter,  $L_{Smx,seg\_HELI}$ , is computed as follows:

$$L_{Smx,seg\_HELI} = L_{Smx,P,d-ADJ} - LA_{ADJ} + MN_{ADJ} + LD_{ADJ} \quad \text{Eq. 4-81}$$

where

- $L_{Smx,P,d-ADJ}$   $L_{ASmx}$ ,  $L_{CSmx}$ , or  $L_{PNTSmx}$ , in dB, resulting from the noise interpolation process (see Section 4.2.2), where the maximum noise level is computed at each segment end and the CPA, and the maximum of the three levels is used along with atmospheric absorption and acoustic impedance adjustments (see Sections 4.3.1 and 4.6.1);
- $LA_{ADJ}$  Lateral attenuation adjustment, in dB (see Section 4.3.5);
- $MN_{ADJ}$  Helicopter source noise adjustment (see Section 4.5.1); and
- $LD_{ADJ}$  Lateral directivity adjustment for helicopters, in dB, (see Section 4.5.2).

If line-of-sight blockage is invoked,  $LA_{ADJ}$  is compared to line-of-sight blockage adjustment ( $LOS_{ADJ}$ ) on a segment-receiver calculation-by-calculation basis, and the larger of the two values is applied to the calculations:

$$L_{Smx,seg\_HELI} = L_{Smx,P,d-ADJ} - \max[LA_{ADJ}, LOS_{ADJ}] + MN_{ADJ} + LD_{ADJ} \quad \text{Eq. 4-82}$$

where

$LOS_{ADJ}$  Line-of-sight blockage adjustment, in dB (see Section 4.3.6).

The maximum noise level associated with each path segment of a helicopter flight operation is computed iteratively and preserved.

#### 4.6.3.4 Helicopter Static Operations

The maximum noise level due to a static operation for a helicopter, denoted by the symbol  $L_{Smx,HELI\_static}$ , is computed as follows:

$$L_{Smx,HELI\_static} = L_{Smx,P,d-ADJ} - LA_{ADJ} + DIR_{HELI\_ADJ} \quad \text{Eq. 4-83}$$

where

$L_{Smx,P,d-ADJ}$   $L_{ASmx}$ ,  $L_{CSmx}$ , or  $L_{PNTSmx}$ , in dB, resulting from the noise interpolation process (see Section 4.2.2), where the maximum noise level is computed at each segment end and the CPA, and the maximum of the three levels is used along with atmospheric absorption and acoustic impedance adjustments (see Sections 4.3 and 4.6.1);

$LA_{ADJ}$  Lateral attenuation adjustment, in dB (see Section 4.3.5);

$DIR_{HELI\_ADJ}$  Helicopter directivity adjustment for static operations, in dB (see Section 4.6.2.4).

If line-of-sight blockage is invoked,  $LA_{ADJ}$  is compared to line-of-sight blockage adjustment ( $LOS_{ADJ}$ ) on a segment-receiver calculation-by-calculation basis, and the larger of the two values is applied to the calculations:

$$L_{Smx,HELI\_static} = L_{Smx,P,d-ADJ} - \max[LA_{ADJ}, LOS_{ADJ}] + DIR_{HELI\_ADJ} \quad \text{Eq. 4-84}$$

where

$LOS_{ADJ}$  Line-of-sight blockage adjustment, in dB (see Section 4.3.6).

The maximum noise level associated with each helicopter static operation is computed iteratively and preserved.

#### 4.6.4 Computation of Time-Based Metrics

The time-based metrics represent the time (minutes) or percentage of time that the noise level is above a specified threshold, taking into account aircraft operations for a particular time period (e.g., 24 hours). The AEDT standard time-based base metrics are:

$TALA$	Time that the A-weighted noise level is above a user-defined sound level during the time period (TALA);
$TALC$	Time that the C-weighted noise level is above a user-defined sound level during the time period (TALC); and
$TAPNL$	Time that the tone-corrected perceived noise level is above a user specified noise level during the time period (TAPNL).

A subset of the time-based metrics is time audible. Time audible (or audibility) is computed based on a comparison of aircraft noise against ambient noise to determine the time duration (or percentage of

time duration) that the noise may be audible to a human observer. For these calculations, the observer is assumed to have normal hearing and to be actively listening for aircraft noise. Time audible also takes into account aircraft operations for a particular time period (e.g., 24 hours). The process is based on detectability theory and is supplemented with research that has assessed human auditory detectability in different environments. In order to represent these different environments, the time audible metrics require highly detailed inputs, including FAA AEE-approved ambient noise files. More details on ambient noise file requirements can be obtained by contacting FAA AEE (see Sections 2.2.3.6 and 2.2.3.7 for more information).

Section 11.1.5 provides additional specifics on the theory and background of the time audible computation. A detailed discussion of audibility calculations is also presented in the “Assessment of Tools for Modeling Aircraft Noise in the National Parks”<sup>31</sup>. AEDT standard time audible metrics are:

$T_{Aud}$	Time that aircraft are audible given study specific ambient noise (TAUD), and
$T_{AudSC}$	Time that aircraft are audible given study specific ambient noise with simultaneously occurring aircraft events (overlapping events) are accounted for with the statistical compression method (TAUDSC). Refer to Section 4.6.5.4.1 for description on the statistical compression method.

Time audible metrics may also be expressed as a percentage of time that aircraft are audible given study specific ambient noise during the analysis time period.

This section presents the computation of the time-based metrics for flight operations for fixed wing aircraft and helicopters (Section 4.6.4.1), as well as for ground operations (Section 4.6.4.2), which include both runup operations for fixed wing aircraft and static operations for helicopters. To obtain time-based metrics at a receptor location, the contribution from both flight operations and ground operations are combined. Although time audible takes into account adjusted noise levels for the flight and ground operations and a user-specified noise-level threshold like the other time-based metrics, the computation of time audible differs significantly from the other time-based metrics and is therefore presented separately (Section 4.6.4.3).

An important assumption inherent in time-based noise computations is that operations do not overlap in time, i.e., user-specified operations occur in a serial fashion. However, if a study includes operations occurring simultaneously (e.g., modeling an airport with parallel runways), the computed time-based noise metric may be larger than what would be measured at the airport. In such instances, a user could define operations in terms of equivalent numbers of serial operations, as compared with average annual day operations. In addition, the time audible metric includes the option to apply a statistical compression method that will account for the likelihood of overlapping events occurring in the final results (Section 4.6.5.4.1).

All time-based metrics computations in AEDT are referenced to a noise level threshold: either a fixed threshold level or a file of threshold or ambient values that may vary in noise level according to receptor location. The only caveat is for time audible, which may only be computed with a user-specified ambient file including both noise levels and spectra according to receptor location.

Time based metrics combine TALA, TAPNL, and TALC with Statistical Noise Compression, see Eq. 4-106:

$TA_{LASC}$	Time that the A-weighted noise level is above a user-defined sound level during the time period (TALA) with Statistical Noise Compression
$TA_{LCSC}$	Time that the C-weighted noise level is above a user-defined sound level during the time period (TALC) with Statistical Noise Compression; and
$TA_{PNLSC}$	Time that the tone-corrected perceived noise level is above a user specified noise level during the time period (TAPNL) with Statistical Noise Compression.

Statistical noise compression is applied after TALA, TAPNL, and TALC are computed.

#### 4.6.4.1 Flight Operations

In AEDT, the time-above metric ( $TA_{fit}$ , in minutes) can take the form of either the time above an A-weighted sound level ( $TA_{LA}$ ), the time-above a C-weighted sound level ( $TA_{LC}$ ), or the time above a tone-corrected perceived noise level ( $TA_{LPNT}$ ). TA is expressed in minutes and is computed on a per flight basis. TA due to a single flight operation (for both fixed wing aircraft and helicopters) is computed by the equation:

$$TA_{seg} = \begin{cases} \left(\frac{4}{\pi}\right) \cdot t_0 \cdot \left[10^{\frac{[L_{E,seg} - L_{Smx,seg}]}{10}}\right] \cdot \left[10^{\frac{[L_{Smx,seg} - L_0]}{20}} - 1\right]^{1/2} \cdot \frac{1}{60} & L_{Smx,seg} > L_0 \\ 0 & L_{Smx,seg} \leq L_0 \end{cases} \quad \text{Eq. 4-85}$$

where

$t_0$	1 second for $L_{AE}$ and $L_{CE}$ , or 10 seconds for $L_{EPN}$ ;
$L_{E,fit}$	Adjusted noise exposure level for the flight segment (dB), $L_{AE}$ , $L_{CE}$ , $L_{EPN}$ (Section 4.6.2);
$L_{Smx,fit}$	Adjusted maximum noise level for the flight segment (dB), $L_{ASmx}$ , $L_{CSmx}$ , $L_{PNTSmx}$ (where $L_{Smx,fit}$ must be larger than $L_0$ ) (Section 4.6.3); and
$L_0$	User-defined noise-level threshold (dB), expressed as A-weighted noise level, C-weighted noise level, or tone-corrected perceived noise level.

TA for each path segment of a flight operation is computed iteratively and the lesser of the computed value and the duration of the path segment is preserved.

#### 4.6.4.2 Ground Operations

The time-above metric for a single ground operation (either a runup operation for fixed wing aircraft or a static operation for helicopters) is the portion of the ground operation time during which the user-defined noise level threshold is exceeded by the ground operation noise. The time-above for a ground operation is computed as follows:

$$TA_{ground} = \begin{cases} t_{ground} & L_{Smx} > L_0 \\ 0 & L_{Smx} \leq L_0 \end{cases} \quad \text{Eq. 4-86}$$

where

$t_{ground}$	The time-above duration (minutes) of the ground operation event;
--------------	--

$L_{Smx}$	One of the tree types of adjusted maximum noise levels for ground operation (Section 4.6.3.2 for fixed wing aircraft and Section 4.6.3.4 for helicopters); and
$L_0$	The time-above noise threshold level.

TA for each runup operation is computed iteratively and preserved.

#### 4.6.4.3 Time Audible Computations

Audibility compares aircraft noise against background noise to determine if noise may be detected by a human observer with normal hearing who is actively listening for aircraft noise. The process is based on detectability theory along with research that has assessed human detectability under different environments. Audibility requires highly detailed inputs and results may be very sensitive to the quality of input data. Accounting for background noise requires ambient files.

There are four different time audible metrics: TAUD (Time Audible), TAUDP (Time Audible Percent), TAUDSC (Time Audible Statistical Compression), and TAUDPSC (Time Audible Percent Statistical Compression)<sup>36</sup>. All of these metrics are based on the base TAUD noise metric.

TAUD (in minutes) due to each aircraft segment is based on the computation of the total detectability level of that segment:

$$D' L_{total} = 10 \cdot \log_{10} [d'_{total}] \quad \text{Eq. 4-87}$$

where

$D' L_{total}$	the total detectability level of an aircraft segment, and
$d'_{total}$	the square root of the sum of squares of detectability over all frequency bands, as given by:

$$d'_{total} = \left[ \sum_{band=17}^{40} (d'_{band})^2 \right]^{1/2} \quad \text{Eq. 4-88}$$

$d'_{band}$	the detectability for each one-third octave frequency band:
-------------	---

$$d'_{band} = 10^{\frac{D' L_{band}}{10}} \quad \text{Eq. 4-89}$$

$D' L_{band}$	the detectability level for each one-third octave frequency band:
---------------	---

$$D' L_{band} = (L_{signal,band} - L_{noise,band}) + \{10 \cdot \log_{10} [\eta_{band}] + 0.5 \cdot 10 \cdot \log_{10} [bandwidth]\} \quad \text{Eq. 4-90}$$

where

$10 \log [\eta_{band}]$	one-third octave band specific constant;
bandwidth	the bandwidth of the one-third octave band; and

$L_{\text{noiseband}}$  the addition of the un-weighted, measured one-third octave band ambient levels and the appropriate Equivalent Auditory System Noise (EASN) level.

Specific constants utilized in the detectability equation are presented in Section 11.1.5.

Once the total detectability level has been determined, it is compared to the following detectability criteria:

$$\begin{aligned} D' L_{\text{total}} &\geq 7 && \text{the aircraft segment is detectable.} \\ D' L_{\text{total}} &< 7 && \text{the aircraft segment is not detectable.} \end{aligned} \quad \text{Eq. 4-91}$$

For each segment of the aircraft operation that is detectable, the time it takes aircraft to travel through that flight path segment is computed:

$$\text{segtime} = \left( \frac{\text{seglength}}{\text{segspeed}} \right) \cdot \# \text{ of operations} \quad \text{Eq. 4-92}$$

where

seglength	length (in feet) of contributing flight path segment;
segspeed	average speed (in feet/s) during contributing flight path segment; and
segtime	time passed during contributing flight path segment (s).

TAUD for each operation is computed iteratively and preserved.

Refer to Section 11.1.5 for a complete description of the time audible computation process.

#### 4.6.5 Accumulation of Noise Metric Computations

Once all of the noise is computed for each unique aircraft operation and flight path segment at each receptor in an AEDT analysis, the noise results are accumulated and the final noise results and the appropriate analysis metrics are computed. The weighting and averaging factors used to compute the 21 different noise metrics in AEDT, as well as user-defined noise metrics, are discussed in Section 4.6.5.1. The process for accumulating exposure-based noise level metrics from all the aircraft operations at all the receptors in an AEDT analysis is presented in Section 4.6.5.2. The process for accumulating maximum noise level metrics from all the aircraft operations at all the receptors in an AEDT analysis is presented in Section 4.6.5.3. The process for accumulating time-based noise metrics from all the aircraft operations at all the receptors in an AEDT analysis is presented in Section 4.6.5.4.

Figure 4-18 graphically summarizes the acoustic computation process employed in AEDT for accumulating noise from all the aircraft operations at all the receptors in an analysis.



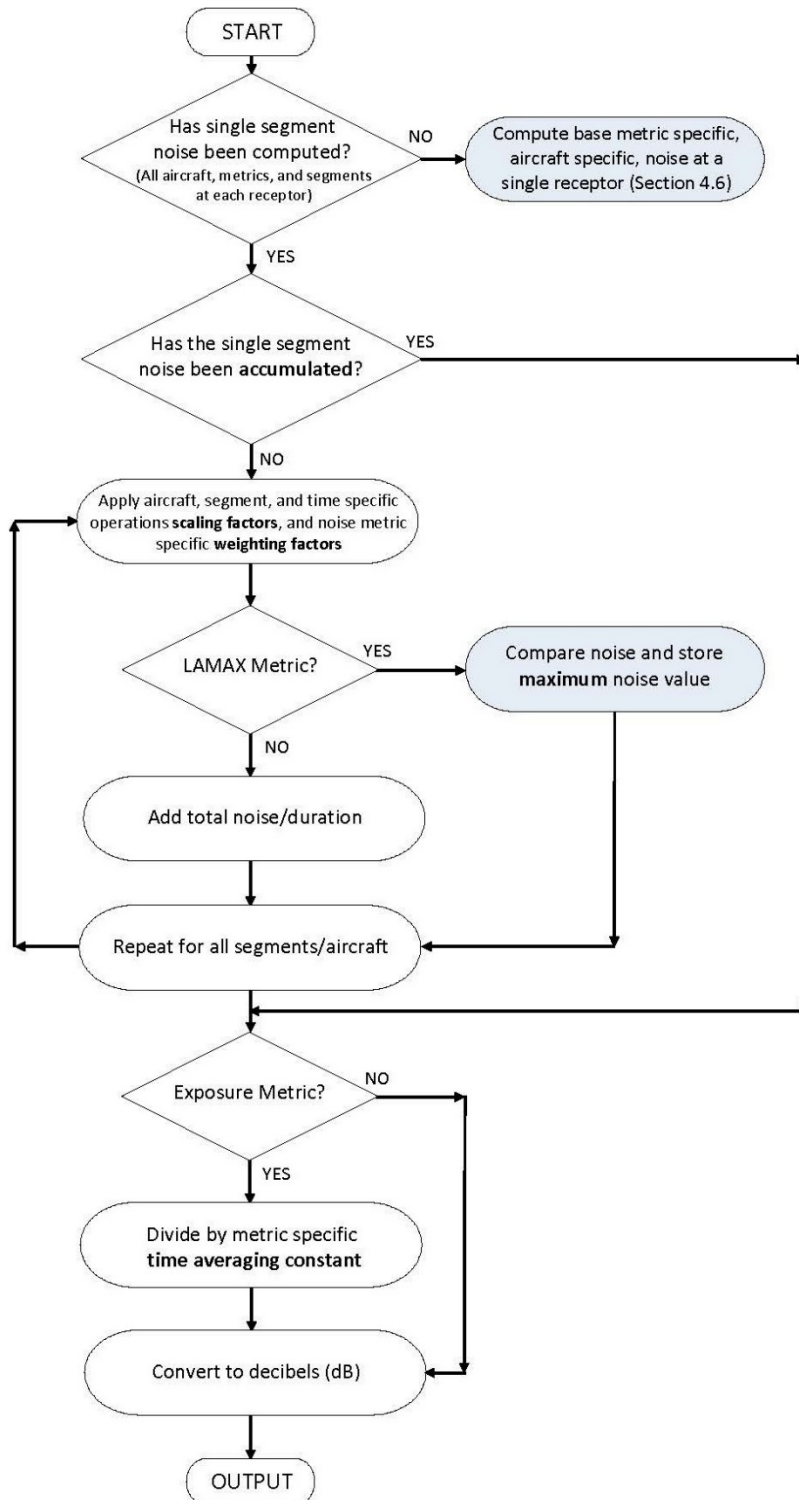

Figure 4-18 AEDT Accumulation of Acoustic Computation Process

#### 4.6.5.1 Noise Metric Weighting and Averaging Factors

As discussed in Section 2.2.1.1, there are four base noise level metrics:  $L_{AE}$ ,  $L_{ASmx}$ ,  $L_{EPN}$ , and  $L_{PNTSmx}$ . From those base metrics, AEDT can compute 21 different noise metrics and user-defined metrics. The metrics that can be computed in AEDT can be organized into three categories:

1. Exposure-based metrics, including change in exposure;
2. Maximum noise level metrics; and
3. Time-based metrics.

These 21 noise metrics are computed in AEDT by applying metric-specific, time-averaging constants and/or day, evening, and night-time weighting factors to the base metrics. The time-averaging constant applies a metric-specific duration factor to the noise metric. For exposure metrics, the weighting factor applies time-period-specific weightings (or penalties) to events that occur during those time periods. For the maximum-level and time-based metrics, the weighting factors are either zero or unity. As such, they act as a binary switch allowing the user to select specific time periods for computation.

In addition to AEDT standard metrics, user-defined metrics for the three families are available. A user specifies the time-averaging constant and the day, evening, and nighttime weighting factors. Although there are no standard average-level metrics in the C-weighted family because such metrics are not commonplace, the user has the ability to define user-specific C-weighted metrics.

The Number Above Noise Level metric represents an accumulated operation count above a noise threshold and is available for the A-Weighted metrics, SEL and LAMAX, and the C-Weighted metrics, CEXP and LCMAX. The day, evening and night weighting factors are equivalent to the base metric selected.

Table 4-2 summarizes associated weightings and averaging times.

Table 4-2 AEDT Noise Metric-Specific Weighting and Averaging Factors

Noise Family	Metric Type	Noise Metric	Weighting Factors			Averaging Time (hr)	Time-Averaging Constant ( $N_T$ )
			Day ( $W_{day}$ )	Evening ( $W_{eve}$ )	Night ( $W_{ngt}$ )		
A-Weighted	Exposure Based	SEL	1	1	1	-	1
		DNL	1	1	10	24	86,400
		CNEL	1	3 <sup>xxv</sup>	10	24	86,400
		LAEQ	1	1	1	24	86,400
		LAEQD	1	1	0	15	54,000

<sup>xxv</sup> In accordance with the technical definition, a 5 dB penalty is added to evening operations when computing the  $L_{den}$  noise metric. The 5 dB penalty, expressed in terms of a weighting factor, is equivalent to 3.16, not 3. However, in Title 21, Subchapter 6, §5001 of California state law a factor of 3 is used. Since the state of California is the primary user of the  $L_{den}$  metric, it was decided that AEDT would be consistent with state law, rather than the traditional technical definition. The evening weighting factor in the  $L_{WECPN}$  metric was changed to 3 for consistency. It is anticipated that this small difference will be of no practical consequence in the computations.

Noise Family	Metric Type	Noise Metric	Weighting Factors			Averaging Time (hr)	Time-Averaging Constant (N <sub>T</sub> )	
			Day (W <sub>day</sub> )	Evening (W <sub>eve</sub> )	Night (W <sub>ngt</sub> )			
		LAEQN	0	0	1	9	32,400	
		User-defined	A	B	C	T	T*3,600	
		NANL	1	1	1	-	1	
	Maximum Level	LAMAX	1	1	1	-	-	
		User-defined	A	B	C	-	-	
		NANL	1	1	1	-	-	
	Time-Based	TALA	1	1	1	-	-	
		TAUD	1	1	1	-	-	
		TAUDSC	1	1	1	-	-	
		TAUDP	1	1	1	-	-	
		TAUDPSC	1	1	1	-	-	
		TALASC	1	1	1	-	-	
		TAPNLSC	1	1	1	-	-	
		TALCSC	1	1	1	-	-	
	User-defined	A	B	C	-	-		
	C-Weighted	Exposure Based	CDNL	1	1	1	24	8,6400
			CEXP	1	1	1	-	-
			User-defined	A	B	C	T	T*3,600
			NANL	1	1	1	-	-
Maximum Level		LCMAX	1	1	1	-	-	
		User-defined	A	B	C	-	-	
		NANL	1	1	1	-	-	
Time-Based		TALC	1	1	1	-	-	
		User-defined	A	B	C	-	-	
Exposure Based		EPNL	1	1	1	-	1	
	NEF	1	1	16.7	24	630,957,345 <sup>xxvi</sup>		

<sup>xxvi</sup> The 630,957,345 value (88 dB = 10\*log<sub>10</sub>(630,957,345)) is a scaling constant inherent in the definition of the L<sub>NEF</sub> metric. A 24-hour period is used to compute the metric.

Noise Family	Metric Type	Noise Metric	Weighting Factors			Averaging Time (hr)	Time-Averaging Constant ( $N_T$ )
			Day ( $W_{day}$ )	Evening ( $W_{eve}$ )	Night ( $W_{ngt}$ )		
Tone-Corrected Perceived		WECPNL	1	3 <sup>xxvii</sup>	10	24	8,640 <sup>xxviii</sup>
		User-defined	A	B	C	T	T*3,600
	Maximum Level	PNLTM	1	1	1	-	-
		User-defined	A	B	C	-	-
	Time-Based	TAPNL	1	1	1	-	-
		User-defined	1	1	1	-	-

A, B, C, and T represent user-defined variables.

The metric-specific time-averaging constants and weighting factors are used to accumulate the noise metrics from all the aircraft operations at all the receptors in an AEDT analysis (Sections 4.6.5.2, 4.6.5.3, and 4.6.5.4).

#### 4.6.5.2 Accumulation of Exposure-based Noise Level Metrics

This section presents the accumulation of exposure-based noise level metrics for an AEDT analysis. Once the exposure-based noise levels from each flight path segment due to fixed-wing aircraft operations (Section 4.6.2.1 and 4.6.2.2) and helicopter operations (Section 4.6.2.3 and 4.6.2.4) are computed, the total noise exposure at a receptor location can be computed through the combination of all the individual flight path segment noise contributions at a receptor in an AEDT study.

Each flight in the case has an associated number of operations for the day, evening, and night-time periods. Also, depending upon the user-specified metric, each time period may have a weighting factor, i.e., a noise penalty, associated with it. The weighting factors for the standard exposure-based metrics, along with their associated time-averaging constants  $N_T$ , are summarized in Table 4-2, which also includes user-defined weighting factors and averaging constants.

The number of operations associated with each time period, coupled with the weighting factors, is used to compute the weighted sound exposure ratio, denoted by the symbol  $E_{wt,seg}$ , for a single Flight path segment and operation.

<sup>xxvii</sup> In accordance with the technical definition, a 5 dB penalty is added to evening operations when computing the  $L_{den}$  noise metric. The 5 dB penalty, expressed in terms of a weighting factor, is equivalent to 3.16, not 3. However, in Title 21, Subchapter 6, §5001 of California state law a factor of 3 is used. Since the state of California is the primary user of the  $L_{den}$  metric, it was decided that AEDT would be consistent with state law, rather than the traditional technical definition. The evening weighting factor in the  $L_{WECPN}$  metric was changed to 3 for consistency. It is anticipated that this small difference will be of no practical consequence in the computations.

<sup>xxviii</sup> The 8640 value is the number of 10-second intervals in a 24-hour period. Unlike  $L_{AE}$  and  $L_{CE}$ , which are normalized to a duration of  $t_0 = 1$  second,  $L_{EPN}$  is normalized to a duration of  $t_0 = 10$  seconds.

$$E_{wt,seg} = [W_{day} \cdot N_{day} + W_{eve} \cdot N_{eve} + W_{ngt} \cdot N_{ngt}] \cdot E_{seg} \quad \text{Eq. 4-93}$$

where

$N_{day}$	Number of user-specified operations between 0700 and 1900 hours local time;
$N_{eve}$	Number of user-specified operations between 1900 and 2200 hours local time;
$N_{ngt}$	Number of user-specified operations between 2200 and 0700 hours local time;
$W_{day}$	Day-time weighting factor, either standard or user-defined (see Table 4-2 for the standard weighting factors associated with a particular exposure-based noise level metric);
$W_{eve}$	Evening weighting factor, either standard or user-defined;
$W_{ngt}$	Night-time weighting factor, either standard or user-defined; and
$E_{seg}$	Sound exposure ratio at a receptor location due to a single flight path segment of a flight operation.

The weighted sound exposure ratio for each segment,  $E_{wt,seg(i)}$ , is computed iteratively and preserved.

The weighted sound exposure ratio due to an entire aircraft operation is obtained by summing the ratios associated with each segment in the flight path. The weighted sound exposure ratio for a flight operation,  $E_{wt,flt}$ , is computed as follows:

$$E_{wt,flt} = \sum_{i=1}^{n_{seg}} E_{wt,seg(i)} \quad \text{Eq. 4-94}$$

where

$n_{seg}$	Number of segments in the three dimensional flight path; and
$E_{wt,seg(i)}$	Weighted sound exposure ratio for the operation on the i-th segment of a flight path.

The weighted sound exposure ratio for all flight operations in the entire study case is obtained by summing the ratios associated with each flight operation. The weighted sound exposure ratio for all flight operations in the study case,  $E_{wt,arpt}$ , is computed as follows:

$$E_{wt,arpt} = \sum_{k=1}^{n_{flt}} E_{wt,flt(k)} \quad \text{Eq. 4-95}$$

where

$n_{flt}$	Number of flight operations in the study case; and
$E_{wt,flt(k)}$	Ratio of each flight operation.

The mean-square sound-pressure ratio associated with a specific exposure-based noise level metric is computed by dividing the weighted sound exposure ratio for the related base metric,  $E_{wt,arpt}$ , by a time-averaging constant  $N_T$ , either standard or user-defined. The time-averaging constants for the standard exposure-based metrics are summarized in Table 4-2. Note that three of the exposure-base metrics ( $L_{AE}$ ,  $L_{CE}$ , and  $L_{EPN}$ ) are true sound exposure levels and are not divided by a time-averaging constant (the time-

averaging constant is equal to 1). The average or equivalent mean-square sound-pressure ratio,  $P$ , associated with an exposure-based metric, is given by:

$$P_{wt,arpt} = \frac{E_{wt,arpt}}{N_T} \quad \text{Eq. 4-96}$$

The final step in the process is to convert  $P_{wt,arpt}$  to its equivalent decibel value. The decibel value for a user-defined, exposure-based metric due to all flight operations in an airport case is computed as follows:

$$L_{E,wt,arpt} = 10 \cdot \log_{10}[P_{wt,arpt}] \quad \text{Eq. 4-97}$$

$L_{E,wt,arpt}$  is a standard exposure-based noise level metric or a user-specified exposure-based metric, depending upon the specific weighting factors and time-averaging constants selected.  $L_{E,wt,arpt}$  is expressed in dB.

In addition to the above calculations, the single-event, sound exposure level,  $L_{E,flt}$ , for each flight operation is computed iteratively (without the day, evening, and night weighting factors) and saved for use in the time-above calculation (see Section 4.6.5.4).

$$L_{E,flt} = 10 \cdot \log_{10} \left[ \sum_{i=1}^{n_{seg}} E_{seg(i)} \right] \quad \text{Eq. 4-98}$$

#### 4.6.5.3 Accumulation of Maximum Noise Level Metrics

This section presents the accumulation of maximum noise level metrics for an AEDT analysis. Once the maximum noise level from each flight path segment due to fixed-wing aircraft operations (Sections 4.6.3.1 and 4.6.3.2), and helicopter operations (Sections 4.6.3.3 and 4.6.3.4) are computed, the maximum noise level at a receptor location can be computed through the analysis of all the individual flight path segment noise contributions at a receptor in an AEDT study.

The maximum noise level associated with each flight operation,  $L_{Smx,flt}$ , is determined by performing a flight-segment by flight-segment comparison of  $L_{Smx,seg}$  values, and preserving the largest value associated with each flight.  $L_{Smx,flt}$  is computed as follows:

$$L_{Smx,flt} = \underset{i=1}{\overset{n_{seg}}{\text{Max}}}[L_{Smx,seg(i)}] \quad \text{Eq. 4-99}$$

where

$n_{seg}$       Number of segments in the three-dimensional flight path.

The maximum noise level associated with each flight operation in the airport case,  $L_{Smx,flt(k)}$ , is computed iteratively and saved.

The  $L_{Smx,fit(k)}$  values are grouped according to the time period within which they occur, day, evening, or night. The maximum noise level associated with each time period,  $t$ , is computed as follows:

$$L_{Smx(t)} = \underset{k=1}{\overset{n_{fit(t)}}{\text{Max}}}[L_{Smx,fit(k)}] \quad \text{Eq. 4-100}$$

where

$n_{fit(t)}$  Number of flight operations in the study case for a given time period,  $t$ .

$L_{Smx}$  is computed for three time periods (day, evening and night). The maximum noise level equation is as follows:

$$L_{Smx} = \text{Max}[L_{Smx(day)} \cdot W_{day}, L_{Smx(eve)} \cdot W_{eve}, L_{Smx(ngt)} \cdot W_{ngt}] \quad \text{Eq. 4-101}$$

where

$\text{Max}[\ ]$  Function that returns the maximum of three noise level values;  
 $L_{Smx(day)}$  Maximum noise level for the time period between 0700 and 1900 hours local time;  
 $L_{Smx(eve)}$  Maximum noise level for the time period between 1900 and 2200 hours local time;  
 $L_{Smx(ngt)}$  Noise level for the time period between 2200 and 0700 hours local time;  
 $W_{day}$  Day-time weighting factor, either zero or one, depending on whether that time period is considered by the Max function;  
 $W_{eve}$  Evening weighting factor, either zero or one; and  
 $W_{ngt}$  Night-time weighting factor, either zero or one.

$L_{Smx}$  is equivalent to either the maximum A-weighted sound level, with slow-scale exponential weighting characteristics ( $L_{ASmx}$ ), the maximum C-weighted sound level, with slow-scale exponential weighting characteristics ( $L_{CSmx}$ ), or the tone-corrected maximum perceived noise level, with slow-scale exponential weighting characteristics ( $L_{PNTSmx}$ ).  $L_{Smx}$  is expressed in dB.

#### 4.6.5.4 Accumulation of Time-based Noise Metrics

This section presents the accumulation of time-based noise metrics for an AEDT analysis. Once the time-based noise from each flight path due to fixed-wing aircraft and helicopter operations (Sections 4.6.4.1 and 4.6.4.2) are computed, the time-based noise at a receptor location can be computed through the analysis of all the individual flight path noise contributions at a receptor in an AEDT study.

Each flight segment in the case has an associated number of operations for the day, evening, and night-time periods, along with weighting factors. In the case of the TA metric, the weighting factors act as binary switches, allowing the user to select/deselect specific time periods over which to compute TA. The number of operations associated with each time period and their assigned weighting factors are used to compute the weighted time-above value associated with an operation on a specific flight segment:

$$TA_{wt,seg} = [W_{day} \cdot N_{day} + W_{eve} \cdot N_{eve} + W_{ngt} \cdot N_{ngt}] \cdot TA_{seg} \quad \text{Eq. 4-102}$$

where

$N_{day}$	Number of user-specified operations between 0700 and 1900 hours local time;
$N_{eve}$	Number of user-specified operations between 1900 and 2200 hours local time;
$N_{ngt}$	Number of user-specified operations between 2200 and 0700 hours local time;
$W_{day}$	Day-time weighting factor, either zero or one, depending on whether that time period is considered;
$W_{eve}$	Evening weighting factor, either zero or one; and
$W_{ngt}$	Night-time weighting factor, either zero or one.

The weighted TA for each flight operation in the study case is computed iteratively and preserved.

The weighted TA due to an entire aircraft operation is obtained by summing the ratios associated with each segment in the flight path. The weighted TA for a flight operation,  $TA_{wt,flt}$ , is computed as follows:

$$TA_{wt,flt} = 10 \cdot \log_{10} \left[ \sum_{i=1}^{n_{seg}} TA_{wt,seg(i)} \right] \quad \text{Eq. 4-103}$$

where

$n_{seg}$	Number of segments in the three dimensional flight path; and
$TA_{wt,seg(i)}$	Weighted time above value for the operation on the i-th segment of a flight path, in minutes.

The time-above metric for all flight operations in the entire study case is then obtained by summing the  $TA_{wt,flt}$  values associated with each operation. The time above for all flight operations in the study case,  $TA_{wt,arpt}$ , is computed as follows:

$$TA_{wt,arpt} = \sum_{k=1}^{n_{flt}} TA_{wt,flt(k)} \quad \text{Eq. 4-104}$$

where

$n_{flt}$	Number of flight operations in the airport case.
-----------	--

TA is equivalent to either the time above an A-weighted sound level ( $TA_{LA}$ ), the time-above a C-weighted sound level ( $TA_{LC}$ ), or the time above a tone-corrected perceived noise level ( $TA_{LPNT}$ ), depending on the metric family selected, either the A-weighted, C-weighted, or the tone-corrected perceived. TA is expressed in minutes.

For percent of a time-based metric, the total time in minutes is divided by the user-defined time period of interest (in minutes) and multiplied by 100 to make percent.

#### 4.6.5.4.1 Additional Guidance for the Accumulation of Time Audible

Time audible is a cumulative metric accumulated in the same manner as time above, as the summation of all of the segtime values of an aircraft operation that are flagged as detectable. Therefore, time audible is computed according to:



$$TAud = TAud + segtime \quad \text{Eq. 4-105}$$

Once time audible has been computed iteratively with Eq. 4-105 for all detectable segments in the study case, the time audible (in minutes) for a time period will be:

$$TAud = \frac{TAud}{\left(60 \frac{\text{seconds}}{\text{minute}}\right)} \quad \text{Eq. 4-106}$$

Time above with statistical compression (TALASC, TAPNLSC, TALCSC) and Time audible with statistical compression (TAUDSC) are adjusted by a method to account for the effects of simultaneously occurring aircraft events on audibility. This method is known as the overlapping events method<sup>xxix</sup>. The overlapping events method is a statistically based adjustment developed by the [NPS Natural Sounds Program<sup>xxx</sup>](#), and is presented in the following equation:

$$y = N \cdot \left[ \frac{1 - e^{\left(-\frac{(N+1) \cdot x_{min}}{N \cdot T}\right)}}{N + 1} \right] \quad \text{Eq. 4-107}$$

where

- $x_{min}$  the uncorrected, cumulative TAUD results (minutes);
- $N$  the number of aircraft operations occurring during the analysis time; and
- $T$  the analysis time (minutes).

The effects of this method on TAUD are presented in Figure 4-19. Since the time compression algorithm takes into account number of operations, the time compression results are presented in Figure 4-19 for 0.1, 1, 10, 100, and 1,000 operations for a 24 hour analysis period.

<sup>xxix</sup> Formerly known as the “time compression method” and the “statistical compression method”.

<sup>xxx</sup> <https://www.nps.gov/subjects/sound/index.htm>

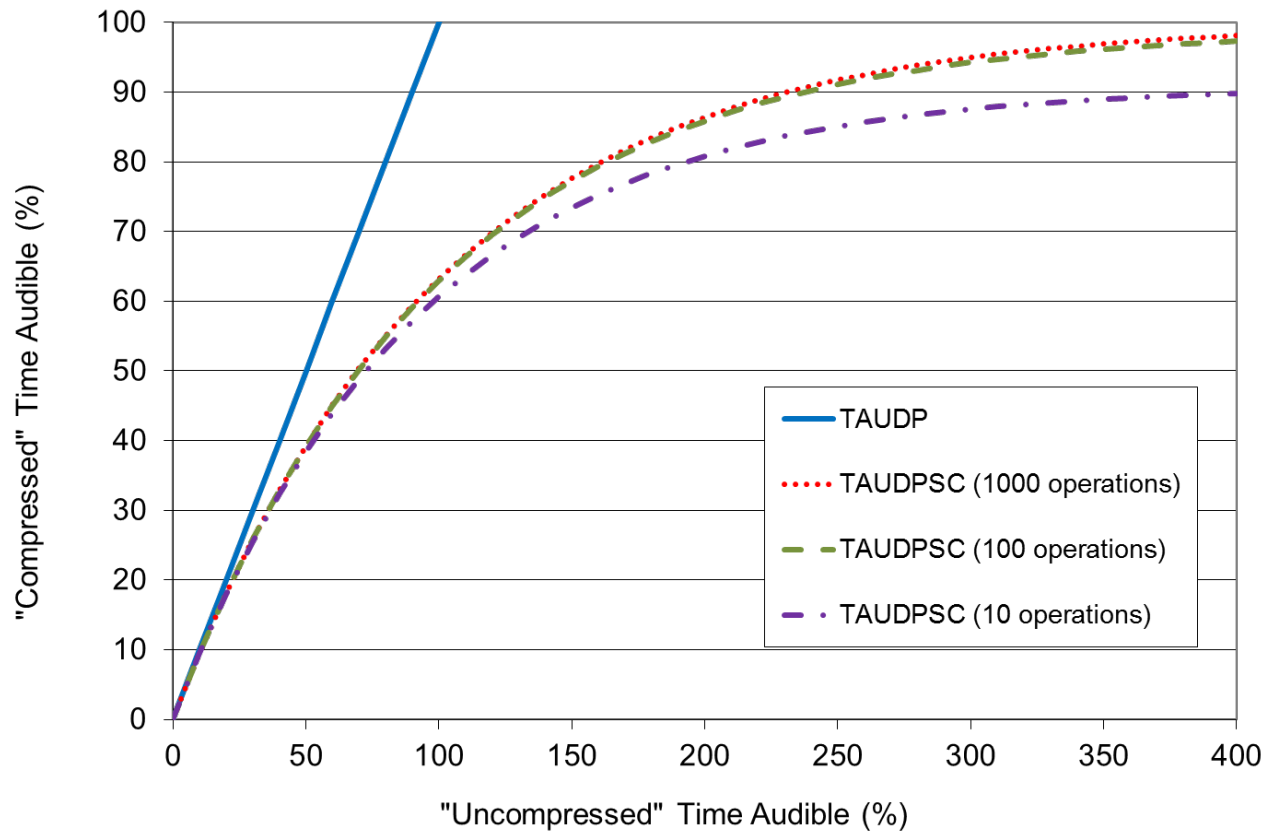

Figure 4-19 Uncompressed Time Audible

For percent time audible, the total time in minutes is divided by the user-defined time period of interest (in minutes) and multiplied by 100 percent.

Refer to Section 11.1.5 for a complete description of the time audible computation process.

#### 4.6.5.5 Accumulation of Number Above Noise Level Metric

The Number Above Noise Level metric represents the total count of operations (usually based on an average annual day) that exceed a user specified noise threshold, which is calculated from one of the four supported base metrics: SEL, LAMAX, CEXP, or LCMAX.

Noise from each operation is computed for the base metric as specified in sections 4.6.2 (Exposure) and 4.6.3 (Maximum level). The computed noise values are compared to a user defined decibel noise threshold. If the computed noise value is equal to or greater than the threshold, the scaled operation count is incremented and stored for each receptor.

### 4.7 Dynamic Grid Process

As noted in Section 2.2.1.6 on Receptor Sets, AEDT supports a special type of receptor set called a dynamic grid which offers the analyst two benefits: first, only the desired minimum noise level of interest is needed to set the geographic extent of the receptor set; second, the grid resolution will

automatically be increased where the spatial change of the noise increases. This ensures that the minimum noise level contour will close.

The dynamic grid process is applied when a dynamic grid receptor set is chosen for the noise metric result of interest. When the noise metric result is run, AEDT will automatically process the noise calculation to build up the dynamic grid receptor set. The controls which govern the dynamic grid process are:

- a. The initial receptor definition;
- b. The dynamic grid contour expansion level (minimum contour level to be closed);
- c. The dynamic grid algorithm;
- d. The refinement level limit; and
- e. The boundary extent (optional).

The dynamic grid is only discovered from these controls and the metric result definition when the metric result is run. Once the associated noise metric result has been run, the dynamic grid process stores the result as a point type receptor set. This resulting receptor set is then available for use in defining other metric results.

#### *Initial Receptor Definition*

The first control is set by defining an initial receptor in the Definitions tab, Receptors, followed by Definitions tab, Receptor Sets, to add the initial receptor as a dynamic grid to the new Receptor Set. The initial receptor should be defined as a grid that is not too big and not too small. A good guideline is to define that initial receptor to be a bounding box comprising a 2x2 grid that just contains the runways for the airport of interest. That initial receptor will be further refined automatically by AEDT until the spatial variation of the noise contour is smooth or the refinement level limit (defined below) is reached. The bounding box of the initial receptor grid also sets the minimum “step” size when expanding the dynamic grid to meet the second control. Note that this is the inverse of the concept of the recursive grid in INM, where the initial grid must be large enough to cover the noise contour of interest which is difficult to know before-hand.

#### *Dynamic grid contour expansion level*

The second control is set in the Study tab, Preferences, Dynamic Grid screen; and in the Define Metric Results wizard, Set Processing Options screen. In the Dynamic grid contour expansion level field, enter the lowest level noise contour of interest. AEDT will then grow the dynamic grid receptor set by expanding in all four directions one receptor grid (or “step”) at a time until that noise level is contained or the boundary (if defined) is reached.

#### *Dynamic grid algorithm*

The third control is set in the Study tab, Preferences, Dynamic Grid by choosing the algorithm used to evaluate the smoothness criteria of the resulting noise grid. There are two options: Linear INM Legacy and Second Order Laplacian.

- **Linear INM Legacy:** applies the same criteria for smoothness that was implemented in the INM recursive grid function (a first order difference between the evaluated noise and a linear interpolation of the noise).

- Second Order Laplacian: applies a second order difference criterion to the comparison between the evaluated noise and a quadratic interpolation of the noise and is more effective at refining the grid resolution, where the contour would change significantly.

Each algorithm has respective threshold values that can be set – Refine Tolerance for Linear INM Legacy and Curvature Difference Fraction for Second Order Laplacian.

Regardless of selected algorithm, the dynamic grid process attempts to refine the grid in any area where the evaluated criterion (linear or quadratic difference) exceeds the specified threshold. If so, the grid will be refined to the next higher level of resolution.

#### *Refinement level limit*

The fourth control is set in the Study tab, Preferences, Dynamic Grid. This allows the analyst to limit the number of refinement levels, regardless of the algorithm or smoothness of the noise process.

Refinement level is the number of times a grid will be subdivided. Subdividing a grid introduces five new points within the existing vertices of the grid: the existing grid is potentially sub-divided twice in each refinement level. A refinement level of two will further sub-divide the 25 (five squared) points created in the first step. Note that the number of points increases geometrically: the original grid has four points, the first subdivision has 25 points, second subdivisions has 81 points, and the third has 289 points. The number of points goes as  $(1+2^{(n+1)})^2$ , where n is the number of subdivision. The process will stop when either the refinement level limit is reached, or if the tolerances defined in the third control are reached.

#### *Use of a boundary (optional)*

This control is set in the Definitions tab, Receptor Sets when adding the initial receptor as a dynamic grid receptor set. When processing a receptor set that uses a boundary, the dynamic grid process is exactly as described above except that the geographic extent of the dynamic grid will stop once the boundary is reached (even if the minimum contour expansion level has not been reached). This may result in open contours. If the dynamic grid contour expansion level (minimum contour level) is computed within the boundary, processing will stop as soon as the level is reached.

## 4.8 Noise Combination

### 4.8.1 Overview

Noise combination of two computed acoustic results combines acoustics values of the same noise metric and produces a summed value at each receptor location of the two acoustic results. The acoustic value to add to a receptor (from one of the acoustics results) is calculated by interpolating a value in the other acoustics result at the location of the receptor. If this receptor does not occur within the polygon that encloses all receptors of the other acoustics result (i.e., the convex hull), then a value in the other acoustics result cannot be interpolated.

This technical description of the noise combination algorithm describes the combination of *two* acoustics results. AEDT allows combination of more than two acoustics results at once. This is performed by combining the first acoustics result with the second, producing a combined result set, followed by

combining the third acoustics result to the combined result set, producing a new combined result set, and so on until all of the acoustics results are combined.

The two options for combining the resultant receptor set are described in Section 4.8.7.

#### 4.8.2 Receptor Location Projection

AEDT stores acoustic result receptor locations in the World Geodetic System 84 (WGS 84) geographic coordinate system. The combination algorithm projects the locations into a two-dimensional (x, y) Cartesian coordinate system. Although AEDT allows for receptors to be defined with an associated AGL altitude dimension, the combination algorithm does not take AGL altitude into account.

The origin of the Cartesian coordinate system (i.e., the longitude and latitude that corresponds to (x, y) = (0, 0)) is selected to be the minimum longitude and minimum latitude observed in the first acoustic result receptor set. Once the projection origin has been established, the algorithm projects each longitude-latitude location into the two-dimensional Cartesian coordinate system.

#### 4.8.3 Acoustics Values at Receptors (Scaling)

The noise combination algorithm allows scaling of the acoustics values of the input acoustics results being combined. The exact numerical value that is scaled depends on the acoustics metric type. Metric types [with units of measure in brackets] are the following:

**Exposure-Based metrics [dB]:** Acoustics values are transformed from decibel to energy values, the energy value is multiplied by the scalar, and the scaled energy is transformed back into decibels.

**Maximum-Level metrics [dB]:** Acoustics values are transformed from decibel to energy values, the energy value is multiplied by a scalar, and the scaled energy is transformed back into decibels.

$$dB_{scaled} = 10 \cdot \log_{10}(10^{dB/10} \cdot s) \quad \text{Eq. 4-108}$$

where

$dB_{scaled}$	scaled noise value (dB);
$dB$	input noise value (dB);
$s$	scalar (dimensionless).

**Time-Above metrics [minutes]:** Acoustics values (in Minutes) are multiplied by a scalar.

$$t_{scaled} = t \cdot s \quad \text{Eq. 4-109}$$

where

$t_{scaled}$	scaled time-above value (minutes);
$t$	input time-above value (minutes);
$s$	scalar (dimensionless).

**Number-Above metrics [count]:** Count values are multiplied by a scalar.

$$n_{scaled} = n \cdot s$$

Eq. 4-110

where

$n_{scaled}$	scaled number-above value (dimensionless);
$n$	input number-above value (dimensionless);
$s$	scalar (dimensionless).

#### 4.8.4 Delaunay Triangulation

The noise combination algorithm resolves the receptor locations into a Delaunay triangulation. A general triangulation of a set of points in a two-dimensional plane involves connecting the points by straight line segments such that the set of points form the vertices of triangles. A two-dimensional Delaunay triangulation is a triangulation such that no point is within the circumcircle of any triangle in the triangulation.

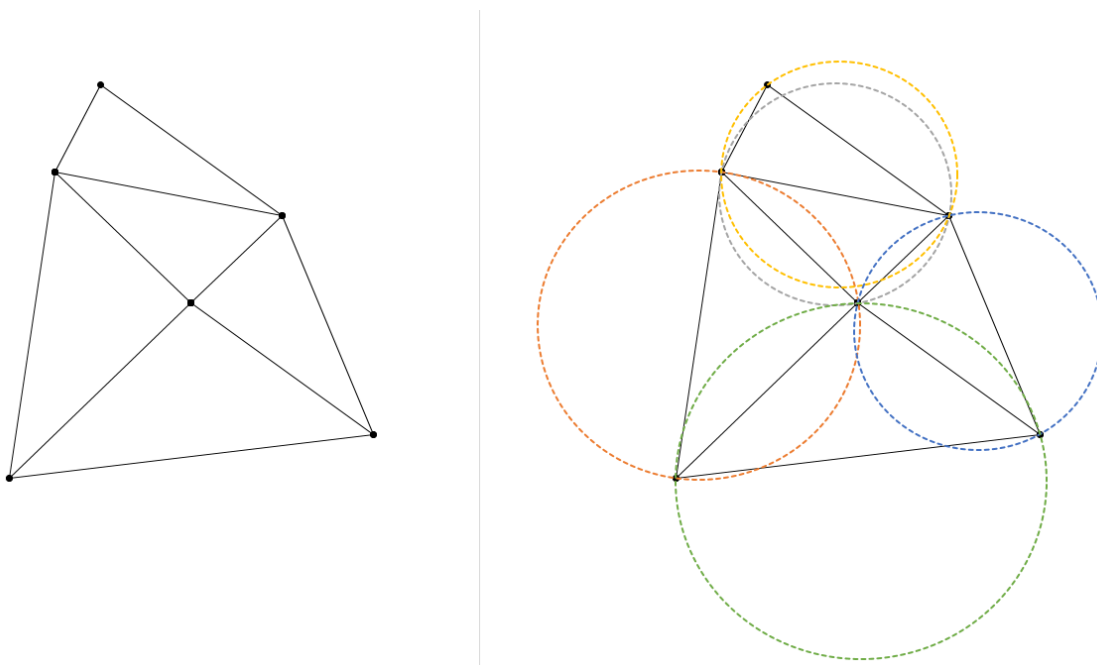

Figure 4-20 A Delaunay triangulation of a set of six input points (shown on the left). The five triangles produced by the triangulation each have circumcircles within which no input point exists (shown on the right).

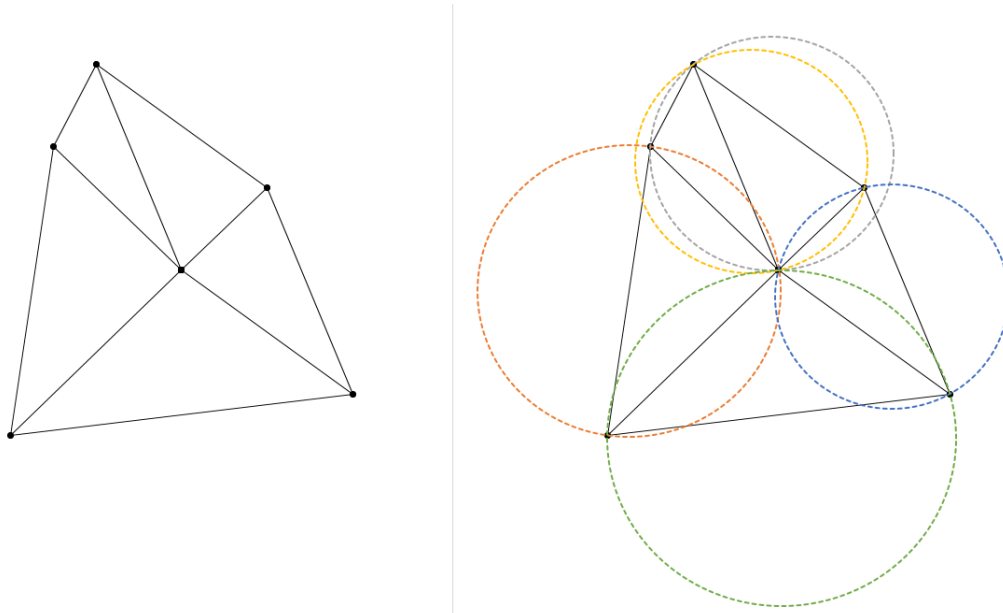

Figure 4-21 A triangulation of a set of six input points which is not a Delaunay triangulation. This fact is revealed by drawing the circumcircles of the five triangles and noticing that the upper two triangles each have an input point within their respective circumcircle.

#### 4.8.5 Triangulation Algorithm

The triangulation algorithm is composed of three steps:

- Construction of a bounding triangle: A sufficiently large bounding triangle is constructed and surrounds the triangulated surface.
- Addition of each input point: An input point is added to the triangulated surface being constructed. The addition of an input point into the triangulated surface splits one triangle into three.
- Check whether Delaunay condition is met: After each input point is added to the triangulated surface, check whether the three newly-generated triangles (and their three adjacent triangles) satisfy the Delaunay condition. The Delaunay condition is analogous to the circumcircle condition illustrated in the previous section.

A description of these steps is demonstrated with an example of three input points. These points are shown in the table below.

Table 4-3 Example Input Points

Point Name	X-Coordinate	Y-Coordinate	Noise Value (dB)
A	0	1	50
B	1	0	40
C	0.5	2	60

##### 4.8.5.1 Construct Bounding Triangle

A triangle that bounds the entire triangulated surface is generated. This bounding triangle is defined with respect to the maximum user coordinate. The maximum user coordinate is defined as the maximum of the absolute value of each input point x and y coordinate.

The three vertices of the bounding triangle are defined as the following:

$$\begin{aligned} v_1 &= ( 3.6c_{max} , 1.4c_{max}) \\ v_2 &= ( 0.028c_{max} , -2.4c_{max}) \\ v_3 &= ( -3.6c_{max} , 1.4c_{max}) \end{aligned} \quad \text{Eq. 4-111}$$

where

$c_{max}$	maximum user coordinate;
$v_1$	(x, y) coordinate of first vertex of bounding triangle;
$v_2$	(x, y) coordinate of second vertex of bounding triangle; and
$v_3$	(x, y) coordinate of third vertex of bounding triangle.

The multiplicative values that scale the maximum user coordinate in the bounding triangle vertex equations are arbitrary. The scalars guarantee to define a bounding triangle that surrounds the finished triangulated surface.

*Example:*

The maximum user coordinate for the three sample points is 2.

In this example, the size of the bounding triangle was modified to be slightly smaller. The bounding triangle ( $\overline{DEF}$ ) is shown in the figure below.

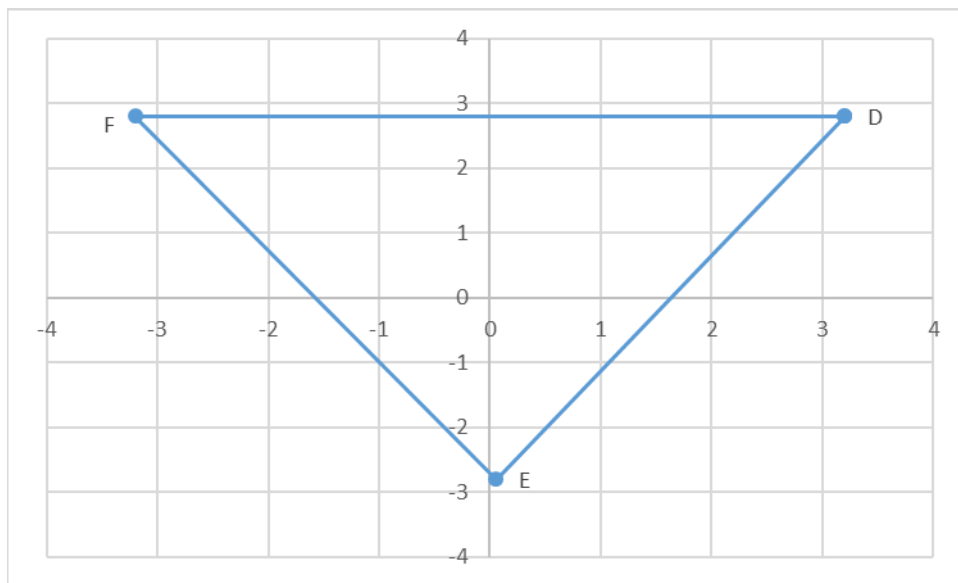

Figure 4-22 A bounding triangle is generated for each set of input points. The triangle  $\overline{DEF}$  is the bounding triangle generated for the input points A, B, and C.

#### 4.8.5.2 Add Each Input Point

Beginning with the bounding triangle, the triangulation algorithm adds each input point one at-a-time to the triangulated surface under construction. On each addition of an input point, the algorithm determines which already-existing triangle encloses the point that is to be added.



This enclosing triangle is determined by walking through and inspecting every already-existing triangle in the triangulation. When inspecting each triangle, the vertices of the triangle are analyzed in a clockwise fashion. When walked through in this manner, the enclosing triangle of the current point being input into the triangulation shall be the triangle whose sides are all to the left of the current point being input.

In order to determine which side of a line (from point  $p_1$  to point  $p_2$ , denoted by the symbol  $\overline{p_1p_2}$ ) an arbitrary point  $p$  is, the following equation is used:

$$(p_y - p_{1y})(p_{2x} - p_{1x}) - (p_x - p_{1x})(p_{2y} - p_{1y}) > 0 \begin{cases} \text{if true, } \overline{p_1p_2} \text{ is right of } p \\ \text{if false, } \overline{p_1p_2} \text{ is left of } p \end{cases} \quad \text{Eq. 4-112}$$

where

$p$	arbitrary point;
$p_x$	x-coordinate of $p$ ;
$p_y$	y-coordinate of $p$ ;
$p_1$	triangle vertex 1;
$p_{1x}$	x-coordinate of $p_1$ ;
$p_{1y}$	y-coordinate of $p_1$ ;
$p_2$	triangle vertex 2;
$p_{2x}$	x-coordinate of $p_2$ ; and
$p_{2y}$	y-coordinate of $p_2$ .

*Example:*

Since point A is the first point to be added, the only triangle in the triangulation is the bounding triangle  $\overline{DEF}$ . When the bounding triangle's vertices are walked clockwise, the three two-point lines formed by the vertices are all to the left of point A. Therefore, Point A is within the bounding triangle.

The original bounding triangle is replaced by three new triangles ( $\overline{ADF}$ ,  $\overline{ADE}$ , and  $\overline{AEF}$ ) as shown in the figure below.

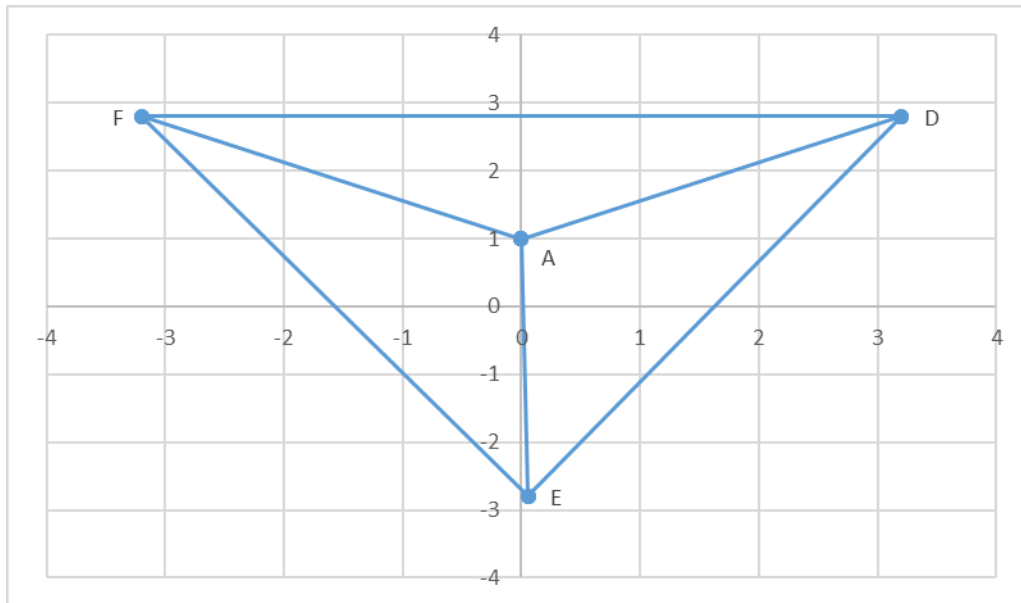

Figure 4-23 Input points are inserted into the triangulation one at-a-time. Each input point insertion replaces a triangle by three new triangles. The first point inserted (point A) replaces the triangle  $\overline{DEF}$ , by the three triangles  $\overline{ADE}$ ,  $\overline{ADF}$ , and  $\overline{AEF}$ .

Point B is determined to be in the triangle  $\overline{ADE}$ .  $\overline{ADE}$  is split into three new triangles ( $\overline{ABD}$ ,  $\overline{ABE}$ , and  $\overline{BDE}$ ) as shown in the figure below.

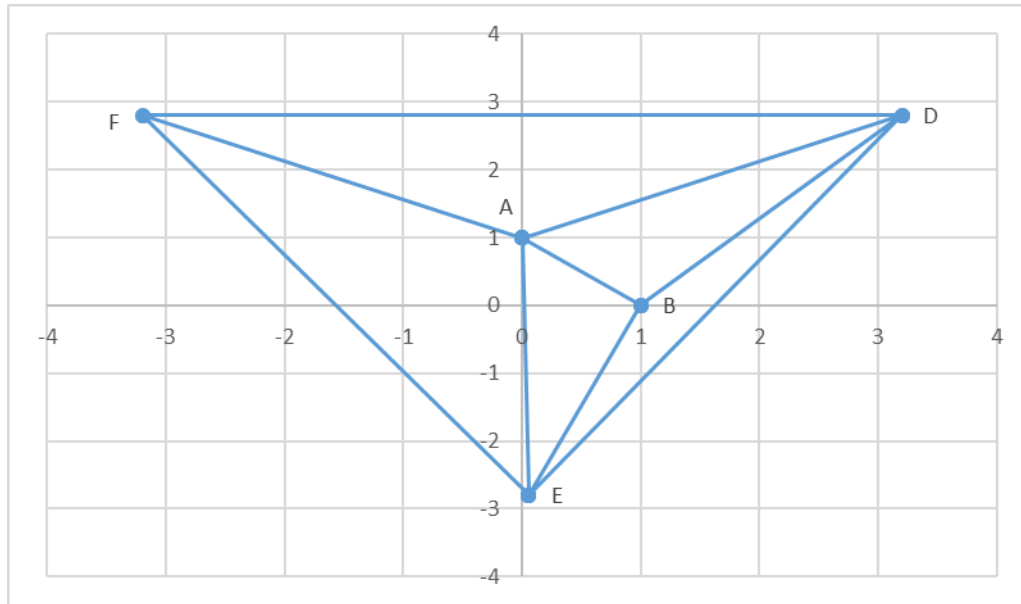

Figure 4-24 The insertion of point B replaces triangle  $\overline{ADE}$  by three new triangles ( $\overline{ABD}$ ,  $\overline{ABE}$ , and  $\overline{BDE}$ ).

#### 4.8.5.3 Potentially Flip Edges

Whenever a point is added to the triangulated surface there is a possibility that at least one of the three new triangles' circumcircles has an input point within its bounds. Triangles with circumcircles that contain input points within their bounds do not satisfy the Delaunay condition and must be redefined in order to do so.

The algorithm checks whether a pair of triangles satisfies the Delaunay condition. In total, on each input point insertion, each of the three new triangles is compared against their respective non-new adjacent triangle in order to determine whether the Delaunay condition is satisfied.

The figure below shows two adjacent triangles ( $\overline{ACD}$  and  $\overline{ABD}$ ). The Delaunay condition is satisfied if the circumcircle of the triangle  $\overline{ACD}$  does not contain point B and if the circumcircle of the triangle  $\overline{ABD}$  does not contain point C.

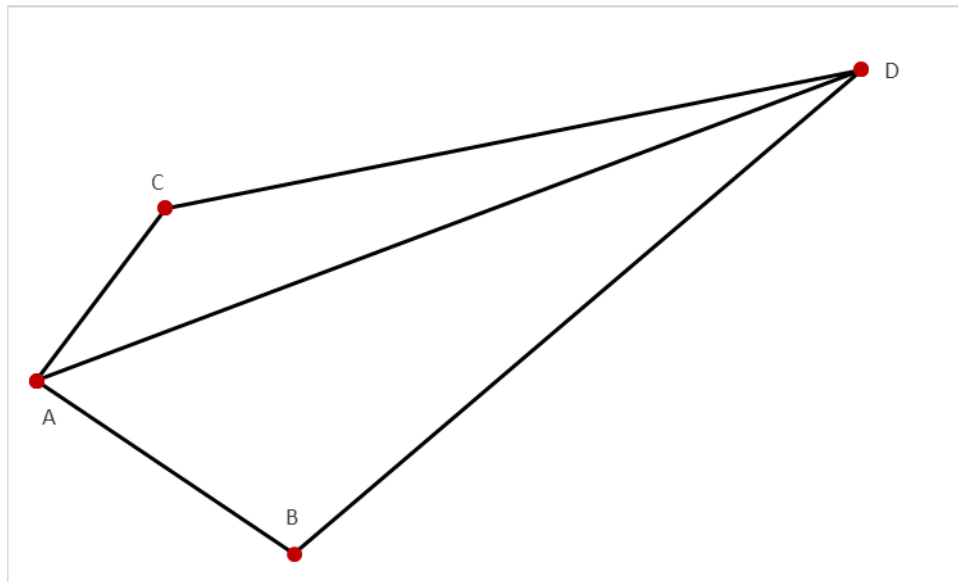

Figure 4-25 Two adjacent triangles that are checked for satisfaction of the Delaunay condition. The check determines whether the side  $\overline{AD}$  must be flipped to  $\overline{BC}$  and replace the triangles  $\overline{ABD}$  and  $\overline{ACD}$  by the triangles  $\overline{ABC}$  and  $\overline{BCD}$ .

The following conditions determine whether the connection between point A and point D should be flipped to be between point B and point C in order to satisfy the Delaunay condition.

$$u_3 u_4 \leq 0 \text{ or } \frac{\min(s_1, s_2)}{\min(s_3, s_4)} < 1 \begin{cases} \text{if true, } \overline{AD} \text{ needs to be exchanged to } \overline{BC} \\ \text{if false, } \overline{AD} \text{ does not need to be exchanged to } \overline{BC} \end{cases} \quad \text{Eq. 4-113}$$

where

$A$	vertex A
$x_A$	x-coordinate of vertex A
$y_A$	y-coordinate of vertex A
$B$	vertex B
$x_B$	x-coordinate of vertex B
$y_B$	y-coordinate of vertex B
$C$	vertex C
$x_C$	x-coordinate of vertex C
$y_C$	y-coordinate of vertex C
$D$	vertex D
$x_D$	x-coordinate of vertex D
$y_D$	y-coordinate of vertex D
$u_1$	$(y_C - y_A)(x_D - x_A) - (x_D - x_A)(y_D - y_A)$
$u_2$	$(y_D - y_B)(x_C - x_B) - (x_D - x_B)(y_C - y_B)$
$u_3$	$(y_B - y_C)(x_A - x_C) - (x_B - x_C)(y_A - y_C)$
$u_4$	$(y_A - y_D)(x_B - x_D) - (x_A - x_D)(y_B - y_D)$
$i_1$	$(x_A - x_C)^2 + (y_A - y_C)^2$

$$\begin{aligned}
 j_1 & (x_D - x_A)^2 + (y_D - y_A)^2 \\
 k_1 & (x_C - x_D)^2 + (y_C - y_D)^2 \\
 i_2 & (x_B - x_D)^2 + (y_B - y_D)^2 \\
 j_2 & (x_C - x_B)^2 + (y_C - y_B)^2 \\
 k_2 & (x_B - x_A)^2 + (y_B - y_A)^2 \\
 s_1 & u_1^2 / (k_1 \cdot \max(i_1, j_1)) \\
 s_2 & u_2^2 / (k_1 \cdot \max(i_2, j_2)) \\
 s_3 & u_3^2 / (k_2 \cdot \max(j_2, i_1)) \\
 s_4 & u_4^2 / (k_2 \cdot \max(j_1, i_2))
 \end{aligned}$$

Example:

Point C is determined to be within triangle  $\overline{ADF}$ . Triangle  $\overline{ADF}$  is replaced by three new triangles ( $\overline{ACD}$ ,  $\overline{CDF}$ , and  $\overline{ACF}$ ).

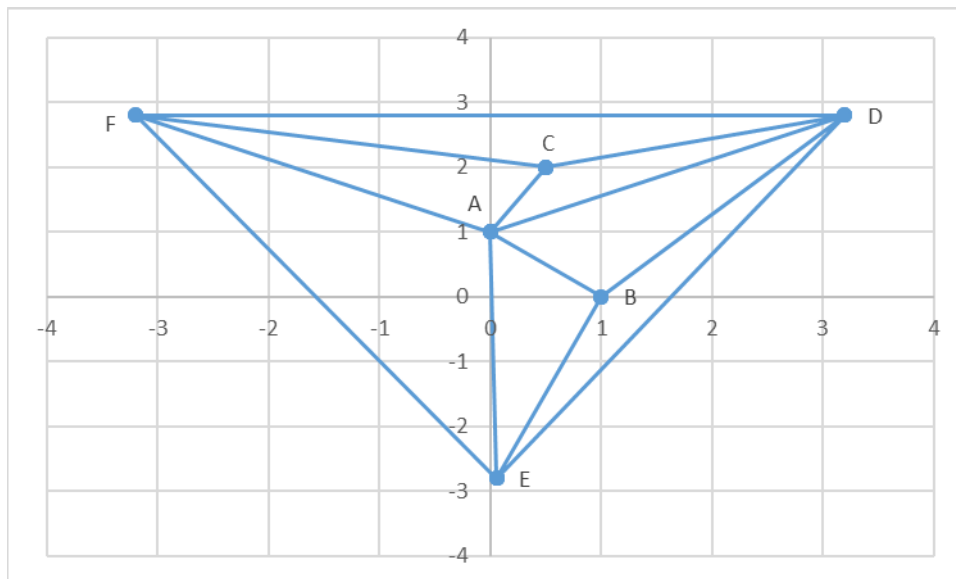

Figure 4-26 The insertion of point C replaces triangle  $\overline{ADF}$  by three new triangles ( $\overline{ACD}$ ,  $\overline{ACF}$ , and  $\overline{CDF}$ ).

Each of the three new triangles are checked in order to determine whether they satisfy the Delaunay condition. Each new triangle is compared against the single triangle with which it shares an edge that is not one of the two other new triangles.  $\overline{ACD}$  is compared against  $\overline{ABD}$ ,  $\overline{ACF}$  is compared against  $\overline{AEF}$ , and  $\overline{CDF}$  does not have a complimentary triangle to be compared against since it is on the edge of the triangulation. The comparison determines that the triangles  $\overline{ACD}$  and  $\overline{ABD}$  do not satisfy the Delaunay condition. Their common side of  $\overline{AD}$  must be flipped to  $\overline{BC}$  as shown in the figure below.

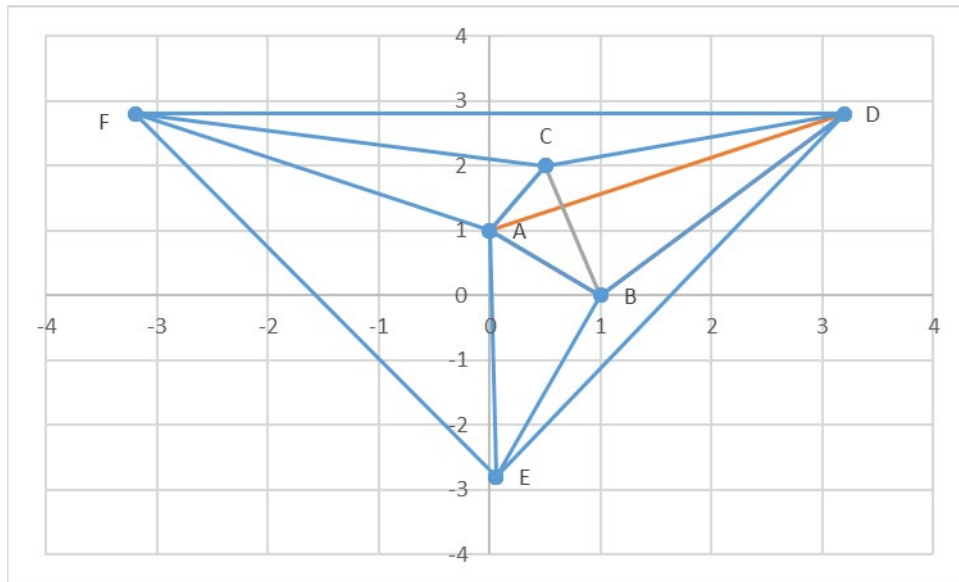

Figure 4-27 A check on the insertion of point C determines that triangles  $\overline{CDF}$  and  $\overline{CDB}$  do not satisfy the Delaunay condition. The common side  $\overline{AD}$  (shown in orange) must be changed to  $\overline{BC}$  (shown in gray). The triangles  $\overline{ABD}$  and  $\overline{ACD}$  are redefined to  $\overline{ABC}$  and  $\overline{BCD}$

#### 4.8.6 Interpolation

A triangulated surface is complete once all input points have been inserted and define vertices of triangles within the surface. Figure 4-28 shows the completed triangulation for a set of thirty input points (but omits the bounding triangles). Figure 4-29 shows the *convex hull* (convex polygon that bounds the set of input points) of the thirty input points shown in Figure 4-28. The algorithm can calculate an interpolated value at any arbitrary location within the convex hull.

The interpolation is a three-point interpolation that uses one of triangulation's triangle's vertices as the three points to use as the basis for the interpolation.

For any arbitrary location within the convex hull, the algorithm first determines the triangle that encloses the arbitrary location and then performs a three-point interpolation using the enclosing triangle and its associated acoustics values. Locations outside of the convex hull produce an indeterminate value. The following equation summarizes the interpolation for an arbitrary point:

$$p_z = p_{1z} + \frac{(a(p_{1x} - p_x) + b(p_{1y} - p_y))}{c} \quad \text{Eq. 4-114}$$

where

$p$	Arbitrary point for which interpolated value is determined;
$p_x$	x-coordinate of point $p$ ;
$p_y$	y-coordinate of point $p$ ;
$p_z$	Calculated interpolated value of point $p$ ;
$p_1$	Point 1 (vertex of triangle) ;
$p_{1x}$	x-coordinate of Point 1;

---

$p_{1y}$	y-coordinate of Point 1;
$p_{1z}$	Acoustics value associated with Point 1;
$p_2$	Point 2 (vertex of triangle) ;
$p_{2x}$	x-coordinate of Point 2;
$p_{2y}$	y-coordinate of Point 2;
$p_{2z}$	Acoustics value associated with Point 2;
$p_3$	Point 3 (vertex of triangle) ;
$p_{3x}$	x-coordinate of Point 3;
$p_{3y}$	y-coordinate of Point 3;
$p_{3z}$	Acoustics value associated with Point 3;
$a$	$(p_{2y} - p_{1y})(p_{3z} - p_{1z}) - (p_{3y} - p_{1y})(p_{2z} - p_{1z});$
$b$	$-(p_{2x} - p_{1x})(p_{3z} - p_{1z}) + (p_{3x} - p_{1x})(p_{2z} - p_{1z});$ and
$c$	$(p_{2x} - p_{1x})(p_{3y} - p_{1y}) - (p_{3x} - p_{1x})(p_{2y} - p_{1y}).$

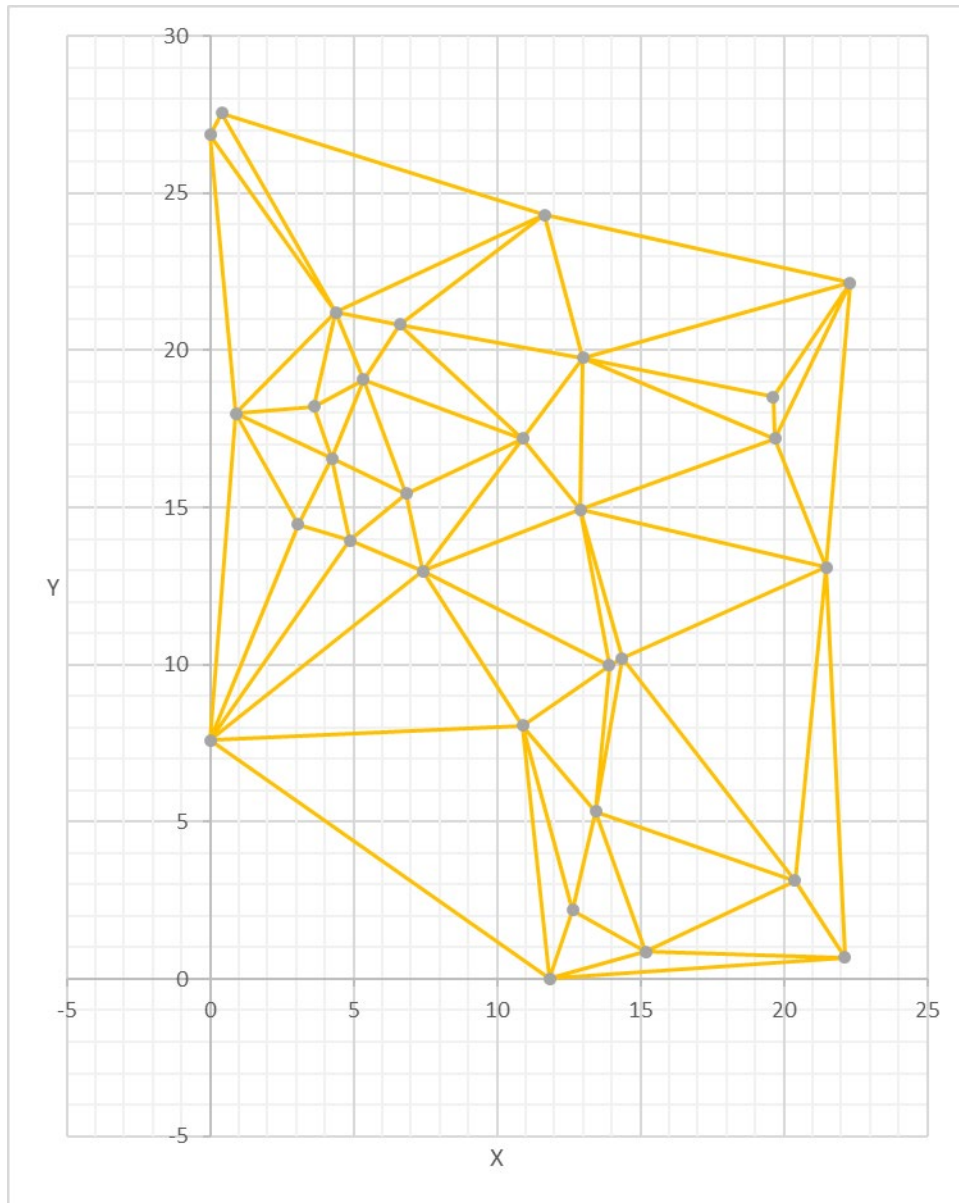

Figure 4-28 A Delaunay triangulation of a set of thirty points. The three bounding triangle vertices and all bounding triangles have been omitted from the diagram.



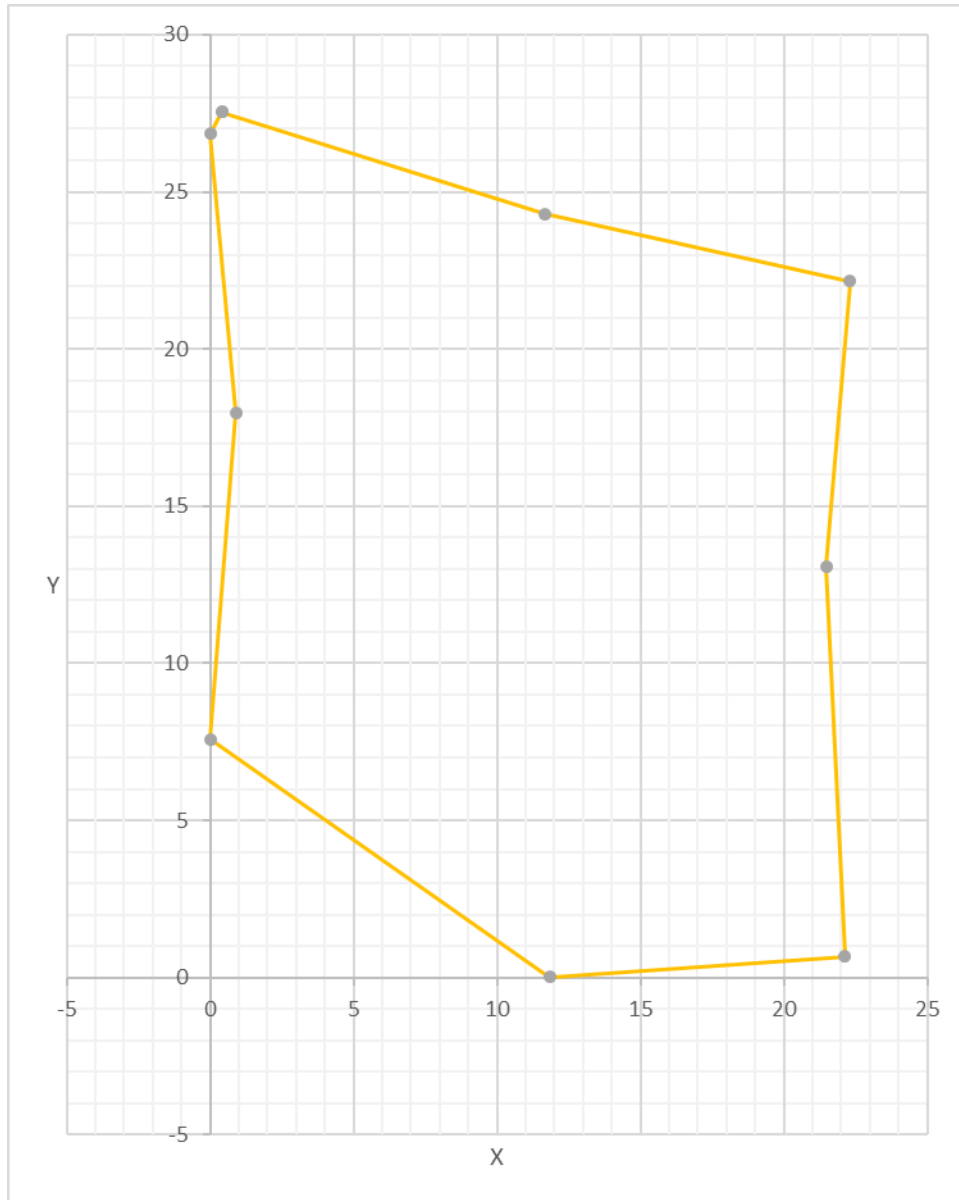

Figure 4-29 The convex hull of the triangulation presented in Figure 4-28. An interpolated value can be determined anywhere within the convex hull. The interpolation is a three-point interpolation based on the acoustics values associated with the vertices of the triangle that encloses the arbitrary location.

#### 4.8.7 Combination

The acoustics combination algorithm combines two acoustics metric results at-a-time. When a user selects more than two acoustics results to combine, the algorithm combines the first two acoustics results. This combined acoustics result is then combined with the third and so on.

The input point sets shown in Figure 4-28 and Figure 4-30 will be used to describe the acoustics combination algorithm. Figure 4-30 is a Delaunay triangulation of a distinct set of thirty points from those presented in Figure 4-28. Figure 4-31 shows the convex hull of the triangulation presented in Figure 4-30.

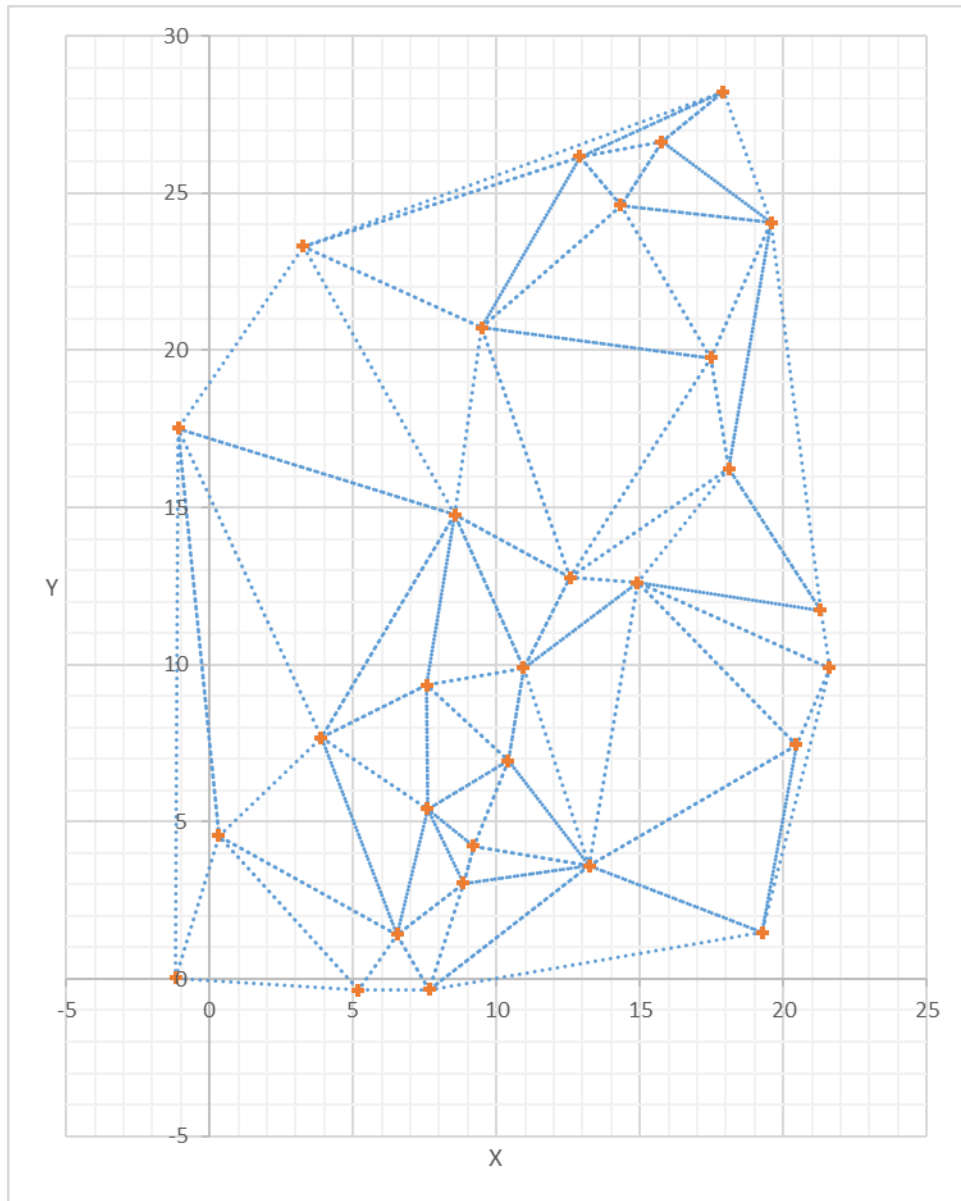

Figure 4-30 A Delaunay triangulation of a set of thirty points. The input points are at different locations than those presented in Figure 4-28. The three bounding triangle vertices and all bounding triangles have been omitted from the diagram.

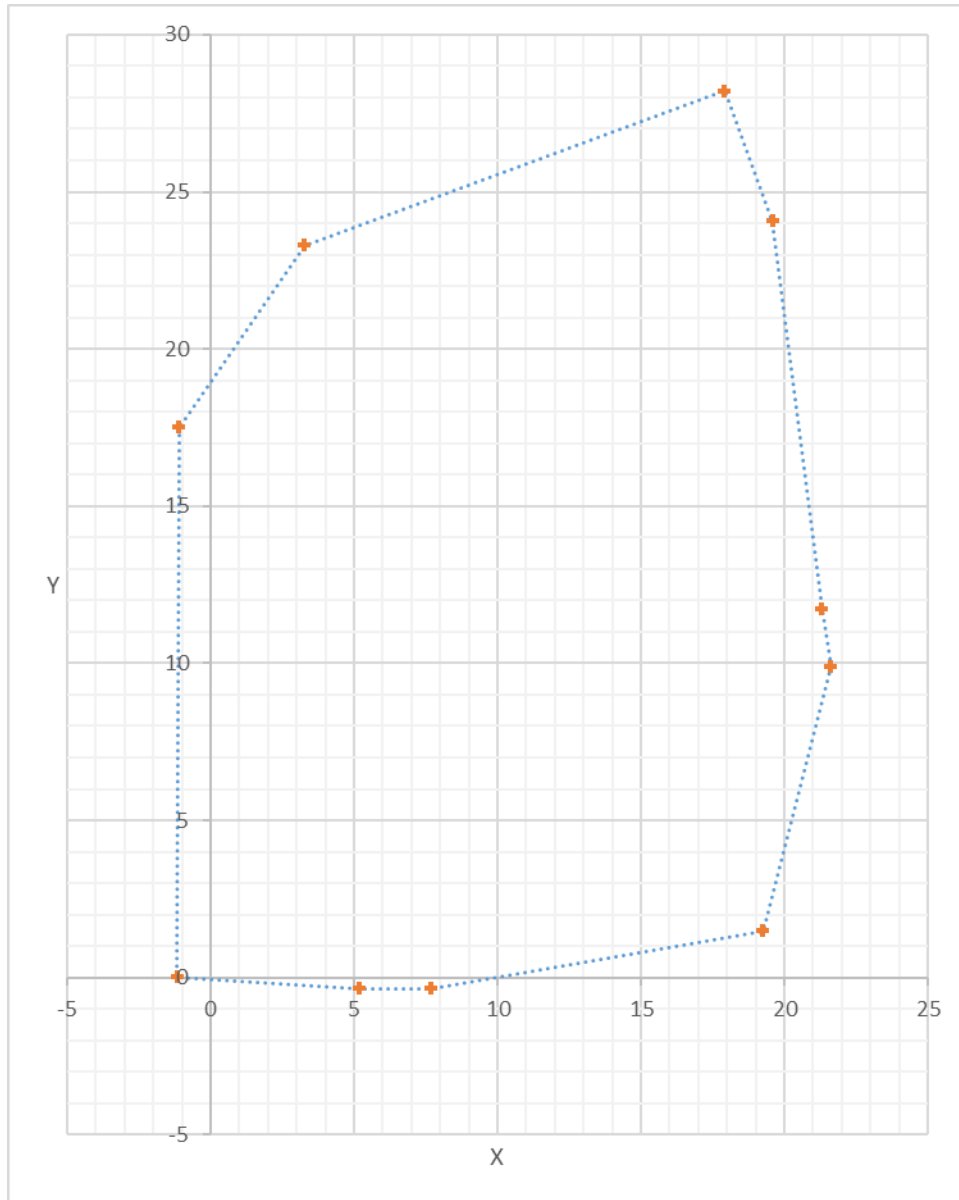

Figure 4-31 The convex hull of the triangulation presented in Figure 4-30. An interpolated value can be determined anywhere within the convex hull. The interpolation is a three-point interpolation based on the acoustics values associated with the vertices of the triangle that encloses the arbitrary location

If the input point set from Figure 4-28 was selected first, that triangulation would be considered as the base acoustic triangulation (or field) and the input point set from Figure 4-30 would be considered the alternate acoustic triangulation. If the input point set from Figure 4-30 was selected first, that triangulation would be considered the base triangulation while the triangulation from Figure 4-28 would be considered the alternate triangulation. For the figures below, the triangulation associated with Figure 4-28 shall be considered as the base triangulation while the triangulation associated with Figure 4-30 shall be considered the alternative triangulation.

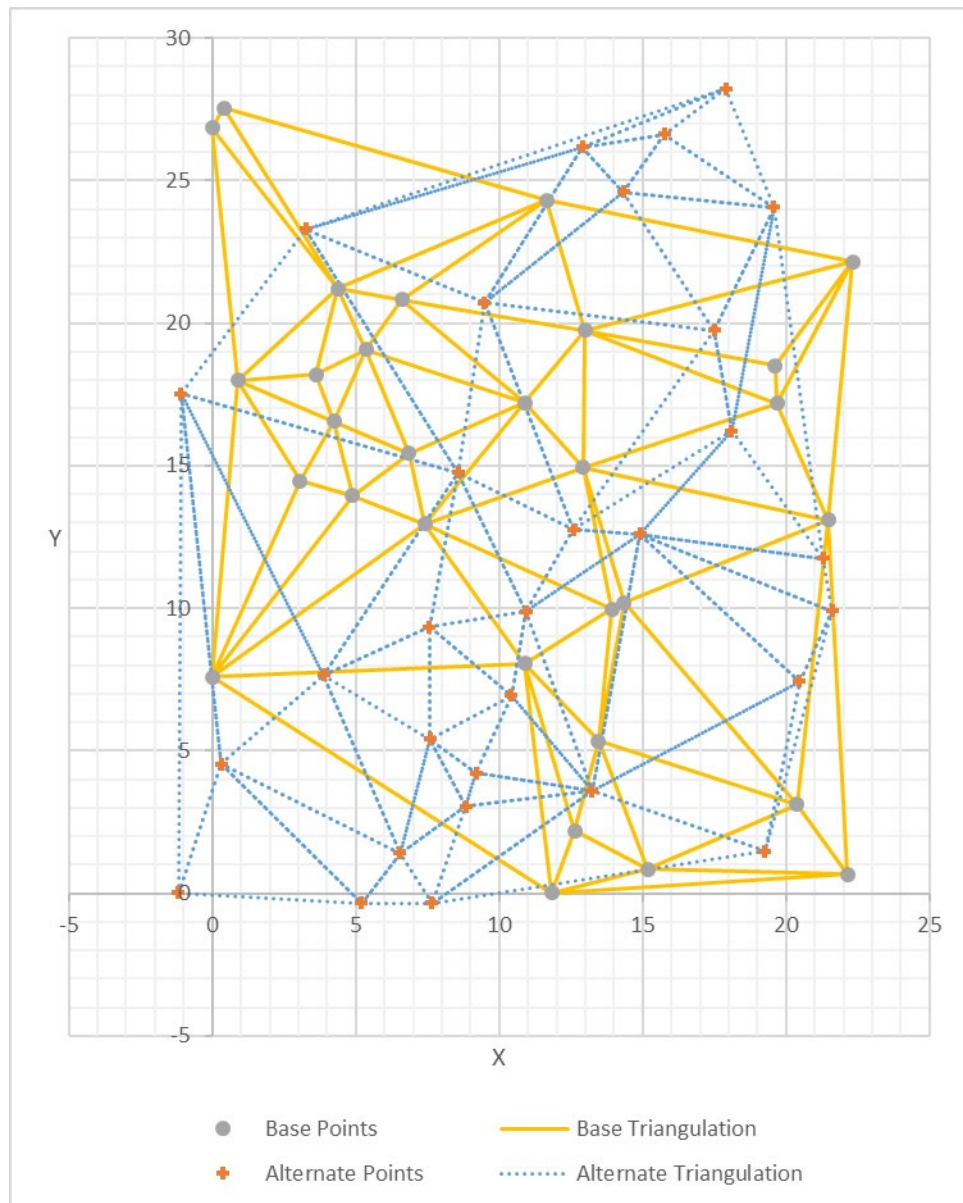

Figure 4-32 Triangulations associated with Figure 4-28 and Figure 4-30 overlaid. In this diagram, the Figure 4-28 triangulation is considered the base field while the Figure 4-30 triangulation is considered the alternate field.

Using Figure 4-33 as a reference, the combination algorithm will generate a combined point set that consists of the following:

- All base points that are within the convex hull of the alternate points shall have their associated acoustics value **combined** (the exact manner of combination depends on the metric type) with the interpolated acoustics value at their respective location in the alternate field.

- All base points that are outside the convex hull of the alternate points shall not be combined with a value since an interpolated value cannot be determined in the alternate field.
- All alternate points that are within the convex hull of the base points shall have their associated acoustics value **combined** with the interpolated acoustics value at their respective location in the base field.
- All alternate points that are outside the convex hull of the base points shall not be combined with a value since an interpolated value cannot be determined in the base field.

The following three subsection describe the manner that is used to combine two acoustics values and two options that govern the output points that are generated by two combined sets of input points.

#### 4.8.7.1 *Combination Mode*

The mode of acoustics combination is selected by the algorithm and depends entirely on the metric type of the acoustics being combined.

##### Exposure-Based Metrics

$$p_z = 10 \log_{10} \left( 10^{\left(\frac{p_{1z}}{10}\right)} + 10^{\left(\frac{p_{2z}}{10}\right)} \right) \quad \text{Eq. 4-115}$$

where

$p_z$	Combined acoustics value (dB);
$p_{1z}$	Acoustics value of the base point (dB); and
$p_{2z}$	Acoustics value of the alternate point (dB).

##### Maximum-Level Metrics

$$p_z = \max(p_{1z}, p_{2z}) \quad \text{Eq. 4-116}$$

where

$p_z$	Combined acoustics value (dB);
$p_{1z}$	Acoustics value of the base point (dB); and
$p_{2z}$	Acoustics value of the alternate point (dB).

##### Time-Above Metrics

$$p_z = p_{1z} + p_{2z} \quad \text{Eq. 4-117}$$

where

$p_z$	Combined acoustics value (minutes);
$p_{1z}$	Acoustics value of the base point (minutes); and

$p_{2z}$  Acoustics value of the alternate point (minutes).

### **Number-Above Metrics**

$$p_z = p_{1z} + p_{2z} \quad \text{Eq. 4-118}$$

where

$p_z$  Combined acoustics value (number);  
 $p_{1z}$  Acoustics value of the base point (number); and  
 $p_{2z}$  Acoustics value of the alternate point (number).

#### ***4.8.7.2 Combination Selection***

The two combination options are the following:

##### **Union**

All base points and alternate points appear in the combined (i.e., the output) receptor set.

##### **Intersection**

Only the base points that are within the convex hull of the alternate field and only the alternate points that are within the convex hull of the base field appear in the combined receptor set.

#### ***4.8.7.3 Receptor Exclusion Distance***

The receptor exclusion distance determines which alternate field receptors are excluded from the combined receptor set. All alternate receptors that are within the exclusion distance of any base receptors will not appear in the combined receptor set.

It should be noted that even though a combined receptor set may exclude receptors from the alternate input receptor set, the acoustics values of the alternate receptor set were used in the combination algorithm even though their locations do not appear in the output receptor set.

## 5. Emissions Inventory

### 5.1 Aircraft Emissions

AEDT computes emissions related to aircraft operations including emissions from taxi, startup, and APU. It also computes emissions from runup operations that occur at the airport's surface (0 ft AFE) and involve some or all of the aircraft's engines. The following pollutants are modeled gate-to-gate based on phases of flight:

- Carbon Monoxide (CO),
- Total Hydrocarbons (THC),
- Non-Methane Hydrocarbons (NMHC),
- Volatile Organic Compounds (VOC),
- Total Organic Gases (TOG),
- Nitrogen Oxides (NO<sub>x</sub>),
- Sulfur Oxides (SO<sub>x</sub>),
- Particulate Matter (PM),
- Carbon Dioxide (CO<sub>2</sub>),
- Water (H<sub>2</sub>O),
- Carbon dioxide equivalent (CO<sub>2</sub>e), and
- Speciated Organic Gases (SOG), including hazardous air pollutants (HAPs).

#### 5.1.1 Airborne Emissions

There are two broad flight regimes in AEDT: terminal area and en-route. The term "terminal area" refers to portions of an aircraft's flight trajectory below 10,000 ft AFE, while the term "en-route" refers to portions of flight above 10,000 ft AFE. A runway-to-runway flight path covers both terminal area and en-route regimes. AEDT assigns the trajectory mode on each segment of the flight trajectory across both flight regimes. The terminal area trajectory modes in AEDT include takeoff ground roll, takeoff airborne, terminal climb, approach, landing ground roll, and landing ground roll with reverse thrust. En-route trajectory modes include enroute climb, cruise, and enroute descent.

The methods used to compute airborne aircraft emissions in AEDT are described below:

- The Boeing Fuel Flow Method 2 (BFFM2)<sup>37</sup> is used to compute NO<sub>x</sub>, THC, and CO;
- The nvPM Mission Emissions Estimation Methodology (MEEM) (Ahrens et al.<sup>38</sup>) is used to estimate full flight emissions for nvPM mass and nvPM number:
  - For engines with measured non-volatile particulate matter (nvPM) data in the ICAO Emissions Data Bank, measured EIs are used to calculate nvPM mass and particle number;
  - First Order Approximation (FOA) 4.0<sup>40</sup> is used to compute nvPM (for engines without measured EI data) mass and number below the mixing height;
  - Above the mixing height, nvPM mass and number are estimated using the steps detailed in MEEM and are based on either the measured data, or when measured data are not available, EIs calculated from smoke number using steps in FOA 4.0;
  - When no measured nvPM data or smoke number data are available, no nvPM emissions are reported;
- FOA 4.0 is used to compute volatile and total particulate matter mass and number below the mixing height;

- Volatile particulate matter mass is estimated above the mixing height using static emission factors (0.036 g/kg-fuel for vPM mass from sulfates and 0.03 g/kg-fuel for vPM mass from fuel organics);
- Fuel composition-based factors are used to compute SO<sub>x</sub>, CO<sub>2</sub>, and H<sub>2</sub>O in addition to particulate matter above the mixing height; and
- Derivative factors are used to compute NMHC, VOC, TOG, and speciated organic gases.

These methods are publicly available and internationally recognized as adequate for aircraft emissions modeling. For emissions inventory, users can change the default value of 3,000 ft AFE for the mixing height in AEDT. For emissions dispersion, the mixing height varies by hour as modeled by AERMET. While AEDT calculates emissions in the terminal area up to 10,000 ft, only emissions up to 3,000 ft AFE are considered for emissions dispersion..

When nvPM mass and particle number cannot be calculated because of missing data, the values are reported as N/A in the Emissions Inventory Report and are populated as NULL in the RSLT\_EMISSIONS\_SEGMENT table.

#### 5.1.1.1 Boeing Fuel Flow Method 2

Of the four methods employed within AEDT, the most complex is the BFFM2. This method requires various atmospheric parameters including engine emissions certification-type data and fuel flow/fuel burn at flight conditions. Since this method relies on fuel flow as a direct input rather than power settings, it is called a “fuel flow method.” The BFFM2<sup>37</sup> documentation also provides guidance for anomalous cases, e.g., when certification data do not behave according to the prescribed methodology.

BFFM2 is currently only used to model NO<sub>x</sub>, THC, and CO because these are the only pollutants (in addition to particulates) for which data are available in the ICAO jet engine emissions certification databank (EEDB)<sup>12</sup>. Similarly, the emissions database within AEDT relies on data derived for the EDMS<sup>39</sup>. These data are a superset of the ICAO EEDB, primarily due to the addition of data for turboprop and piston engines, as well as engines associated with more recent aircraft (e.g., Airbus A380). Generally these additional data are provided directly from manufacturers; the AEDT Fleet database provides a complete record of these engine data and their origins. For each engine listed, the Fleet database contains an inventory of emissions produced per fuel consumed (henceforth referred to as an emission index (EI)) and fuel flow values corresponding to the standard landing-and-takeoff (LTO) cycle modes. The four standard modes are takeoff, climbout, approach, and idle which correspond to power settings of 100%, 85%, 30%, and 7%, respectively.

The steps in the BFFM2 Model as used in AEDT are detailed below:

1. The four ICAO reference fuel flows are adjusted for installation effects, that is, each of these fuel flows is multiplied by a modal-specific adjustment factor defined in BFFM2. These adjustment factors are shown in the table below.



Table 5-1 Adjustment Factors for Installation Effects

Mode	Power Setting (%)	Adjustment Factor
Takeoff	100	1.010
Climb-out	85	1.013
Approach	30	1.020
Idle	7	1.100

2. Using the adjusted fuel flows from step 1 and the reference EI (REI) values from the Fleet database, Log-Log relationships between EI and fuel flow values are developed that allow predictions of reference EI values for reference fuel flow values. For NO<sub>x</sub>, a point-to-point relationship is developed. For THC and CO, a bilinear fit is established between the two lower power setting points and the two higher power setting points. For fuel flow values outside the range specified by the modes given in Table 5-1 (above takeoff or below idle) AEDT does the following:
  - a. For adjusted fuel flow values above takeoff: fuel flow values are kept, but all corresponding reference emission index values are capped to equal that of takeoff.
  - b. For adjusted fuel flow values below idle: fuel flow values are changed to equal that of idle, and all corresponding reference emission index values are also capped to equal that of idle.
3. A non-reference fuel flow value is determined within AEDT. The fuel flow corresponds to at-altitude (MSL) atmospheric conditions for a specific flight segment or mode.
4. The non-reference fuel flow from step 3 is converted to reference conditions using the following equation:

$$RWf = \frac{Wf}{\delta} \theta^{3.8} e^{0.2M^2} \quad \text{Eq. 5-1}$$

where

- RWf Fuel flow at reference conditions (kg/s);
- Wf Fuel flow at non-reference conditions (kg/s);
- M Mach number;
- θ Static Temperature ratio (ambient to sea level); and
- δ Static Pressure ratio (ambient to sea level).

5. Using the Log-Log relationships from step 2 and the reference fuel flow from step 4, reference EI values for NO<sub>x</sub>, THC, and CO are obtained.
6. The reference EI values from step 5 are converted to non-reference (at MSL altitude) conditions using the following equations:

$$NO_x EI = NO_x REI e^H \left[ \frac{\delta^{1.02}}{\theta^{3.3}} \right]^{1/2} \quad \text{Eq. 5-2}$$

$$THCEI = THCREI \frac{\theta^{3.3}}{\delta^{1.02}} \quad \text{Eq. 5-3}$$

$$COEI = COREI \frac{\theta^{3.3}}{\delta^{1.02}} \quad \text{Eq. 5-4}$$

$$H = -19.0 \left[ \frac{0.62197058 \phi P_v}{P - \phi P_v} - (6.34 \times 10^{-3}) \right] \quad \text{Eq. 5-5}$$

where

NOx EI	NOx EI at non-reference conditions (g/kg);
NOx REI	NOx EI at reference conditions (g/kg);
THCEI	THC EI at non-reference conditions (g/kg);
THCREI	THC EI at reference conditions (g/kg);
COEI	CO EI at non-reference conditions (g/kg);
COREI	CO EI at reference conditions (g/kg);
M	Mach number;
$\theta$	Static Temperature ratio (ambient to sea level);
$\delta$	Static Pressure ratio (ambient to sea level);
H	Humidity coefficient;
$\phi$	Relative humidity;
P	Inlet ambient pressure (millibars); and
$P_v$	Saturation vapor pressure (millibars). Refer to Eq. 5-6.

where

$$P_v = (6.107)10^{\left(\frac{aT}{b+T}\right)} \quad \text{Eq. 5-6}$$

T	Temperature in degrees Celsius;
a	7.5; and
b	237.3.

- The non-reference fuel burn corresponding to the fuel flow in step 3 is obtained.
- Using the non-reference EI values from step 6 and the non-reference fuel burn from step 7, the non-reference emissions of NO<sub>x</sub>, THC, and CO are computed. These represent the final emissions for the flight segment.

### 5.1.1.2 Measured EIs and Non-Volatile Particulate Matter Below the Mixing Height

For engines with measured nvPM EI data in the ICAO Emissions Databank, the measured EI values are used to calculate nvPM mass and particle number.

nvPM mass below the mixing height is calculated according to this equation for engines with Measured EI data in the ICAO Emissions Data Bank.

$$nvPM_{Mass} = \text{Segment Fuel Burn} * EI_{mass} \quad \text{Eq. 5-7}$$

Where  $nvPM_{Mass}$  is the mass of nvPM in grams, Segment Fuel Burn is the segment total fuel burned across all engines in kilograms and  $EI_{Mass}$  is the segment emissions mode specific value from the ICAO EEDB<sup>12</sup> for the engine in grams per kilogram of fuel burned, incorporating system loss. The segment

emissions modes are climbout, takeoff, idle and approach as assigned by the Aircraft Performance Module (APM) to the segment.

nvPM number below the mixing height is calculated according to this equation for engines with measured EI data in the ICAO Emissions Data Bank.

$$nvPM_{Number} = \text{Segment Fuel Burn} * EI_{Number} \quad \text{Eq. 5-8}$$

Where  $nvPM_{Number}$  is the particle number of nvPM, Segment Fuel Burn is the segment total fuel burned across all engines in kilograms and  $EI_{Number}$  is the segment emissions mode specific nvPM particle number per kilogram of fuel burned, incorporating system loss. The segment emissions modes are climbout, takeoff, idle and approach as assigned by the APM to the segment.

#### 5.1.1.3 First Order Approximation 4.0 Method

AEDT uses the First Order Approximation 4.0 (FOA 4.0) methodology to calculate volatile PM and non-volatile PM when measured EI data is not available.

- AEDT applies the FOA 4.0 method for all volatile PM calculations at and below the mixing height.
- AEDT applies the FOA 4.0 method for all non-volatile PM calculations, regardless of altitude.

For details on FOA 4.0, please refer to the Update of ICAO's Airport Air Quality Manual (Doc 9889)<sup>40</sup>.

#### 5.1.1.4 Constant PM EI Values for Volatile PM Above the Mixing Height Method

When the FOA 4.0 method cannot be applied due to a lack of available data, the static cruise PM coefficients in Table 5-2 are used for all volatile PM calculations above the mixing height.

For all PM calculations above the mixing height, constant EI values across all aircraft and engine types are employed for sulfur and fuel organics. The default EI values<sup>1</sup> are stored in the PM\_EI table of the Study database and are shown in Table 5-2. These values can be modified by the user using database tools.

Table 5-2 Default Constant PM EI Values above the Mixing Height

PM Species	EI (g/kg-fuel)
Sulfur	0.036
Fuel Organic	0.03

#### 5.1.1.5 Non-Volatile Particulate Matter Modeling Above the Mixing Height

MEEM provides steps for estimating nvPM mass and nvPM particle number above the mixing height using measured nvPM EI data available in the ICAO EEDB, with system loss corrections applied, or using nvPM EIs derived from smoke number using the steps detailed in FOA 4.0 when measured data is not available. Engines with measured nvPM EI data provide EIs for the four LTO points, with the option for manufacturers to provide a voluntary fifth point, the peak nvPM EI. The same steps are used in MEEM to estimate nvPM mass and number given measured EI data at the four LTO points or EIs derived from smoke number at the four LTO points. When the measured, peak EI is provided, the methodology is

altered to include the peak EI as a fifth interpolation point. Peak EIs are provided in the EEDB without system loss corrections and are stated as occurring between two of the adjacent LTO power settings. System loss corrected Peak nvPM EIs are derived from uncorrected peak nvPM EIs from the ICAO EEDB and stored in the AEDT Fleet database. The peak power setting is taken as the midpoint of the adjacent power settings and the system loss corrected peak EIs are determined by linear interpolation using the uncorrected peak EI values, the uncorrected EI values at the adjacent power settings, and system loss corrected EI values at the adjacent power settings. It is recommended not to extrapolate below 7% or above 100% thrust, but rather limit the peak EI values at 7 and 100%, respectively.

The steps for estimating nvPM Mass and particle number above the mixing height are further detailed in Ahrens et al.<sup>38</sup> and are summarized below:

- Step 0: EIs for nvPM mass and nvPM number are calculated using FOA 4.0, only if smoke number is available and measured EI data is not available in ICAO EEDB.
- Step 1: Temperature and pressure are estimated outside of the engine and in the combustion chamber at the aircraft's altitude AFE.
- Step 2: Temperature, pressure, combustor inlet pressure, and engine power are estimated at the ground reference point, which is taken in AEDT to be sea-level ISA conditions.
- Step 3: The nvPM EIs at ground reference conditions are determined by the four point method – linear interpolation between the four LTO points, or the five point method – linear interpolation between the four LTO points and the peak point, when peak EI data is available. In AEDT, the thrust setting of the peak EI is taken as the midpoint of the two LTO thrust settings adjacent to the peak EI.
- Step 4: Transposition of the nvPM EI at ground conditions to nvPM EIs at altitude AFE and calculation of nvPM mass and nvPM particle number using AEDT calculated fuel flow.

#### 5.1.1.6 Sulfur Approximation

Sulfur which does not convert to the sulfur component of PM (sulfate) is assumed to convert into SO<sub>x</sub>. Therefore, the SO<sub>x</sub> EI approximation will use the FSC and conversion efficiency, and outlined in FOA 4.0. Refer to the equation D-8 in the Doc 9889<sup>40</sup> for the SO<sub>x</sub> calculation process.

#### 5.1.1.7 CO<sub>2</sub> and H<sub>2</sub>O Approximations

Emissions of CO<sub>2</sub> and H<sub>2</sub>O are modeled based on Jet Fuel A composition. Boeing conducted a review of the available fuel composition data and developed EI values that could be used to predict emissions solely based on fuel burn<sup>41,42</sup>. These value are used The values are shown in Table 5-3.

Table 5-3 Constant CO<sub>2</sub> and H<sub>2</sub>O EI Values

Pollutant	EI (g/kg)
CO <sub>2</sub>	3,155
H <sub>2</sub> O	1,237

Since these EI values were derived based on average fuel compositions, they are constants used for all modes and all atmospheric conditions. The CO<sub>2</sub> EI is used for all aircraft sources including APUs. Alternative values for the CO<sub>2</sub> and H<sub>2</sub>O EI values may be provided as input, replacing the values presented in Table 5-3.

#### 5.1.1.8 Derivative Factors for Modeling VOC, NMHC, and TOG

Three pollutants, VOC, NMHC, and TOG, are calculated by applying various factors to the THC amount (THC being calculated from the BFFM2 methodology noted above)<sup>43, 44</sup>. The factors used to calculate VOC, NMHC, and TOG are known as derivative factors. AEDT applies the derivative factors based on the engine type (turbine, piston).

The THC calculated in the BFFM2 is presented in terms of methane equivalency. TOG and NMHC are presented in terms of their own mass (TOG as TOG and NMHC as NMHC, respectively). For turbine engines, a derivative factor ( $TOG_{ConversionFactor}$ ) is applied to the calculated THC to compute TOG. NMHC is computed by applying a conversion factor ( $NMHC_{ConversionFactor}$ ) to the mass of TOG. And finally, VOC is computed by subtracting the mass of ethane from TOG. Therefore, to obtain VOC in terms of its own mass (VOC as VOC), TOG is multiplied by  $(1 - \text{the mass fraction of ethane in TOG})$ . For the sake of simplicity, AEDT uses a derivative factor ( $VOC_{ConversionFactor}$ ) to convert TOG to VOC. The application of the derivative factors to calculate TOG, NMHC, and VOC for turbine engines is demonstrated in Figure 5-1 and Eq. 5-9 through Eq. 5-11.

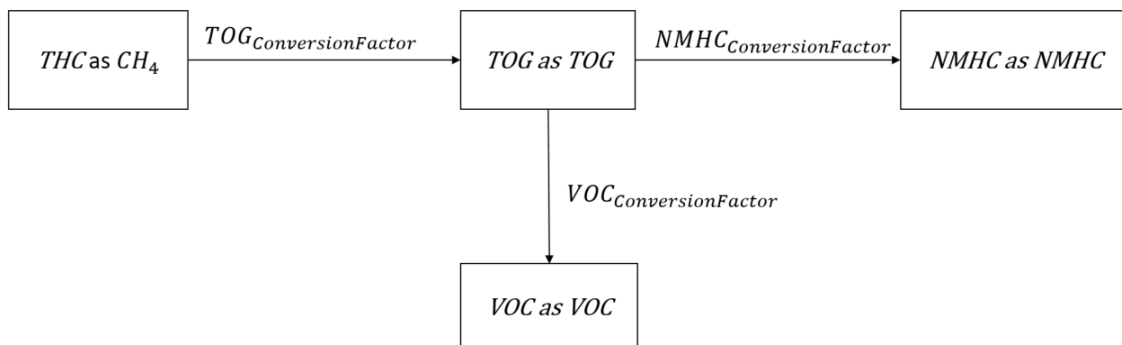

Figure 5-1 TOG, NMHC, and VOC Calculations for Turbine Engines

The equations for TOG, NMHC, and VOC for turbine engines are below:

$$TOG_{TOG} = THC_{CH_4} \cdot TOG_{ConversionFactor} \quad \text{Eq. 5-9}$$

$$NMHC_{NMHC} = TOG_{TOG} \cdot NMHC_{ConversionFactor} \quad \text{Eq. 5-10}$$

$$VOC_{VOC} = TOG_{TOG} \cdot VOC_{ConversionFactor} \quad \text{Eq. 5-11}$$

where

$TOG_{TOG}$	TOG emissions as TOG (g);
$THC_{CH4}$	THC emissions using BFFM2 (in terms of methane equivalency) (g);
$NMHC_{NMHC}$	NMHC emissions as NMHC (g); and
$VOC_{VOC}$	VOC emissions as VOC (g).

$TOG_{ConversionFactor}$ ,  $VOC_{ConversionFactor}$ , and  $NMHC_{ConversionFactor}$  are all inputs used to compute TOG, VOC, and NMHC emissions respectively. Table 5-4 lists the default conversion factors for aircraft with turbine engines.

Table 5-4 Pollutant Conversion Factors for Turbine Engines

Conversion Factor	Default Value
$TOG_{ConversionFactor}$	$1,156,234.049 \times 10^{-6}$
$VOC_{ConversionFactor}$	$9,947.855 \times 10^{-4}$
$NMHC_{ConversionFactor}$	1.000

The default  $9,947.855 \times 10^{-4}$  value for  $VOC_{ConversionFactor}$ , assumes a  $52.145 \times 10^{-4}$  value for the ethane content in TOG. The default 1.000 value for  $NMHC_{ConversionFactor}$ , assumes that no methane is produced; therefore, NMHC is equal to TOG.

For piston aircraft, TOG, NMHC, and VOC calculations differ from the calculations done for aircraft with turbine engines. As for turbine engines, derivative factors are applied to the computed mass of HC in methane equivalency. However, a derivative factor ( $VOC_{ConversionFactor}$ ) is multiplied by HC to calculate VOC as VOC. Next, a derivative factor ( $TOG_{ConversionFactor}$ ) is multiplied by VOC as VOC to calculate TOG as TOG. And finally, for piston engines, methane may be present in TOG; therefore, there is a third derivative factor ( $NMHC_{ConversionFactor}$ ), which is multiplied by TOG as TOG to calculate NMHC as NMHC. The application of the derivative factors to calculate TOG, NMHC, and VOC for piston engines is demonstrated in Figure 5-2 and Eq. 5-12 through Eq. 5-14.

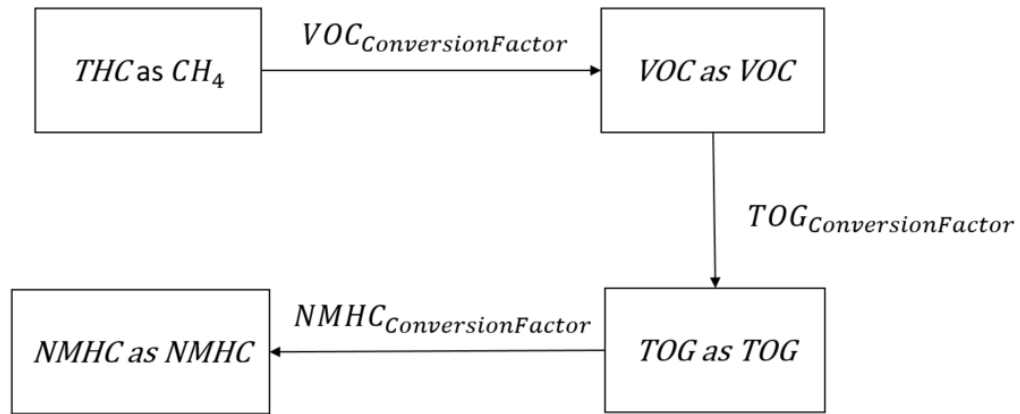

Figure 5-2 TOG, NMHC, and VOC Calculations for Piston Engines

Additionally, the equations for TOG, NMHC, and VOC (for piston engines) are below:

$$TOG_{TOG} = VOC_{VOC} \cdot TOG_{ConversionFactor} \tag{Eq. 5-12}$$

$$NMHC_{NMHC} = TOG_{TOG} \cdot NMHC_{ConversionFactor} \tag{Eq. 5-13}$$

$$VOC_{VOC} = THC_{CH_4} \cdot VOC_{ConversionFactor} \tag{Eq. 5-14}$$

where

- TOG<sub>TOG</sub> TOG emissions as TOG (g);
- THC<sub>CH<sub>4</sub></sub> THC emissions using BFFM2 (in terms of methane equivalency) (g);
- NMHC<sub>NMHC</sub> NMHC emissions as NMHC (g); and
- VOC<sub>VOC</sub> VOC emissions as VOC (g).

TOG<sub>ConversionFactor</sub>, VOC<sub>ConversionFactor</sub>, and NMHC<sub>ConversionFactor</sub> are all inputs used to compute TOG, VOC, and NMHC emissions respectively. Table 5-5 lists the default conversion factors for aircraft with piston engines.

Table 5-5 Pollutant Conversion Factors for Piston Engines

Conversion Factor	Default Value
TOG <sub>ConversionFactor</sub>	117.371 x 10 <sup>-2</sup>
VOC <sub>ConversionFactor</sub>	83.471 x 10 <sup>-2</sup>
NMHC <sub>ConversionFactor</sub>	8.905 x 10 <sup>-1</sup>

### 5.1.1.9 Derivative Factors for Speciated Organic Gases

The total mass for each speciated organic gas is computed by multiplying its mass fraction to the  $TOG_{TOG}$  emissions. Once the  $TOG_{TOG}$  amount is calculated (from Eq. 5-9 or Eq. 5-12 above), the mass for every speciated organic gas component in its own mass is computed by multiplying its respective mass fraction by the TOG amount, as in Eq. 5-15.

$$SOG_i = TOG_{TOG} \cdot MF_i \quad \text{Eq. 5-15}$$

where

$SOG_i$	Speciated organic gas emissions (g);
$TOG_{TOG}$	TOG emissions as TOG (g); and
$MF_i$	Mass fraction of speciated organic gas.

Mass Fraction of speciated organic gas is defined by three tables, STN\_SPEC\_PROF, STN\_MASS\_FRAC, and STN\_SPEC\_HC. The STN\_SPEC\_PROF table defines the speciation profile. For airborne emissions, profiles are either turbine or piston. The STN\_MASS\_FRAC table defines the mass fractions of pollutants for a given profile. The STN\_SPEC\_HC table defines pollutant IDs for specific organic gas pollutants.

### 5.1.2 Taxi Emissions

This section outlines the process AEDT follows to compute the emissions from taxi. When the taxi trajectory modeling option (“Apply Delay & Sequencing Model”) is selected, AEDT does not compute the emissions from taxi times-in-mode (i.e., flight-based taxi times or airport layout taxi times), regardless of whether taxi time-in-mode data exists to do so. Taxi trajectory modeling is mutually exclusive with taxi time-in-mode modeling.

1. If the “Apply Delay & Sequencing Model” option is not selected,
  - a) And if the “Enable flight-based taxi times” preference is selected, Retrieve the taxi time for aircraft operation.
  - b) And if the “Enable flight-based taxi times” preference is not selected, Retrieve the taxi time for the airport layout.
2. If the “Apply Delay & Sequencing Model” option is selected,
  - a) Taxi time is equal to the sum of the durations of each individual taxi trajectory segment
3. Retrieve the emissions index values for the aircraft’s engine.
4. If the “Enable engine multiplier for flight-based taxi times” option (in the Emissions Preferences screen) is selected,
  - a) All engines from each airframe are used for taxi emissions.
5. If the “Enable engine multiplier for flight-based taxi times” is not selected,
  - a) A single engine from each airframe is used for taxi emissions.
6. Set the following emissions input parameters:
  - a) Convert the airport humidity from percent to a fraction.
  - b) Set the sulfur conversion and sulfur content values:
    - Set Sulfur Conversion to user-specified *Sulfur to sulfate conversion rate*.
    - Set Sulfur Content to user-specified *Fuel sulfur content*.
  - c) If the aircraft uses a piston engine,
    - Set NMHC Conversion Factor =  $8.905 \times 10^{-1}$



- Set TOG Conversion Factor =  $117.371 \times 10^{-2}$
  - Set VOC Conversion Factor =  $83.471 \times 10^{-2}$
  - Set Speciated THC Mass Ratios to the SOG mass fractions for piston engines.
  - Set Speciated THC Count to the number of the SOG mass fractions for piston engines.
- d) If the aircraft use a turbine engine,
- Set NMHC Conversion Factor = 1.0
  - Set TOG Conversion Factor =  $1,156,234.049 \times 10^{-6}$
  - Set VOC Conversion Factor =  $9,947.855 \times 10^{-4}$
  - Set Speciated THC Mass Ratios to the SOG mass fractions for turbine engines
  - Set Speciated THC Count to the number of the SOG mass fractions for turbine engines.
7. For each taxi segment, calculate the fuel flow, fuel burn, and emissions.
8. Set the pressure, delta, temperature, and theta values to be equal to those from the retrieved flight path segment.
9. Set the fuel flow using the following equation.
- a) If the “Apply Delay & Sequencing Model” option is selected,

$$Fuel\ Flow = (1.1)(0.73)W_{ID}\delta\theta^{-3.8} \quad \text{Eq. 5-16}$$

where

- $W_{ID}$  The unadjusted fuel flow for the given aircraft’s engines for idle mode;
- $\delta$  Static Pressure ratio (ambient to sea level); and
- $\theta$  Static Temperature ratio (ambient to sea level).

- b) If the “Apply Delay & Sequencing Model” option is not selected:

$$Fuel\ Flow = (1.1)(0.73)W_{ID} \quad \text{Eq. 5-17}$$

10. Set fuel burn = (fuel flow)(t)(N) where t is the taxi time in seconds and N is the actual number of operating engines on the aircraft.
11. Set Mach number = 0.
12. Set the current mode to idle mode.
13. If the aircraft is user-defined and the smoke number for the current mode is 0 or “N/A”,  
Use the user-specified PM emission index.  
Otherwise use the system PM emissions index.
14. Call the AEM.
15. Store the resulting CO, THC, NMHC, VOC, TOG, NOx, and SOx emissions.
16. Store the resulting PM<sub>10</sub> and PM<sub>2.5</sub> emissions if and only if the aircraft is (a) user-defined; or (b) not user-defined, uses ICAO-certified engines and the applicable smoke number is greater than 0.
17. Store the fuel burn. This is used later to derive CO<sub>2</sub>.
18. Store the resulting speciated organic gases.

### 5.1.3 Startup Emissions

If the operation is a departure, then AEDT models engine startup emissions (if selected by the user) which consist only of the THC, NMHC, VOC and TOG pollutants and consume no fuel. The following outlines the process AEDT follows to compute startup emissions.

1. Use the following equation to compute the aircraft main engine startup emissions per engine<sup>40</sup>, if
  - The aircraft's main engine is ICAO certified; and
  - The engine's thrust rating is larger than 0.
 Else startup emissions measures are set to zero.
2. Multiply the emissions by the total number of engines of the aircraft.
3. Multiply the emissions by the number of departures of the aircraft to obtain the annual aircraft main engine startup emissions.

$$m_{p,e,a} = (0.5)RT_{e,a} + 80 \quad \text{Eq. 5-18}$$

where

- $m_{p,e,a}$  The mass (in grams) of pollutant,  $p$ , emitted in one main engine,  $e$ , startup for aircraft,  $a$ ; and
- $RT_{e,a}$  The rated thrust (in KiloNewtons) of engine,  $e$ , of aircraft,  $a$ .

#### 5.1.4 Auxiliary Power Units Emissions

Eq. 5-19 requires the assigned APU emission factors (in kilograms per hour). The FLT\_APU table stores the emission factors for CO, THC, NO<sub>x</sub>, SO<sub>x</sub>, and PM (both PM<sub>10</sub> and PM<sub>2.5</sub>) for each APU model. User-defined APU and its emissions factors are also stored in the FLT\_APU table. The conversion factor of the equation below for these pollutants is unity (1). For NMHC, VOC, and TOG, the conversion factors of the turbine aircraft engines are used. APU emissions data comes from FAA and EPA documentation<sup>45</sup>. The following equation is used to calculate annual APU emissions.

$$m_{a,p} = \frac{1}{60}LTO_a t_a EF_{a,p} f_{a,p} \quad \text{Eq. 5-19}$$

where

- $m_{a,p}$  The mass (in kilograms) of pollutant,  $p$ , emitted annually from the APU assigned to aircraft,  $a$ ;
- $LTO_a$  The annual number of LTO cycles performed by aircraft,  $a$ ;
- $t_a$  The time (in minutes) the APU assigned to aircraft,  $a$ , operates during each LTO cycle;
- $EF_{a,p}$  The emission factor for pollutant,  $p$ , (in kilograms/hour) for the APU assigned to aircraft,  $a$ ;
- $f_{a,p}$  The conversion factor (unitless) for aircraft,  $a$ , and pollutant,  $p$ ; and
- 60 The number of minutes per hour.

The general approach for calculating greenhouse gases, CO<sub>2</sub>, from APUs is to determine the emissions per unit of time for each individual APU using three distinct parameters:

- (1) the operating time of the APU (total operating time of APUs);
- (2) the fuel flow for each APU (fuel burned per unit of time); and
- (3) an emissions index that converts fuel burned into mass of pollutant generated (mass pollutant generated per mass of fuel burned).

The operating time of each APU is already contained within AEDT, can be edited for each operation as the user sees fit, and can be imported into AEDT when importing aircraft operations via ASIF or CSV.

The fuel flow for each APU is linked to airframe type in Table 5-6, which is sourced from Table 3-A1-6 from the Airport Air Quality Manual, Second Edition.<sup>xxxii</sup> The source table gives the maximum APU fuel flow by aircraft size (maximum seats) and aircraft age. The fuel flow values for the older aircraft were used to populate Table 5-6 below and used to generate fuel flow rates based on the maximum seats parameter of each aircraft.

Table 5-6 Aircraft Size by Maximum APU Fuel Flow Rate

Aircraft Size (Maximum Seats)	Normal Running Maximum Environmental Control System Fuel Flow (kg/h)
Business jets/regional jets (seats < 100)	101
Smaller (100 ≤ seats < 200)	122
Mid-range (200 ≤ seats < 300), all types	164
Larger (300 ≤ seats), older types	202

To connect these fuel flow parameters to the aircraft in AEDT, a parameter for maximum seats has been added to the FLT\_AIRFRAMES table in AEDT. For each airframe with an assigned APU in AEDT, a maximum seats value has been assigned, and will allow for the generation of a fuel flow rate for each APU in AEDT. The maximum seats parameter is editable by the AEDT user, and can be specified for a user-defined airframe.

The CO<sub>2</sub> emission index used is 3,155 grams per kilograms fuel as cited in Table 5-3.

To summarize, CO<sub>2</sub> emissions from APU are calculated based on the APU operating time, the fuel flow derived by aircraft size, and the CO<sub>2</sub> emissions index.

## 5.2 Ground Support Equipment (GSE)

The methodologies for modeling GSE populations and GSE assigned to aircraft are identical except for how GSE operations are defined.

### 5.2.1 GSE Population Processing Algorithm

GSE populations are uniquely identified by their type (e.g., Cargo Loader), reference model (e.g., FMC Commander 15), and fuel (i.e., CNG, Diesel, Electricity, Gasoline, and LPG). User-defined operational profiles, which represent the quarter-hourly/daily/monthly distribution of the GSE populations' operation time during the modeling period, are used to estimate emissions for each quarter-hour of the specified modeling period. For each year of the user-specified modeling period, AEDT calculates the entire years' operation time using the user-defined operational profiles and the user-specified annual GSE population hours of operation.

The following outline describes the algorithm for processing GSE population emissions. For an illustrative example on how AEDT calculates GSE population emissions, please refer to Appendix 14.

1. Total hours-of-operation weighting calculated per model year using Eq. 5-20.

<sup>xxxii</sup> Doc 9989, Airport Air Quality Manual, Second Edition, ICAO, 2011.

$$W_g = \sum_{i=1}^{365 \text{ (366 if leap year)}} (w_{m_i,g} * w_{d_i,g}) * \sum_{j=1}^{96} w_{q_j,g} \quad \text{Eq. 5-20}$$

where

- $W_g$  Total annual hours-of-operation weight for GSE population  $g$ , summed over all Julian days  $i$  of the year being modeled;
- $w_{m_i,g}$  Weight for month that Julian day  $i$  falls within for the operational profiles assigned to GSE population  $g$ ;
- $w_{d_i,g}$  Weight for day of the week that Julian day  $i$  falls on for the operational profiles assigned to GSE population  $g$ ; and
- $w_{q_j,g}$  Weight for quarter-hour  $j$  of the operational profiles assigned to GSE population  $g$ .

2. Peak quarter-hour operations (Operation-hour-per-weight) are calculated per model year using Eq. 5-21.

$$PeakOpHrs_{q,g} = \frac{OpHrs_g}{W_g} \quad \text{Eq. 5-21}$$

where

- $PeakOpHrs_{q,g}$  Peak quarter-hourly operation time (in hours) for GSE population  $g$ ;
- $OpHrs_g$  User-defined annual hours of operation for GSE population  $g$ ; and
- $W_g$  Total annual hours-of-operation weight for GSE population  $g$  (Eq. 5-18).

3. Total operation per hour needed for emissions dispersion calculated for a particular hour  $j$  of day  $i$  is calculated by multiplying the weight for the hour  $j$ :

$$TotalOpPerHour_j = PeakOpHrs_{q,g} * w_{m_i,g} * w_{d_i,g} * w_{h_j} \quad \text{Eq. 5-22}$$

where

- $w_{h_j}$  hourly profile for hour  $j$  which is the sum of four quarter hourly profile of the hour  $j$ .

AEDT pre-calculates the weight per hour by creating a dictionary of key-value pair where key is Date Time and value is weight for a particular hour of Date Time,  $W_{mdh} = w_{m_i,g} * w_{d_i,g} * w_{h_j}$ . Therefore, emissions for a particular hour of Date Time can be calculated by multiplying the emissions per hour with this weight dictionary lookup.

4. Total hours of operation calculated for the modeling period specified Using Eq. 5-23.

$$TotOpHrs_g = PeakOpHrs_{q,g} \sum_{\text{Julian Day/Time Start}}^{\text{Julian Day/Time End}} (w_{m_i,g} * w_{d_i,g}) * \sum_j w_{q_j,g} \quad \text{Eq. 5-23}$$

where

$TotOpHrs_g$	Total hours of operation for the modeling period specified for GSE population $g$ ;
$PeakOpHrs_{q,g}$	Peak quarter-hourly operation time (in hours) for GSE population $g$ (Eq. 5-21);
$w_{m_i,g}$	Weight for month that Julian day $i$ falls within for the operational profiles assigned to GSE population $g$ ;
$w_{d_i,g}$	Weight for day of the week that Julian day $i$ falls on for the operational profiles assigned to GSE population $g$ ; and
$w_{q_j,g}$	Weight for quarter-hour $j$ of the operational profiles assigned to GSE population $g$ for each Julian day $i$ . Note that the first and last Julian day in the study may not require all quarter-hours in the day be summed together – refer to the start and end times for those two days.

5. GSE population emissions are calculated for the modeling period specified using Eq. 5-24.

$$m_{p,g} = E_{p,g} P_g L_g N_g TotOpHrs_g \quad \text{Eq. 5-24}$$

where

$m_{p,g}$	Total mass (in grams) of pollutant $p$ emitted during the modeling period from GSE population $g$ ;
$E_{p,g}$	Emission factor for pollutant $p$ (in grams per horsepower-hour) for GSE population $g$ ;
$P_g$	Rated power (in brake horsepower) for GSE population $g$ ;
$L_g$	Load factor (unitless) for GSE population $g$ ;
$N_g$	Number of units in GSE population $g$ ; and
$TotOpHrs_g$	Total hours of operation for the modeling period specified for GSE population $g$ (Eq. 5-23).

6. If dispersion is enabled, the fraction of GSE population hourly emissions are added to their assigned gates' hourly emissions (e.g., gate activity of aircraft).

### 5.2.2 Aircraft-Assigned GSE Processing Algorithm

Each aircraft assigned GSE are uniquely identified by the combination of their type, reference model and fuel. The following outline describes the algorithm used to model the emissions of GSE assigned to aircraft. These GSE are modeled on an aircraft operation basis (specifically, only departures and arrivals).

1. Model the assigned GSE emissions with Eq. 5-25 for an arrival or a departure operation.
2. If dispersion is enabled, add the aircraft's GSE emissions to the gate of the flight operation.

$$m_{p,a} = \sum_{g \in A_a} E_{p,g} P_g L_g t_{a,g} \quad \text{Eq. 5-25}$$

where

$m_{p,a}$	The mass (in grams) of pollutant, $p$ , emitted from all GSE assigned to aircraft $a$ during one operation;
-----------	---

---

$A_a$	The set of GSE assigned to aircraft $a$ ;
$E_{p,g}$	The emission factor for pollutant, $p$ (in grams per horsepower-hour) for GSE, $g$ ;
$P_g$	The rated power (in brake horsepower) of GSE, $g$ ;
$L_g$	The load factor (unitless) of GSE, $g$ ; and
$t_{a,g}$	For aircraft $a$ , the number of hours GSE $g$ operates during one operation.

### 5.2.3 GSE Data Sources

In order to calculate GSE emissions, both GSE population and aircraft-assigned GSE require user inputs for rated horsepower, load factor and operating time or number (Eq. 5-24 and Eq. 5-25). Additionally, the pollutant emission factors in grams per horsepower-hour (g/hp-hr) are required. Pollutant emission factors for GSEs are stored in the `StnGseEmissionFactorEffectiveYear` and the `StnGseEmissionFactorNationalAverage` tables.

When modeling system GSEs, users have the option to provide manufacture year. The specification of manufacturer year is the distinction that drives the GSE modeling methodology and determines which table will be used in calculations.

- If manufacture year is not provided, the default average age and emission factors from the `StnGseEmissionFactorNationalAverage` table are used; a deterioration calculation is not performed. This table uses GSE type and fuel type to determine emission factors. Refer to Section 5.2.3.2.
- If manufacture year is provided (which determines the age), emission factors from the `StnGseEmissionFactorEffectiveYear` table are used and a deterioration calculation is performed. In this table, a transient adjustment factor (TAF) is applied in line with EPA guidance. Refer to Section 5.2.3.3 for additional information and references.

#### 5.2.3.1 GSE $SO_x$ Emission Factors

$SO_x$  emission factors are determined by the fuel sulfur content table from the August 2023 EPA report, *Fuel Supply Defaults: Regional Fuels and the Fuel Wizard in MOVES4* (see Table 5-7), to be consistent with EPA's use of MOVES for motor vehicle emissions. Emission factors for both GSEs with default age and GSEs with user-specified manufacture year are based on this table. AEDT stores the sulfur content for GSE sources in two tables: `StnGseFuelSulfurContent` and `StnGseFuelSulfurContentSource`.

Table 5-7 Fuel Sulfur Content by Year and Fuel Type from MOVES4

Year	Fuel Type	Sulfur content by mass (kg/kg)
1997	Gasoline	0.0003126
1998		0.0002727
1999		0.0002838
2000		0.0002702
2001		0.0002641
2002		0.0002594
2003		0.0002438
2004		0.0001120
2005		0.0000948
2006		0.0000492
2007		0.0000399
2008		0.0000342
2009		0.0000333
2010		0.0000324
2011		0.0000300
2017		0.0000100
1999		Diesel
2000	0.002284	
2001	0.002284	
2002	0.002284	
2003	0.002284	
2004	0.002284	
2005	0.002284	
2006	0.002242	
2007	0.001139	
2008	0.000351	
2009	0.000351	
2010	0.000165	
2011	0.000032	
2012	0.000006	
2013	0.000006	
2014	0.000006	
1900	CNG	0.0000076
1900	LPG	0.0000076

Emission factors from diesel, CNG and LPG are the non-road values reported in the *Fuel Supply Defaults* EPA report<sup>46</sup> (Section 7). The emission factors from gasoline are based on the average annual gasoline properties for all U.S. gasoline from Table A-3 in the same EPA report. The sulfur content of gasoline is now dependent on the analysis year. For years not listed:

- If the analysis year is prior to the first year of available data, then the first year of available data is used.
- If the analysis year is after the last year of available data, then the last year of available data is used.

For example, CNG and LPG would use the same emission factor (i.e., 0.0000076 kg/kg fuel) for all analysis years.

### 5.2.3.2 System GSE with Default Age

The StnGseEmissionFactorNationalAverage table stores one record for each GSE type and fuel combination for each study year between 1990 and 2060, inclusive. Emission factors for CO, THC, NO<sub>x</sub>, PM<sub>10</sub>, PM<sub>2.5</sub>, CO<sub>2</sub>, and CH<sub>4</sub> are in units of g/hp-hr. Each GSE was mapped to either a source classification code (SCC) or a regulatory class ID from EPA's MOVES4 modeling system corresponding to an appropriate GSE type and fuel type combination. A complete list of these mappings can be found in Table 5-8 below. The data represent national fleet average emission factors. AEDT calculates SO<sub>x</sub> emission factors based on Table 5-7 (see Section 5.2.3.1) and THC content from StnGseEmissionFactorNationalAverage table.

Table 5-8 Summary of GSE Mappings to SCCs and Regulatory Class IDs within EPA's MOVES4 Model by GSE Type and GSE Fuel Type

GSE Type	GSE Fuel Type	SCC/Regulatory Class IDs
Air Conditioner	Gasoline	2265003060
Air Conditioner	CNG	2268003060
Air Conditioner	Diesel	2270003060
Air Start	Gasoline	2265006015
Air Start	LPG	2267006015
Air Start	CNG	2268006015
Air Start	Diesel	2270006015
Aircraft Tractor	Gasoline	2265003070
Aircraft Tractor	Diesel	2270003070
Aircraft Tractor	CNG	2268003070
Aircraft Tractor	LPG	2267003070
Baggage Tractor	Gasoline	2265003070
Baggage Tractor	Diesel	2270003070
Baggage Tractor	CNG	2268003070
Baggage Tractor	LPG	2267003070
Belt Loader	Gasoline	2265002066
Belt Loader	LPG	2267002066



<b>GSE Type</b>	<b>GSE Fuel Type</b>	<b>SCC/Regulatory Class IDs</b>
Belt Loader	Diesel	2270002066
Cargo Loader	LPG	2267002066
Cargo Loader	Diesel	2270002066
Cargo Loader	Gasoline	2265002066
Cargo Tractor	Gasoline	2265003070
Cargo Tractor	Diesel	2270003070
Cargo Tractor	CNG	2268003070
Cargo Tractor	LPG	2267003070
Forklift	Gasoline	2265003020
Forklift	LPG	2267003020
Forklift	CNG	2268003020
Forklift	Diesel	2270003020
Generator	Diesel	2270006005
GPU	Gasoline	2265006005
GPU	LPG	2267006005
GPU	CNG	2268006005
GPU	Diesel	2270006005
Lift	Gasoline	2265003010
Lift	LPG	2267003010
Lift	Diesel	2270003010
Other	Gasoline	2265008005
Other	LPG	2267008005
Other	Diesel	2270008005
Sweeper	Gasoline	2265003030
Sweeper	Diesel	2270003030
Sweeper	CNG	2268003030
Sweeper	LPG	2267003030
Bobtail	Gasoline	42
Bobtail	Diesel	42
Lavatory Truck	Gasoline	42
Lavatory Truck	Diesel	42
Service Truck	Gasoline	42
Service Truck	Diesel	42
Water Service	Gasoline	42
Water Service	Diesel	42

GSE Type	GSE Fuel Type	SCC/Regulatory Class IDs
Hydrant Truck	Gasoline	41
Hydrant Truck	Diesel	41
Passenger Stand	Gasoline	41
Passenger Stand	Diesel	41
Cabin Service Truck	Gasoline	46
Cabin Service Truck	Diesel	46
Catering Truck	Gasoline	46
Catering Truck	Diesel	46
Deicer	Gasoline	46
Deicer	Diesel	46
Fuel Truck	Gasoline	47
Fuel Truck	Diesel	47
Fuel Truck	CNG	47

To generate the values found in the StnGseEmissionFactorNationalAverage table, the emission factors for each GSE Type/GSE Fuel Type were normalized by the average horsepower by SCC/Regulatory Class ID to give emissions factors in grams per horsepower-hour.

### 5.2.3.3 System GSE with User-Specified Manufacture Year

The StnGseEmissionFactorEffectiveYear table stores zero-hour (i.e., new equipment) emission factors, deterioration factors by fuel, and transient adjustment factors separated into categories by rated horsepower range and year of manufacture range. AEDT locates the applicable record by matching the GSE's fuel type to the "FUEL\_TYPE\_ID" field value, verifying that the GSE's rated horsepower is at least the "MIN\_POWER\_HP" field value and less than the "MAX\_POWER\_HP" value, and verifying that the GSE's manufacture year is at least the "EFFECTIVE\_YEAR" field value.

The equations in this section are based on the EPA technical report, *Exhaust and Crankcase Emissions Factors for Nonroad Compression-Ignition Engines in MOVES3.0.2*<sup>47</sup>.

The CO, THC, and NO<sub>x</sub> emission factors for GSE are calculated as follows:

$$E_{p,g} = \hat{E}_{p,g} TAF [1 + A_{p,g} ((\min\{1, a_g/l_g\})^{B_{p,g}})] \quad \text{Eq. 5-26}$$

where

- $E_{p,g}$  The emission factor for pollutant,  $p$ , and for GSE  $g$  (in grams per horsepower-hour);
- $\hat{E}_{p,g}$  The zero-hour emission factor for pollutant,  $p$ , and GSE,  $g$ ;
- $TAF$  Transient adjustment factor (unitless);
- $A_{p,g}$  The deterioration coefficient for pollutant,  $p$ , and GSE,  $g$  (from the StnGseEmissionFactorEffectiveYear table, DET\_A column)

$B_{p,g}$	The deterioration exponent for pollutant, $p$ , and GSE, $g$ (from the StnGseEmissionFactorEffectiveYear table, DET_B column);
$a_g$	The age (in years) of the GSE, $g$ ;
$l_g$	The median life (in years) of the GSE, $g$ (from the STN_GSE table, USEFUL_LIFE column); and
$p$	$\in \{\text{CO, THC, NO}_x\}$

The PM<sub>10</sub> and PM<sub>2.5</sub> emission factors for GSE are calculated as follows<sup>xxxii</sup>:

$$E_{p,g} = (\hat{E}_{p,g} TAF [1 + A_{p,g} (\min \{1, \frac{a_g}{l_g}\})^{B_{p,g}}]) - S_{PM\ adj} \quad \text{Eq. 5-27}$$

$E_{p,g}$	The emission factor for pollutant, $p$ , and for GSE $g$ (in grams per horsepower-hour);
$\hat{E}_{p,g}$	The zero-hour emission factor for pollutant, $p$ , and GSE, $g$ ;
$TAF$	Transient adjustment factor (unitless);
$A_{p,g}$	The deterioration coefficient for pollutant, $p$ , and GSE, $g$ (from the StnGseEmissionFactorEffectiveYear table, DET_A column)
$B_{p,g}$	The deterioration exponent for pollutant, $p$ , and GSE, $g$ (from the StnGseEmissionFactorEffectiveYear table, DET_B column);
$a_g$	The age (in years) of the GSE, $g$ ;
$l_g$	The median life (in years) of the GSE, $g$ (from the STN_GSE table, USEFUL_LIFE column); and
$S_{PM\ adj}$	Sulfur adjustment factor (g/hp-hr) from Eq. 5-29.

The (non-deteriorated) SO<sub>x</sub> emission factor for GSE is calculated as follows<sup>xxxiii</sup>:

$$E_{SO_x,g} = [W_g(1 - \varepsilon) - E_{THC,g}](S)(M_{SO_2:S}) \quad \text{Eq. 5-28}$$

where

$E_{SO_x,g}$	The emission factor for SO <sub>x</sub> (in grams per horsepower-hour) for GSE, $g$ ;
$W_g$	The brake specific fuel consumption (in grams per horsepower-hour) for GSE, $g$ (from the StnGseEmissionFactorEffectiveYear table, BrakeSpecificFuelConsumption column);
$\varepsilon$	The Sulfur-to-Sulfate Conversion Rate (soxcsv) (unitless, default values in Table 5-9);
$E_{THC,g}$	The emission factor for THC (in grams per horsepower-hour) for GSE, $g$ from Eq. 5-26;
$S$	The fuel sulfur content by mass (soxds1 * 0.01) (unitless) from Table 5-7; and

<sup>xxxii</sup> Equation 2, *Exhaust and Crankcase Emission Factors for Nonroad Compression-Ignition Engines in MOVES3.0.2: Report No. EPA-420-R-21-021*. U.S. EPA, September, 2021. This equation in the EPA document has a typo where the sulfur adjustment factor is multiplied rather than subtracted on page 13. The equation in its correct form is shown in the example calculation on page 34 of the document.

<sup>xxxiii</sup> Equation 7, *Exhaust and Crankcase Emission Factors for Nonroad Compression-Ignition Engines in MOVES3.0.2: Report No. EPA-420-R-21-021*. U.S. EPA, September, 2021.

$M_{SO_2:S}$  The ratio of the mass of a molecule  $SO_2$  to mass of an atom of sulfur (a constant value assumed to be 2.0).

The value of the sulfur content by mass ( $S$ ) is determined by the fuel type given in Section 5.2.3.1. Table 5-9 summarizes the sulfur-to-sulfate conversion rates used in Eq. 5-29. This table is based on data from the 2003 EPA report: “Draft Regulatory Impact Analysis: Control of Emissions from Nonroad Diesel Engines”.

Table 5-9 Sulfur-to-Sulfate Conversion Rates for GSE

Fuel Type	Equipment	Sulfur-to-Sulfate Conversion Rate	Notes
Gasoline	All	0.03	
Diesel	“Truck,” “Stand”, or “Water Service” with analysis year before 2007	0.02247	Pretrap value
Diesel	“Truck,” “Stand”, or “Water Service” with analysis year on or after 2007	0.3	Trapped value
	Other GSE with horsepower $\leq 25$	0.02247	Pretrap value
	Other GSE with horsepower $> 25$ but $\leq 75$ and the analysis year is prior to 2013	0.02247	Pretrap value
	Other GSE with horsepower $> 75$ but $\leq 175$ and the analysis year is prior to 2012	0.02247	Pretrap value
	Other GSE with horsepower $> 75$ but $\leq 175$ and the analysis year is 2012 or 2013	0.161235	Average of Pretrap and Trapped values
	Other GSE with horsepower $> 175$ and the analysis year is prior to 2011	0.02247	Pretrap value
	Other GSE with horsepower $> 175$ and the analysis year is 2011, 2012, or 2013	0.161235	Average of Pretrap and Trapped values
	All other cases	0.3	Trapped value

The  $CO_2$  and  $CH_4$  emissions factors in this table do not require the application of a deterioration factor or a transient adjustment factor.

The final PM emissions require an additional parameter known as the Sulfur Adjustment Factor. This parameter was added to the latest version of the EPA technical report, *Exhaust and Crankcase Emissions Factors for Nonroad Compression-Ignition Engines in MOVES3.0.2*.<sup>xxxiv</sup> This calculated factor will be subtracted from the product of the zero-hour emissions factor, TAF, and deterioration factor in Eq. 5-26 to produce the final emissions factor for  $PM_{10}$  and  $PM_{2.5}$ . The use of this calculated factor is demonstrated on pages 33-34 of the EPA technical report. The Sulfur Adjustment Factor is calculated as follows:

<sup>xxxiv</sup> Exhaust and Crankcase Emission Factors for Nonroad Compression-Ignition Engines in MOVES3.0.2: Report No. EPA-420-R-21-021. U.S. EPA, September, 2021.

$$S_{PM\ adj} = BSFC * 7.0 * soxcnv * (0.01 * soxbas - soxdsl) \quad \text{Eq. 5-29}$$

where

$S_{PM\ adj}$	Particulate matter sulfur adjustment (g/hp-hr);
$BSFC$	In-use adjustment brake-specific fuel consumption (g fuel/hp-hr);
7.0	Grams PM sulfate/grams PM sulfur;
$soxcnv$	Grams PM sulfur/grams fuel sulfur consumed (from the StnGseEmissionFactorEffectiveYear table, PMSulfurConsumedConversionFactor column);
$soxbas$	Certification fuel sulfur weight percent (from the StnGseEmissionFactorEffectiveYear table, CertFuelPMSulfurWeightPercent column); and
$soxdsl$	Fuel sulfur content (unitless), from Table 5-7.

#### 5.2.3.4 User-Defined GSE

The emissions factors for user-defined GSE are stored in the StnGseEmissionFactorNationalAverage table, similar to system GSE with default age. Because the emission factors are looked up, no further computation is required.

#### 5.2.3.5 Factors for Modeling VOC, NMHC, and TOG

Three pollutants, VOC, NMHC, and TOG, are calculated by applying various factors to the THC amount (THC being calculated from the methodology noted above). The pollutant factors are applied based on the GSE fuel type.

THC emissions are used to model NMHC, VOC, and TOG emissions for GSE. Speciated organic gases for GSE are computed based on TOG, see Section 5.4.2.

Table 5-10 Factors for Calculating NMHC, VOC, and TOG, Based on GSE Fuel Type<sup>48</sup>

	NMHC from THC	VOC from THC	TOG from THC
Gasoline	0.9	0.933	1.043
Diesel	0.984	1.053	1.070
CNG	0.048	0.004	1.002
LPG	0.920	0.9953	1.099
Electric	0	0	0

### 5.3 Stationary Sources

This section describes the AEDT process for calculating emissions from stationary sources and training fires. For each scenario-airport combination, the stationary sources and training fires are uniquely identified by their user-specified identification and type (i.e., stationary source or training fire).

The following process is used by AEDT to update emissions totals for stationary sources.

1. If the aircraft schedule is not aggregated:  
For each hour of the day,

- a) Update the atmospheric parameter values with those corresponding to the current day and hour being processed.
  - b) For each stationary source in the in-study list of the scenario-airport combination,
    - i. If the source is not a fuel tank or is a fuel tank with annual throughput/consumption is greater than zero, for each pollutant, compute the annual emissions. Refer to Eq. 5-30.
    - ii. If the source is a fuel tank with zero annual throughput, for each pollutant, compute the annual emissions. Refer to Eq. 5-30.
2. If the aircraft schedule is aggregated:  
 For each stationary source in the in-study list of the scenario-airport combination,
- a) If the source is not a fuel tank or is a fuel tank with annual throughput/consumption is greater than zero, for each pollutant, compute the annual emissions. Refer to Eq. 5-30.
  - b) If the source is a fuel tank with zero annual throughput, for each pollutant, compute the annual emissions. Refer to Eq. 5-30.

The following process is used by AEDT to update emissions totals for stationary sources and training fires.

- 1. If the aircraft schedule is not aggregated:  
 For each hour of the day,
  - a) Loop over all stationary sources and training fires in the In-study list of the scenario-airport:
    - i. For each pollutant, compute the annual emissions. Refer to Eq. 5-30.
- 2. If the aircraft schedule is aggregated:
  - a) Loop over all stationary sources and training fires in the In-study list of the scenario-airport:
    - i. For each pollutant, compute the annual emissions. Refer to Eq. 5-30.

Eq. 5-30 is used to compute annual emissions for an emissions inventory. Table 5-11 lists the units which vary by context.

$$m_{p,s} = EF_{p,s} \cdot \begin{cases} 1 & \text{if } s \text{ is a fuel tank and } N_s = 0 \\ N_s & \text{otherwise} \end{cases} \quad \text{Eq. 5-30}$$

where

- $m_{p,s}$  The mass (in kilograms) of pollutant, p, emitted annually from source, s;
  - $N_s$  The annual throughput/consumption of source, s (see Table 5-11 for units); and
  - $EF_{p,s}$  The emission factor for pollutant, p, for source, s (see Table 5-11 for units).
- Note: if  $N_s = 0$ , then  $EF_{p,s}$  will represent the annual fuel tank emissions.

Table 5-11 Units for Stationary Sources & Training Fires

Source Category	Sub-Category	Emission Factor Units	Throughput Units
Other	All	Kg per the user-specified throughput unit	User-specified
Boiler/Space Heater	Coal Burning	Kg per Metric Ton	Metric Tons
	Fuel Oil or LPG Burning	Kg per Kiloliter	Kiloliters

Source Category	Sub-Category	Emission Factor Units	Throughput Units
	Natural Gas Burning	Kg per 1,000 cubic meters	1,000's of Cubic Meters
Emergency Generator	EPA Methodology	Kg per Hour	Hours
	USAF Methodology (not Natural Gas)	Kg per Kiloliter	Kiloliters
	USAF Methodology (Natural Gas)	g per HP-Hour	1,000's Cubic Meters
Incinerator	All	Kg per Metric Ton	Metric Tons
Aircraft Engine Testing	All	Kg per Test Cycle	Test Cycles
Fuel Tank*	All	Kg per Kiloliter	Kiloliters
Surface Coating/Painting	All	Kg per Kiloliters	Kiloliters
Deicing Area	All	Kg per Kiloliters	Kiloliters
Solvent Degreaser	All	Kg per Kiloliters	Kiloliters
Sand/Salt Pile*	All	Kg per Metric Ton	Metric Tons
Training Fire	All	Kg per Gallon	Gallons

\* For Fuel Tank and Sand/Salt Pile, emission factors are calculated from user-supplied inputs; there is no option to directly enter an emission index.

Annual emissions from a source are generally based on the source's annual throughput or consumption of a substance, time or an event. For more details on stationary sources, refer to Section 13.2.

## 5.4 Speciated Organic Gas (SOG) Emissions

Speciated organic gas (SOG) emissions are calculated for aircraft, ground support equipment, stationary sources, and training fires based on SPECIATE profiles in FAA's Guidance for Quantifying Speciated Organic Gas Emissions from Airport Sources (Table 1).<sup>49</sup>

### 5.4.1 Aircraft

SOG emissions for aircraft<sup>43</sup> are calculated as described in Section 5.1.1.9. SOG emissions from APUs and GSE assigned to aircraft are also computed.

### 5.4.2 Non-Aircraft

For non-aircraft sources (e.g., GSE, stationary sources, and training fires), the total mass of each SOG is computed by multiplying its mass fraction by  $TOG_{TOG}$  emissions. The following stationary sources use a HydrocarbonProfile approach to calculate and/or convert THC, NMHC, VOC, and TOG values: Deicing, Emergency Generator, Incinerator, Fuel Tank, Solvent Degreaser, Surface Coating, and Training Fire. The remaining stationary sources, Boiler Heater, Aircraft Engine Testing, Other, and Salt Sand Pile, use hardcoded default values or direct input data to calculate THC, NMHC, VOC, and TOG.

The following three tables in the AEDT database define speciated hydrocarbon emissions:

- STN\_MASSFRAC – lists all of the speciation profile mass fractions of TOG mass;

- STN\_SPEC\_PROF – lists the names of the speciation profiles; and
- STN\_SPEC\_HC – lists the names and other properties of the speciated organic gases.

The section below describes the SOG emissions methodology for stationary sources associated with a hydrocarbon profile. The hydrocarbon profile indices ( $p = 1, 2, \dots, 27$ ) and their respective names (e.g., Solvent Degreaser) are stored in the STN\_SPEC\_PROF table. If a stationary source's emissions are characterized in terms of an emissions factor  $EF_n$  ( $n = \text{THC, NMHC, VOC or TOG}$ ), the emission factors for the other components,  $EF_{m,p,n}$  ( $m = \text{THC, NMHC, VOC or TOG}$ ), are calculated using the conversion equations below. Note that for sources whose emissions are calculated in terms of VOC instead of TOG (fuel tanks, solvent/degreasers, and surface coating), VOC emissions are first converted to TOG.

$$EF_{tog,p,voc} = \frac{EF_{voc}}{MF_{total,p,voc}} \quad \text{Eq. 5-31}$$

$$EF_{tog,p,thc} = \frac{EF_{thc}}{MF_{total,p,thc}} \quad \text{Eq. 5-32}$$

$$EF_{tog,p,nmhc} = \frac{EF_{nmhc}}{MF_{total,p,nmhc}} \quad \text{Eq. 5-33}$$

$$EF_{voc,p,tog} = EF_{tog} \cdot MF_{total,p,voc} \quad \text{Eq. 5-34}$$

$$EF_{voc,p,thc} = \frac{EF_{thc}}{MF_{total,p,thc}} \cdot MF_{total,p,voc} \quad \text{Eq. 5-35}$$

$$EF_{voc,p,nmhc} = \frac{EF_{nmhc}}{MF_{total,p,nmhc}} \cdot MF_{total,p,voc} \quad \text{Eq. 5-36}$$

$$EF_{thc,p,tog} = EF_{tog} \cdot MF_{total,p,thc} \quad \text{Eq. 5-37}$$

$$EF_{thc,p,voc} = \frac{EF_{voc}}{MF_{total,p,voc}} \cdot MF_{total,p,thc} \quad \text{Eq. 5-38}$$

$$EF_{thc,p,nmhc} = \frac{EF_{nmhc}}{MF_{total,p,nmhc}} \cdot MF_{total,p,thc} \quad \text{Eq. 5-39}$$

$$EF_{nmhc,p,tog} = EF_{tog} \cdot MF_{total,p,nmhc} \quad \text{Eq. 5-40}$$

$$EF_{nmhc,p,voc} = \frac{EF_{voc}}{MF_{total,p,voc}} \cdot MF_{total,p,nmhc} \quad \text{Eq. 5-41}$$

$$EF_{nmhc,p,thc} = \frac{EF_{thc}}{MF_{total,p,thc}} \cdot MF_{total,p,nmhc} \quad \text{Eq. 5-42}$$



The respective total mass fraction coefficients,  $MF_{total,p,m}$ ,  $m = \text{THC, NMHC, VOC}$ , are calculated as follows:

$$MF_{total,p,thc} = \sum_i MF_{i,p}(HC = true) \quad \text{Eq. 5-43}$$

$$MF_{total,p,voc} = \sum_i MF_{i,p}(VOC = true) \quad \text{Eq. 5-44}$$

$$MF_{total,p,nmhc} = \sum_i MF_{i,p}(HC = true, Name \neq "METHANE") \quad \text{Eq. 5-45}$$

where  $i$  is the index of the respective SOG of a given hydrocarbon profiles  $p$ , filter “HC = true” includes in summation only hydrocarbon gases, filter “VOC = true” includes in summation only volatile organic gases, and combined filter “HC = true and Name ≠ “METHANE” includes in summation only non-methane hydrocarbon gases. Mass fractions values are stored in the STN\_MASSFRAC table. The HC and VOC boolean indicators, as well as the name of the gaseous component, are stored in the STN\_SPEC\_HC table, which is linked to the STN\_MASSFRAC through the SOG index,  $i$ .

The only exception to the methodology above is for  $p = 10$ , Gasoline Emergency Generators. For this stationary source, the following hardcoded values are used in place of a hydrocarbon profile:

$$MF_{total,p,thc} = 0.988$$

$$MF_{total,p,voc} = 0.8852$$

$$MF_{total,p,nmhc} = 0.8873$$

### 5.4.3 Calculation of SOG Emissions

SOG calculation is performed when the “Speciated Organic Gases” report button in the AEDT GUI is clicked for a metric result that has been run. The metric result must have operation-level results or event-level results (i.e., the Emissions Results Storage Option is set to Operation or Segment) in order to calculate SOG.

The calculated SOG results are stored in the SOGReport table and presented in SOG report which displays annualized modal-level results (below mixing height) grouped by airports. Users can set a preference to specify whether to limit the SOG report to only those organic gases listed in EPA’s Integrated Risk Information System (IRIS) or display all organic gases for which speciation profiles are available in AEDT.

### 5.4.4 How SOG Is Calculated as Post-Processing

In order to calculate annualized modal-level SOG emissions for each airport, AEDT uses following result types for different emissions sources:

- For aircraft sources, the EmissionsModalResultCollection (Result Type 53) is used to distinguish turbine vs. piston.
- For APU sources, the APU EmissionsEventResult (Result Type 61) is used.

- For GSE LTO sources, the GSELtoEmissionsEventResult (Result Type 62) is used.
- For GSE population sources, the GSEPopEmissionsSummaryResult (Result Type 64) is used.
- For stationary sources, the StationaryEmissionsSummaryResult (Result Type 63) is used.

Runtime to calculate SOG emissions depends on what type of emissions sources are included in the AEDT study.

---

## 6. Emissions Dispersion

AEDT uses the EPA's atmospheric dispersion modeling system, American Meteorological Society (AMS)/EPA Regulatory Model (AERMOD)<sup>50</sup>, for estimating air quality impacts of airport-related emissions. AEDT submits input and receives output from AERMOD and can create pollutant concentration maps near an airport.

### 6.1 AERMOD Emissions Sources

To generate the necessary input files for AERMOD, AEDT allocates airport-related emissions into spatially fixed emission sources that can be read by AERMOD. All emissions are aggregated to each modeling hour, by source, and are converted into AERMOD source-specific emission rates that can vary by hour. These source-specific hourly emission rates are compiled into a single text file referred to as the hourly emission rate file, or simply HRE file, and is referenced in the AERMOD input (control) file, or INP file (refer to Section 6.19 for more detail).

Each aircraft operation (e.g., departure or arrival) is associated with a set of ground and airborne segments. AEDT distributes each segment's emissions between one or more AERMOD sources. The user can select either AREA or VOLUME source types to represent emissions from aircraft operations. When either source type is chosen, all aircraft operations will be characterized by that source type, including taxi segments, runups, ground roll segments, and airborne segments. Users are not able to characterize aircraft operations as a mix of AREA and VOLUME sources within the same model run within AEDT.

For the purpose of emissions dispersion modeling, GSE, APU, and startup operations need to be associated with the appropriate gates or terminals in AEDT. Gates and terminals in AEDT are abstract concepts, which were designed in support of the emissions dispersion and taxi network modeling, and should not be misinterpreted for real airport gates and terminals. A gate is a point AEDT Airport Layout Component and is characterized as a VOLUME source in AERMOD. Contrary to their name, VOLUME sources in AERMOD are intended to model emissions originating from a point with an initial plume dimension and finite concentration. A terminal is a polygonal AEDT Airport Layout Component and is characterized as an AREAPOLY source in AERMOD. A terminal for emissions dispersion purposes is the "apron" (the area where aircraft are parked, unloaded or loaded, refueled, or boarded, near real gates, and it is not a terminal building). For reference, EDMS regarded AEDT gates and terminals as "gates."

Due to a variety of the geometrical and physical characteristics of stationary sources, the emissions from the respective operations could be allocated into VOLUME, AREAPOLY, and/or POINT sources. POINT sources are intended to model stacks with user-specified exhaust temperature, velocity and inside diameter.

AEDT relies on the user to estimate roadway, parking, and construction emissions separately, and produce the respective AERMOD INP and HRE files. The user models roadway, parking, and/or (non-road) construction emissions using the MOVES model<sup>51</sup> and then generates the associated INP and HRE files. Under the Definitions tab in AEDT, the user points to the path of the MOVES-based emissions dispersion files for AEDT to integrate the data within these files into the AERMOD INP and HRE files

generated by AEDT for all other sources at the airport. If roadways are modeled as AREA sources, it should be noted that according to the American Meteorological Society (AMS)/EPA Regulatory Model Improvement Committee (AERMIC) guidance, the proportions of the rectangular regions modeled as AREA sources should be limited to a 10:1 ratio – no AREA should be ten times longer than its width. AEDT follows this guidance for taxiways when aircraft operations are represented by AREA sources.

### 6.1.1 AERMOD Source Groups

AERMOD is able to output results by source groups, in addition to the standard output of all sources grouped together. Several pre-defined source groups are available to the user to select when creating an emissions dispersion metric result in AEDT. Table 6-1 includes a complete list of the various source groups available for aircraft operations, their name as referenced in AERMOD, and a brief description for each. Modes referenced in the table refer to an AEDT flight segment's trajectory mode. AEDT translates the user's selection of source groups to the INP file by defining the respective AERMOD source groups by the unique source IDs associated with each AERMOD source. AEDT also writes the necessary lines to the INP file to generate AERMOD output files by user-selected source groups.

Table 6-1 Source Groups in AEDT and AERMOD

AEDT Source Group	AERMOD Source Group	Source Group Description	AERMOD Source Type
All	ALL	All source groups combined	1 or more AREA or VOLUME source(s)
Operation groups	OPGRP### (### unique for each operation group)	Each source group will contain the operations contained within each individual Operation Group (case)	1 or more AREA or VOLUME source(s)
Aircraft	AIRCRAFT	All aircraft sources including Taxiway, Runway, and Airborne sources, combined	1 or more AREA or VOLUME source(s)
Engine type	FWJET FWTPROP FWPISTON RCTSHAFT RCPISTON	Aircraft sources separated by Aircraft Type (Fixed Wing versus Rotorcraft) and by aircraft engine type	1-5 AREA or VOLUME source(s) (depending on the number of engine type groups)
Airborne	AIRALL	All airborne aircraft sources including Takeoff ground roll, Takeoff airborne, Climb-out, Airborne approach, and Landing ground roll source groups, combined	1 or more AREA or VOLUME source(s)
Runways	RUNWAY	Aircraft sources including Takeoff and Landing ground roll source groups, combined	1 or more AREA or VOLUME source(s)
Gates	GATES	All sources assigned to gates including Startup, GSE, and APU sources, combined	VOLUME

AEDT Source Group	AERMOD Source Group	Source Group Description	AERMOD Source Type
Taxiways	TAXI	All aircraft taxing sources in taxi modes including Taxi-out and Taxi-in source groups, combined	1 or more AREA or VOLUME source(s)
Takeoff ground roll	TAKOFFGD	Aircraft sources in takeoff ground modes (TakeoffGroundRoll, DepGndDelay)	1 or more AREA or VOLUME source(s)
Takeoff airborne	TAKOFFAR	Aircraft sources in TakeoffAirborne mode	1 or more AREA or VOLUME source(s)
Climb-out	CLIMBOUT	Aircraft sources in climb modes (TerminalClimb, EnrouteClimb, Cruise)	1 or more AREA or VOLUME source(s)
Landing ground roll	LNDNGGD	Aircraft sources in landing ground roll modes (LandingGroundRoll, LandingGroundRollWithReverseThrust, ArrGndDelay)	1 or more AREA or VOLUME source(s)
Airborne approach	LNDNGAR	Aircraft sources in airborne approach modes (Approach, EnrouteDescent, ArrAirDelay)	1 or more AREA or VOLUME source(s)
Taxi-in	TAXIIN	Arrival taxing sources in TaxiIn mode	1 or more AREA or VOLUME source(s)
Taxi-out	TAXIOUT	Departure taxing sources in TaxiOut– mode	1 or more AREA or VOLUME source(s)
Runup - Preflight Check	RUNUPPRE	Runup – preflight check sources	1 or more AREA or VOLUME source(s)
Runup - Engine Maintenance	RUNUPTST	Runup – engine maintenance sources	1 or more AREA or VOLUME source(s)
Stationary sources	STATSRCS	Stationary sources	POINT, VOLUME, or AREAPOLY
Training fires	TFIRE	Training fires	POINT
Background concentrations	BACK	Background concentrations	BACKGRND
Parking facilities	PARKING	Parking facility links (from MOVES)	1 or more AREAPOLY(s)
Roadways	ROADWAYS	Roadway links (from MOVES)	1 or more AREA(s)
Construction	CONSTRUC	Construction activity (from MOVES)	VOLUME

An AERMOD source group will be created in the AERMOD.INP file if at least one source of this type is present. The following Figure demonstrates an example where there at least one source for each source group is present, thus AEDT creates all source groups available.

Figure 6-1 Source Groups in the AERMOD.INP File

```

** -----
** SOURCE GROUP DEFINITIONS:
** -----
SRCGROUP ALL
SRCGROUP AIRCRAFT CUB00001-CUB00389
SRCGROUP AIRCRAFT CUB00394-CUB00686
SRCGROUP AIRCRAFT TFJ00001-TFJ00505
SRCGROUP RUNWAY CUB00001-CUB00104
SRCGROUP RUNWAY CUB00337-CUB00389
SRCGROUP RUNWAY CUB00398-CUB00480
SRCGROUP RUNWAY CUB00539-CUB00628
SRCGROUP AIRALL CUB00105-CUB00336
SRCGROUP AIRALL CUB00394-CUB00397
SRCGROUP AIRALL CUB00481-CUB00538
SRCGROUP AIRALL CUB00629-CUB00686
SRCGROUP RUNUPTST CUB00391-CUB00392
SRCGROUP RUNUPPRE CUB00390
SRCGROUP RUNUPPRE CUB00393
SRCGROUP TAKOFFGD CUB00001-CUB00104
SRCGROUP TAKOFFGD CUB00398-CUB00480
SRCGROUP TAKOFFGD CUB00539-CUB00628
SRCGROUP TAKOFFAR CUB00105-CUB00146
SRCGROUP TAKOFFAR CUB00173-CUB00199
SRCGROUP TAKOFFAR CUB00205-CUB00212
SRCGROUP TAKOFFAR CUB00394-CUB00397
SRCGROUP TAKOFFAR CUB00481-CUB00516
SRCGROUP TAKOFFAR CUB00629-CUB00665
SRCGROUP CLIMBOUT CUB00147-CUB00172
SRCGROUP CLIMBOUT CUB00200-CUB00204
SRCGROUP CLIMBOUT CUB00517-CUB00537
SRCGROUP CLIMBOUT CUB00666-CUB00686
SRCGROUP LNDNGGD CUB00337-CUB00389
SRCGROUP LNDNGAR CUB00213-CUB00336
SRCGROUP LNDNGAR CUB00538
SRCGROUP TAXI TFJ00001-TFJ00505
SRCGROUP TAXIOUT TFJ00001-TFJ00148
SRCGROUP TAXIOUT TFJ00293-TFJ00505
SRCGROUP TAXIIN TFJ00149-TFJ00292
SRCGROUP GATES GATE_001-GATE_011
SO FINISHED

```

## 6.2 AEDT Map Projection

AEDT generally uses a geographic coordinate system (i.e., latitude and longitude), while AERMOD uses a projected coordinate system (Earth's spherical surface projected onto a two-dimensional Cartesian coordinate plane). Thus, it is necessary to convert coordinates between the geographic coordinate system and the projected coordinate system. Note that in this section, upper-case X,Y,Z refers to a particular coordinate system, and lower case x,y,z refers to a particular point in that system.

AEDT uses an approximate Lambert Conformal Conic projection. The projection is not exactly conformal (non-angle-preserving) but is accurate to within one hundred miles around the origin. Refer to Section 14 for more details.

## 6.3 Emissions from Airborne and Ground Roll Flight Segments

Aircraft operations modeling in AEDT is three-dimensional in space to better represent reality. To accommodate the three-dimensional flight trajectories, AEDT constructs two voxel grids to allocate emissions into various AREA or VOLUME sources – a three-dimensional voxel grid and a two-dimensional voxel grid.

### 6.3.1 Three-Dimensional Voxel Grid

The three-dimensional voxel grid is designed to collect emissions from airborne segments. Its origin and coordinate axes coincide with the origin and coordinate axes of the Cartesian coordinate system associated with the AEDT projection, where the Z-coordinate represents the airport field elevation in MSL. The top of the grid is capped at AEDT's default mixing height,  $h_{mixing}$ , of 3,000 ft AFE. The horizontal dimensions of the grid are determined by the maximum extent of the modeled flight segments.

Each cell of the grid is a cuboid with dimensions  $\Delta x$ ,  $\Delta y$ , and  $\Delta z$ . The dimensions of the cuboid are also referred to as spacings and can be changed by the user through the Emissions Dispersion Preferences pane of the Study tab (refer to Section 4.11 of the AEDT User Manual<sup>1</sup>). Consistent with the former EDMS guidelines, AEDT uses a default  $\Delta z$  spacing of 20 m for cuboids located less than 300 m AFE, but allows the user to modify this value. For the cuboids located above 300 m AFE,  $\Delta z$  extends to the AEDT default mixing height and cannot be changed by the user,  $\Delta z = h_{mixing} - 300 \text{ meters}$ . The default (and recommended) horizontal spacing is 200 m for both  $\Delta x$  and  $\Delta y$ .

Location and parameters of the corresponding AERMOD source representing emissions within each cuboid of the grid are determined as follows:

- Find the (X,Y) projection of the cuboid.
- Find the (x,y) location in meters of the lower left corner of the projection.
- Set the  $x_a$ ,  $y_a$ ,  $z_a$  coordinates, where  $z_0$  is the airport field elevation relative to mean sea level in meters, to:
  - If AREA:  $(x - \frac{\Delta x}{2})$ ,  $y$ , and  $z_0$ ; or
  - If VOLUME:  $x$ ,  $(y + \frac{\Delta y}{2})$ , and  $z_0$ .
  - Note: every AREA and VOLUME source has the same location for each cuboid in a given column of the cuboids defined by the same (x,y) coordinates.
- Set the initial vertical dispersion dimension to:
  - 4.1 meters for AREA sources, or
  - 14 meters for VOLUME sources (can be modified by user in the *AircraftVolumeDispersionDimension* study database table by operation mode and wing-engine type combination)<sup>xxxv</sup>.
- For VOLUME sources only, set the initial lateral dispersion dimension to the calculated value as determined by dividing the length of side of the volume source in meters (AEDT default is 200 m) by the initial lateral dispersion dimension ratio of 4.3 (EPA-suggested value as described in the AERMOD User's Guide).
- Set the horizontal dimensions to:
  - If AREA:  $\Delta x$  for width and  $\Delta y$  for length, or
  - If VOLUME: length of side.

<sup>xxxv</sup> When VOLUME source characterization is enabled, AEDT accumulates emissions for each distinct spatial location by unique combinations of aircraft operation mode, wing type, and engine type. The aircraft operation modes defined in AEDT are *Taxi*, *GroundRoll*, and *Airborne* and the wing-engine types defined in AEDT are *FixedWingJet*, *FixedWingTurboprop*, *FixedWingPiston*, *RotorcraftTurboshaft*, and *RotorcraftPiston*. When creating accumulated emissions sources for modeling in AERMOD, AEDT creates as many sources for each taxi segment or voxel cuboid as there are unique wing-engine types with emissions.

- For AREA sources only, set orientation angle to zero.
- Set release height to the average of the ceiling and floor of the current cuboid, plus 12 m.

### 6.3.2 Two-Dimensional Voxel Grid

The two-dimensional voxel grid is designed to allocate the emissions from arrival and departure ground roll segments. It also includes emissions from runup operations, which for the purpose of emissions dispersion are treated as aircraft operations with a single ground roll segment (of zero length) and zero speed. These ground-based flight movements have more impact on the air quality close to the airport and require a finer grid compared to the airborne flight movements. The origin of the grid and its coordinate axes, X and Y, coincide with the origin and coordinate axes of the Cartesian coordinate system associated with the AEDT projection. The elevation of each node of the grid is equal to the airport field elevation,  $z_0$ . The horizontal dimensions of the voxel grid are determined by the maximum extent of the modeled flight segments.

Each cell of the grid is a rectangle with dimensions  $\Delta x$  and  $\Delta y$ . The dimensions of the cell are also referred to as spacings and can be changed by the user through the Emissions Dispersion Preferences pane of the Study tab (refer to Section 4.11 of the AEDT User Manual<sup>1</sup>). The default (and recommended) value for the horizontal spacings is 20 m for both  $\Delta x$  and  $\Delta y$ .

Location and parameters of the corresponding AERMOD source representing emissions within each cell of the grid follow the same steps as outlined for the three-dimensional voxel grid (Section 6.3.1), except that the release height is fixed to 12 m.

### 6.3.3 Voxel Grids Aligned with a Runway

The AEDT unit of work is a metric result. If a metric result contains only the air operations of one type, arrival or departures, and they are all associated with one runway end, then the user has the option to align the voxel grids with the runway. This mode is recommended when comparing the AEDT and EDMS results of the emissions dispersion modeling of straight-in and straight-out flights.

#### 6.3.3.1 Three-Dimensional Aligned Voxel Grid

The origin of the voxel grid is placed in the departure or arrival runway end depending on the type of operations included in the metric result. The  $\tilde{Y}$  axis of the voxel grid is aligned with the runway and oriented in the direction of the other runway end. Orientation angle,  $\varphi$ , of the axis  $\tilde{Y}$  relative to the axis Y of the coordinate system associated with the AEDT projection, measured positive in the clockwise direction, is calculated as follows:

$$\varphi = \arctan\left(\frac{x_e - x_{e,o}}{y_e - y_{e,o}}\right) \quad \text{Eq. 6-1}$$

where  $(x_e, y_e)$  and  $(x_{e,o}, y_{e,o})$  are the AEDT projection coordinates of the runway end and of the other runway end, respectively. The  $\tilde{Z}$  axis of voxel grid is parallel to the Z axis of the coordinate system associated with the AEDT projection and is still the airport field elevation in MSL.



The dimensions of the grid, and  $\Delta\tilde{y}$  and  $\Delta\tilde{z}$  dimensions of each grid's cell or cuboid are set as in Section 6.3.1. The recommended default value of the cuboid's width,  $\Delta\tilde{x}$ , is equal to 20 m. In the use case of straight-in or straight-out flights, the grid dimension in  $\tilde{X}$  direction is equal to the cuboid's width,  $\Delta\tilde{x}$ .

Locations of the AREA or VOLUME sources need to be reported in terms of the coordinate system associated with the AEDT projection. This requirement results in the following modification of the algorithm described in Section 6.3.1:

- Find the  $(\tilde{X}, \tilde{Y})$  projection of the cuboid.
- Find the location in meters,  $(\tilde{x}, \tilde{y})$ , of the lower left corner of the projection.
- Note that for a straight-in or straight-out flight, the following is true:  $\tilde{x} = 0$ .
- Set the  $x_a$ ,  $y_a$ , and  $z_a$  coordinates of the source as follows:
  - If AREA:

$$\begin{aligned}x_a &= \left(\tilde{x} - \frac{\Delta\tilde{x}}{2}\right) \cos(\varphi) + \tilde{y} \sin(\varphi) + x_e \\y_a &= -\left(\tilde{x} - \frac{\Delta\tilde{x}}{2}\right) \sin(\varphi) + \tilde{y} \cos(\varphi) + y_e \\z_a &= z_e\end{aligned}\tag{Eq. 6-2}$$

where  $z_e$  is the mean sea level elevation in meters of the airport.

- If VOLUME:

$$\begin{aligned}x_a &= \tilde{x} \cos(\varphi) + \left(\tilde{y} + \frac{\Delta\tilde{y}}{2}\right) \sin(\varphi) + x_e \\y_a &= -\tilde{x} \sin(\varphi) + \left(\tilde{y} + \frac{\Delta\tilde{y}}{2}\right) \cos(\varphi) + y_e \\z_a &= z_e\end{aligned}\tag{Eq. 6-3}$$

where  $z_e$  is the mean sea level elevation in meters of the airport.

Note that every AREA and VOLUME source has the same location for each cuboid in a given column of the cuboids defined by the same  $(\tilde{x}, \tilde{y})$  coordinates of the projection.

- Set the initial vertical dispersion parameters as outlined in Section 6.3.1.
- If AREA, set the width and length of the source to  $\Delta\tilde{x}$  and  $\Delta\tilde{y}$ , respectively.
- If VOLUME, set the length of side of the source to  $\Delta\tilde{x} = \Delta\tilde{y}$ .
- If AREA, set orientation angle of the source to the runway's orientation angle,  $\varphi$ , Eq. 6-1.
- Release height,  $h$ , is set equal to the average of the ceiling and floor of the current cuboid plus 12 m:

$$h = \tilde{z} + \frac{\Delta\tilde{z}}{2} + 12\tag{Eq. 6-4}$$

### 6.3.3.2 Two-Dimensional Aligned Surface Voxel Grid

AEDT follows the EDMS guidelines in the construction of the aligned surface grid.

Runway ends for the given runway are ordered alphabetically, and the origin of the grid is placed into the first runway end. For example, if a runway has ends named “12” and “30”, the grid origin will be placed into the runway end “12”. The  $\tilde{Y}$  axis of the voxel grid is aligned with the runway and oriented in the direction of the other runway end. Orientation angle,  $\varphi$ , of the axis  $\tilde{Y}$  relative to the axis  $Y$  of the coordinate system associated with the AEDT projection, measured positive in the clockwise direction, is calculated according to Eq. 6-1.

Each cell of the grid is a rectangle with the dimensions  $\Delta\tilde{x}$  and  $\Delta\tilde{y}$ . The default recommended value of the width of each rectangle,  $\Delta\tilde{x}$ , is equal to 20 m. The length of each rectangle,  $\Delta\tilde{y}$ , is calculated dynamically by splitting the length of the runway,  $L$ , into the whole number of segments with maximum desirable length of 50 m. Because the ground roll movements are always confined to the respective runway, the effective width and length of the surface voxel grid are equal to  $\Delta\tilde{x}$  and  $L$ , respectively.

Locations of the AREA or VOLUME sources need to be reported in terms of the coordinate system associated with the AEDT projection. This requirement results in the following modification of the algorithm described in Section 6.3.2:

- The location of the lower left corner of a rectangle is defined as  $(0, \tilde{y})$  because this side of the rectangle resides on the runway.
- Set the  $x_a$ ,  $y_a$ , and  $z_a$  coordinates of the source as follows:
  - If AREA:

$$\begin{aligned}x_a &= -\frac{\Delta\tilde{x}}{2}\cos(\varphi) + \tilde{y}\sin(\varphi) + x_e \\y_a &= \frac{\Delta\tilde{x}}{2}\sin(\varphi) + \tilde{y}\cos(\varphi) + y_e \\z_a &= z_e\end{aligned}\tag{Eq. 6-5}$$

- If VOLUME:

$$\begin{aligned}x_a &= \tilde{x}\cos(\varphi) + \frac{\Delta\tilde{y}}{2}\sin(\varphi) + x_e \\y_a &= -\tilde{x}\sin(\varphi) + \frac{\Delta\tilde{y}}{2}\cos(\varphi) + y_e \\z_a &= z_e\end{aligned}\tag{Eq. 6-6}$$

- Set the initial vertical dispersion parameters as outlined in Section 6.3.1.
- If AREA, set the width and length of the source to  $\Delta\tilde{x}$  and  $\Delta\tilde{y}$ , respectively.
- If VOLUME, set the length of side of the source to  $\Delta\tilde{x} = \Delta\tilde{y}$ .
- If AREA, set orientation angle of the source to the runway’s orientation angle,  $\varphi$ , Eq. 6-1.
- Release height,  $h$ , is set equal to 12 m.

#### 6.3.4 Allocating Emissions from Flight Segments

This section describes the algorithm of allocating the emissions from a flight segment between the AERMOD sources of a voxel grid ( $X, Y, Z$ ). AEDT and EDMS conceptually use the same splitting algorithm.

EDMS implements a two-dimensional version of the splitting algorithm, while AEDT implements a three-dimensional version of the splitting algorithm.

As AEDT does not account for terrain within the dispersion workflow, translations are necessary to effectively create a flat modeling surface and ensure reported receptor concentrations are not overestimated by ensuring that release height is above the airport field elevation. Prior to splitting, AEDT translates the entire flight path in the z-direction by an amount equal to the difference between the airport field elevation and the elevation of the runway end assigned to the operation. For example, an operation assigned to a runway end with an elevation of 50 m MSL at an airport where airport field elevation was 60 m MSL would have the entire flight path translated 10 m in the z-direction. For a runway end that has an elevation equal to the airport field elevation, there would be no translation as the difference between these two elevations is zero. This methodology assumes that users place receptors at the airport field elevation. These translations are not reported in any metric result reports or stored in the AEDT database. Segment altitudes reported in metric result tables are still based on the calculated elevations from the APM.

The flight vector segment  $\vec{S}$  is defined in terms of its orthogonal projection to coordinate axes:

$$\vec{S} = \{S_x, S_y, S_z\} \quad \text{Eq. 6-7}$$

Nodes of each axis splits the respective projection into sub-segments which is expressed as the respective arrays of fractions,  $f_x, f_y, f_z$ . For example, for the X projection:

$$f_x = \{0, f_{x,1}, f_{x,2}, \dots, f_{x,n_x}, 1\} = \left\{0, \frac{S_{1,x} - S_{0,x}}{|S_x|}, \frac{S_{2,x} - S_{0,x}}{|S_x|}, \dots, \frac{S_{n_x,x} - S_{0,x}}{|S_x|}, 1\right\} \quad \text{Eq. 6-8}$$

where:  $S_{1,x}, S_{2,x}, \dots, S_{n_x,x}$  are the coordinates of the X axis nodes intersecting with the  $S_x$  projection of the vector  $\vec{S}$ , and the  $S_{0,x}$  is the x coordinate of the vector's starting point,  $S_0$ . According to the triangle proportionality theorem, a set of the parallel planes, which are perpendicular to the X axis and cross the nodes  $S_{i,x}$ , where  $i = 1, 2, \dots, n_x$ , intersect with the segment vector  $\vec{S}$  in the points  $S_i$  which positions along the segment could be defined as follows:

$$\frac{|\vec{S}_i|}{|\vec{S}|} = f_{x,i}, \quad i = 1, 2, \dots, n_x \quad \text{Eq. 6-9}$$

where  $\vec{S}_i$  is the vector originating in the point  $S_0$ , and ending in the point  $S_i$ . In the same manner, the fraction arrays  $f_y$  and  $f_z$  will define the intersections of the vector  $\vec{S}$  with the node planes perpendicular to the Y and Z axes, respectively. The combined array of all the fractions values sorted in ascending order,  $f$ , comprises the list of all the flight segment vector intersections with the cuboids of the voxel grid:

$$f = \{0, f_1, f_2, \dots, f_n, 1\} = \{0, \frac{|S_1|}{|S|}, \frac{|S_2|}{|S|}, \dots, \frac{|S_n|}{|S|}, 1\} \tag{Eq. 6-10}$$

The intersection points are sorted in the ascending order of their distance from the vector’s starting point,  $S_0$ , and split the segment into the sub-segments as follows:

$$\Delta S = \{\overrightarrow{\Delta S_1}, \overrightarrow{\Delta S_2}, \dots, \overrightarrow{\Delta S_n}, \overrightarrow{\Delta S_{n+1}}\} = \{\overrightarrow{S_1}, \overrightarrow{S_2} - \overrightarrow{S_1}, \dots, \overrightarrow{S_n} - \overrightarrow{S_{n-1}}, \overrightarrow{S} - \overrightarrow{S_n}\} \tag{Eq. 6-11}$$

The above algorithm of splitting the flight segment into the sub-segments is illustrated in Figure 6-2 by an example of the departure, straight-out flight segment intersections with the cuboids of the voxel grid aligned with the runway along the axis Y:

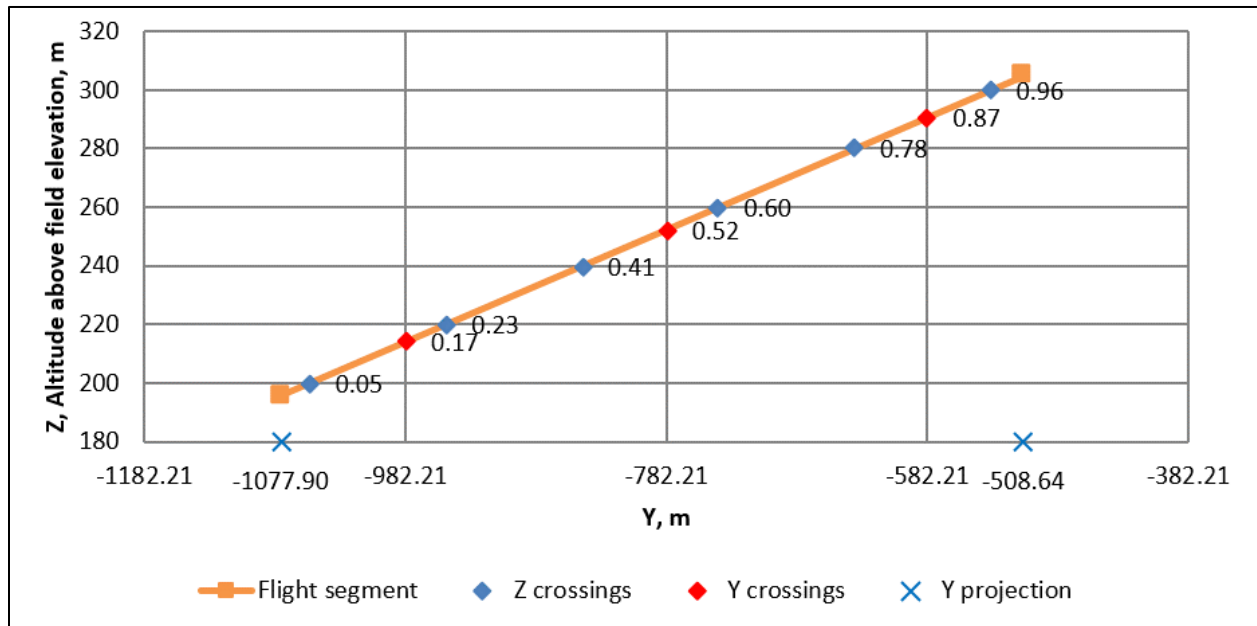

Figure 6-2 Flight Segment Splitting Algorithm

The equation to calculate the time  $t_i$  spent along each sub segment  $\overrightarrow{\Delta S_i}$  is deduced in EDMS and is based on the assumption of constant acceleration along the flight segment (refer to Section 3.3.1. “Aircraft Flight Emissions Allocation”, Equation 3-1, of the EDMS Technical Manual<sup>52</sup>). Emissions of each sub-segment,  $E_i$ , is proportional to the fraction of the total segment time spent along the sub-segment:

$$E_i = \frac{\Delta t_i}{\Delta t_{seg}} E \tag{Eq. 6-12}$$

where

- E Total segment emissions; and
- $\Delta t_{seg}$  Total segment duration.

A sub-segment's emissions are allocated to the AERMOD source associated with the cuboid containing the sub-segment. Per EDMS guidelines, the emissions are collected separately for each modeling hour, and the emissions are converted into rate units under the approximation of a continuous emissions source during each hour. For example, when aircraft operations are characterized as AREA sources:

$$E_a(x, y, z, t) = \frac{1}{3600} \frac{1}{A} \sum_i E_i(C(x, y, z), t) \quad \text{Eq. 6-13}$$

where summation is over all sub-segments,  $i$ , which share the same cuboid,  $C(x, y, z)$ , and the same hour bin,  $t$ , and the parameters of the equation read as follows:

$x, y, z$	Coordinates of the lower-left corner of a cuboid's floor;
$t$	Hour of the operation (1, 2, ..., 24);
$E_a(x, y, z, t)$	Hourly emissions rate of the AREA sources associated with the cuboid;
3,600	Number of seconds in an hour;
$A$	Area of the AREA source in square meters; and
$E_i(C(x, y, z), t)$	Emissions in grams, from a sub-segment $i$ allocated to cuboid $C(x, y, z)$ and the hour bin $t$ .

## 6.4 Emissions from Runup Operations

In emissions dispersion modeling, runup operations are treated as aircraft operations with a single ground roll segment and zero speed (refer to Section 6.3.2 Two-Dimensional Voxel Grid). It should be noted that AEDT only allows runups to be in their own source group (if selected during the creation of the dispersion metric result), other than the "All" category. Runups are not combined with any of the other airport-related source groups. They are split into either the "Preflight Check" or "Engine Maintenance" source groups based on the user's assignment of the runup type during creation of the runup operation.

## 6.5 Emissions from Taxi Segments

To model the taxi emissions dispersion, the respective emissions dispersion metric result should have the Delay and Sequencing model enabled. To enable, the user needs to check the "Apply Delay & Sequencing Model" option when defining a new emissions dispersion metric result.

For each flight, the Delay and Sequencing Module (DSQM) constructs the path from the assigned gate to the respective runway end through the taxi network map, as described in Section 7.3.2.9 Step 9 – Generation of Network Map and Section 7.6.1 Sequencing Algorithm and Outputs. Conceptually, the taxi network map consists of the nodes and allowed connections between the nodes, called links. Each network link has the following major properties: unique ID, reference to the respective airport layout, length ( $L$ ), width ( $w$ ), and coordinates of the connected nodes in the Cartesian coordinate system associated with the AEDT projection. Each link is also characterized with the constant speed at which an aircraft moves along the segment. The DSQM stores the list of the possible links with respective properties into the TAXI\_NETWORK\_LINKS table of the Study database.

Upon the completion of the Aircraft Performance Modeling (APM), the flight's network path is transformed into the list of the taxi trajectory segments and incorporated into the list of the ground roll

and airborne trajectory segments of the respective Performance Event Result. Each taxi trajectory segment includes a reference to the ID of the respective network link. The Aircraft Emissions Module (AEM) processes the performance Event Result, and computes the emissions Event Result which contains emissions,  $E$ , of each pollutant. Both Event Results are stored in the Study database.

AEDT retrieves the emissions and performance Event Results from the database. The emissions from the ground roll and airborne trajectory segments are allocated to the AERMOD sources that represent the voxel grid as explained in Section 6.3. Allocating emissions from the taxi trajectory segments does not require a voxel grid of the AERMOD sources. In this case, the list of the taxi network links, retrieved from the TAXI\_NETWORK\_LINKS table of the Study database, serves as a container of the AERMOD sources. Each taxi trajectory segment references a network link, and each link could be shared by more than one flight.

Each taxi network link between the nodes  $p$  and  $q$ ,  $\lambda_{p,q}$ , is first split into a set of rectangular sources according to the algorithm described in Section 13.1, Constructing AERMOD Rectangle Sources from a Line Segment. The algorithm determines the location  $(x,y,z)$ , elevation, length, and orientation of each rectangular source. When taxi emissions are modeled in AERMOD as AREA sources, these rectangular sources are translated into AREA sources as-is. When the VOLUME source type is selected, the rectangular sources are split into multiple VOLUME sources with equal length and width; thus, for a given taxi network link there will be more sources defined when using the VOLUME source type instead of AREA. The parameters of each source follow the same assignment as detailed in Section 6.3.2 Two-Dimensional Voxel Grid. Each AERMOD source constructed from a link has the same hourly emissions rate,  $E_{p,q}(x, y, z, t)$ , and is expressed in the units of grams per second per square meter (when AREA sources used) or grams per second (when VOLUME sources used). When AREA sources are used to represent taxi emissions, hourly emissions by source are computed following Eq. 6-14:

$$E_{p,q}(x, y, z, t) = \frac{1}{3600} \frac{1}{Lw} \sum_i E_{i,p,q}(x, y, z, t) \quad \text{Eq. 6-14}$$

where  $L$  is the length and  $w$  is width of the source, and  $E_{i,p,q}(x, y, z, t)$  is the emissions for  $i^{th}$  flight in grams, and the emissions from all the flights which share the same taxi network link,  $\lambda_{p,q}$ , and the same hour bin,  $t$ , are accumulated. When VOLUME sources are used to represent taxi emissions, Eq. 6-14 holds true, except  $L$  and  $w$  are excluded.

## 6.6 Emissions from Gates and Terminals

To model emissions dispersion from engine startup, APU, and/or GSE emissions, the user needs to create an emissions dispersion metric result that includes operations that either implicitly or explicitly reference engine startup, APU, and/or GSE equipment. In addition, a gate or a terminal must be assigned to each operation.

In AEDT, the physical gate object could be abstracted either as a point AEDT Airport Layout Component called Gate, or as a polygonal AEDT Airport Layout Component called Terminal. The Gate component is characterized by the location, elevation, release height, and initial vertical and horizontal dispersion dimensions. The Terminal component is characterized by the location of each polygon point, the gate location which is set to the location of the first point of the Terminal, elevation, release height, and the initial vertical dispersion dimension. Note that both the Gate and Terminal components are referred to

as Gates in the Wizard dialogs in AEDT GUI where they get assigned to the respective operation. New gates can be created through the AEDT GUI, an ASIF, or directly in the SQL database.

The engine startup emissions is computed based on the engine thrust characteristics and does not require creation of specific equipment.

As highlighted in Figure 6-3, the user can create a new APU using the Copy feature of the Non-Aircraft pane of the Equipment tab.

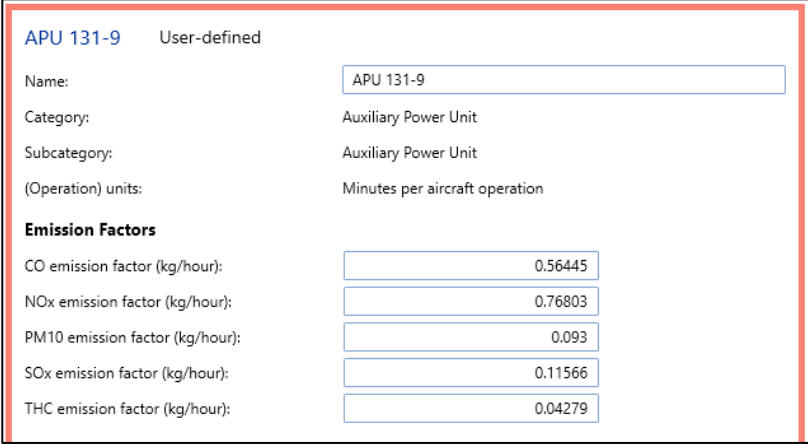

APU 131-9 User-defined	
Name:	APU 131-9
Category:	Auxiliary Power Unit
Subcategory:	Auxiliary Power Unit
(Operation) units:	Minutes per aircraft operation
<b>Emission Factors</b>	
CO emission factor (kg/hour):	0.56445
NOx emission factor (kg/hour):	0.76803
PM10 emission factor (kg/hour):	0.093
SOx emission factor (kg/hour):	0.11566
THC emission factor (kg/hour):	0.04279

Figure 6-3 Creation of a New User-Defined APU

A new APU can also be created via ASIF import or directly in the SQL database. In addition, if the AEDT Study is created by means of the EDMS to ASIF Converter (refer to Appendix C.2: “EDMS to ASIF Converter” of the AEDT User Manual<sup>1</sup>), all the user-defined APUs in the EDMS study will be transformed into the user-defined APUs in AEDT. A system or user-defined APU could be assigned to the new user-defined aircraft using the Copy feature of the Aircraft pane of the Equipment tab. Alternatively, this assignment occurs during the ASIF import process.

As highlighted in Figure 6-4, the user can create a new GSE using the Copy feature of the Non-Aircraft pane of the Equipment tab.

Diesel - ACE 802 - Air Conditioner		User-defined
Name:	<input type="text" value="Diesel - ACE 802 - Air Conditioner"/>	
Category:	Ground Support Equipment	
Subcategory:	Diesel - ACE 802 - Air Conditioner	
<b>Equipment Specifications</b>		
Fuel type:	<input type="text" value="Diesel"/>	
Default horsepower (hp):	<input type="text" value="300"/>	
Default load factor:	<input type="text" value="0.75"/>	
Useful life (years):	<input type="text" value="13"/>	
Default usage (hours/year):	<input type="text" value="808"/>	
<b>Emission Factors</b>		
CO emission factor (g/hp-hr):	<input type="text" value="3.1106"/>	
NOx emission factor (g/hp-hr):	<input type="text" value="4.62074"/>	
PM10 emission factor (g/hp-hr):	<input type="text" value="0.68142"/>	
PM2.5 emission factor (g/hp-hr):	<input type="text" value="0.66098"/>	
THC emission factor (g/hp-hr):	<input type="text" value="0.85529"/>	
CH4 emission factor (g/hp-hr):	<input type="text" value="0.00405"/>	
CO2 emission factor (g/hp-hr):	<input type="text" value="352.14894"/>	

Figure 6-4 Creation of a New User-Defined GSE

A new GSE can also be created via ASIF import or directly in the SQL database. In addition, if the AEDT Study is created by means of the EDMS to ASIF Converter, all the user-defined GSE in the EDMS study will be transformed into the user-defined GSE in AEDT.

Startup emissions modeling is activated for departure operations by enabling the “Calculate aircraft engine startup emissions” option of a metric result. The Startup Emissions Event Result is computed by the Startup Emissions Processor. In the Accumulate Metrics Module (AMM), the Startup Emissions Event Result is encapsulated into an Emissions Model Result with Emissions Flight Mode set to Startup, and added to the Emissions Model Result Collection, which is stored into the database by the Business Logic Level (BLL) Module.

The APU emissions modeling is activated by enabling the “Use Auxiliary Power Unit (APU)” checkbox option and specifying the duration in minutes on the “Choose GSE/APU” step of the “Create Aircraft Operation” wizard (refer to Section 6.2.1 “Create Single or Multiple Aircraft Operations” of the AEDT User Manual<sup>1</sup>). The APU Emissions Event Result is computed by the APU Emissions Processor, and stored into the database by the BLL Module.

The emissions modeling of the GSE associated with aircraft operations, so called GSE LTO, is activated by choosing specific equipment on the “Choose GSE/APU” step, and by specifying GSE parameters (Duration, Horsepower, Load Factor, and Manufacture Year) on the “Provide GSE Details” dialog of the “Create Aircraft Operation wizard” (refer to Section 6.2.1 “Create Single or Multiple Aircraft Operations” of the AEDT User Manual<sup>1</sup>). The GSE LTO Emissions Event Result is computed by the GSE LTO Emissions Processor and stored into the database by the BLL Module.

AEDT allows the user to assign a gate/terminal to the aircraft operation (refer to Section 6.2.1.3 Step 3: Choose Gate of the AEDT User Manual<sup>1</sup>).



The emissions modeling of the GSE, so called GSE population (which is not associated with aircraft operations), is activated by creating a new non-aircraft operation (refer to Section 6.3 “Non-Aircraft Operation” of the AEDT User Manual<sup>1</sup>). In the “Choose Equipment” step, the user selects a specific GSE equipment. In the “Provide GSE Details” step, the user provides the GSE characteristics (number of units, Horsepower, load factor, and manufacture year), and defines the gate distribution. In the “Assign Operational Profiles” step, the user chooses the appropriate operational profiles, which represent the quarter-hourly/daily/monthly distribution of the GSE operation during the modeling period. The user defines the modeling period by specifying the operation’s first day and last day when combining the GSE operations in a new operation group during the creation of a new Annualization (refer to Section 6.7 “Annualization” of the AEDT User Manual<sup>1</sup>). The GSE Population Emissions Event Result is computed by the GSE Population Emissions Processor and stored into the database by the BLL Module.

AEDT retrieves the Startup-, APU-, and GSE-related Emissions Event Results from the database, and for each gate object, accumulates the emissions from different sources for each hour bin. The total emissions are converted into the hourly emissions rates, which are reported to AERMOD through the HRE file. The Gate AEDT sources are modeled as VOLUME sources in AERMOD, and the total emissions are converted into the units of grams per second:

$$E_V(g, t) = \frac{1}{3600} \sum_{t,g} E_s \quad \text{Eq. 6-15}$$

where

$E_V(g, t)$  is a pollutant hourly emissions rate; for a given VOLUME gate object,  $G$ , and a given hour bin;

$t = 1, 2, \dots, 24$ ;

3,600 number of seconds in an hour; and

the emissions in grams,  $E_s$ , from various sources,  $s = \{\text{Startup, APU, GSE}\}$ , which are assigned to the same gate,  $g$ , and share the same hour bin,  $t$ , are accumulated.

The Terminal AEDT sources are modeled as AREAPOLY sources in AERMOD, and the total hourly emissions are converted into the units of grams per second per square meter:

$$E_A(g, t) = \frac{1}{3600} \frac{1}{A} \sum_{t,g} E_s \quad \text{Eq. 6-16}$$

where  $E_A(g, t)$  is a pollutant hourly emissions rate for a given polygonal AREAPOLY gate object,  $g$ , and  $A$  is the area of the polygon in square meters.

## 6.7 Emissions from Stationary Sources

To model emissions dispersion from stationary sources, the user needs to create an Emissions Dispersion metric result which includes one or more operation groups consisting of stationary operations only. Each stationary operation references either a system or a user-defined stationary source. In AEDT, training fires are treated as one of the stationary source categories.

The user can create a new user-defined stationary source using the copy feature of the non-aircraft pane of the Equipment tab. A new stationary source can be imported as a partial ASIF. In addition, if the AEDT study is created by means of the EDMS to ASIF Converter, all the user-defined stationary sources in the EDMS study will be transformed into the AEDT’s user-defined stationary sources. This section

focuses on the aspects of these processes which are essential for the emissions dispersion modeling of the stationary sources.

When creating a user-defined stationary source, the user specifies the following major characteristics:

- The AERMOD type of the source, which could be set to POINT, VOLUME, or AREAPOLY.
- For the POINT source, define the source temperature, diameter, and exhaust velocity. Note that an option to specify the temperature as an offset to the ambient temperature is not implemented in the current release of AEDT.
- For the VOLUME sources, define initial vertical and horizontal dispersion dimensions.
- For the AREAPOLY sources, define the initial vertical dispersion dimension, and the shape of the polygonal area as highlighted in Figure 6-5.
- Regardless of the AERMOD source type, the user specifies the release height of the source, and the required emissions characteristics, refer to Figure 6-5.

**Boiler/Space Heater - Type 87 SAMPLE**
User-defined

Name:	<input type="text" value="Boiler/Space Heater - Type 87 SAMPLE"/>
Category:	Boiler/Space Heater
Subcategory:	Natural Gas: Tangential Fired Boiler, Uncontrolled
(Operation) units:	1000s of m <sup>3</sup>
Source type:	<input type="text" value="Point-Vertical"/>

**Equipment Specifications**

Release height AGL (m):	<input type="text" value="20"/>
Exhaust velocity (m/sec):	<input type="text" value="15"/>
Exhaust Temperature (°F):	<input type="text" value="400"/>
Temperature above ambient:	<input type="checkbox"/>
Diameter (m):	<input type="text" value="1"/>

**Emission Indices**

CO emission index (kg/1000s of m <sup>3</sup> ):	<input type="text" value="0.3844431216"/>
NOx emission index (kg/1000s of m <sup>3</sup> ):	<input type="text" value="2.723138778"/>
PM10 emission index (kg/1000s of m <sup>3</sup> ):	<input type="text" value="0.030435079709"/>
PM10 emission index const term (kg/1000s of m <sup>3</sup> ):	<input type="text" value="Enter double"/>
PM10 emission index sulfur term (kg/1000s of m <sup>3</sup> - %Sulfur):	<input type="text" value="Enter double"/>
SOx emission index sulfur term (kg/1000s of m <sup>3</sup> - %Sulfur):	<input type="text" value="0.00961107804"/>
THC emission index (kg/1000s of m <sup>3</sup> ):	<input type="text" value="Enter double"/>
TNMOC emission index (kg/1000s of m <sup>3</sup> ):	<input type="text" value="Enter double"/>
TOC emission index (kg/1000s of m <sup>3</sup> ):	<input type="text" value="0.1762030974"/>
VOC emission index (kg/1000s of m <sup>3</sup> ):	<input type="text" value="0.0881015487"/>
CH4 emission index (kg/1000s of m <sup>3</sup> ):	<input type="text" value="0.00038"/>
CO2 emission index (kg/1000s of m <sup>3</sup> ):	<input type="text" value="36842.49633"/>

**Other Emission Parameters**

Fuel ash content (0-100%):	<input type="text" value="Enter double"/>
Fuel sulfur content (0-100%):	<input type="text" value="Enter double"/>
PM2.5 to PM10 ratio (0-1):	<input type="text" value="1"/>

**Pollution Control Factors**

Figure 6-5 Creation of a New User-Defined Stationary Source

In order to be modeled by AEDT, a stationary source should be referenced by a non-aircraft operation. When creating a new operation, the user sets the location, elevation, and annual throughput/consumption of the stationary operation. Note that for an AREAPOLY stationary source, the user defines the location of the first point of its shape, Point #0 in Figure 6-5. In addition, the user chooses the appropriate operational profiles, which represent the quarter-hourly/daily/monthly distribution of the operation during the modeling period. The user defines the modeling period by

specifying the operation's first day and last day when combining the stationary operations in a new operation group during the creation of a new annualization.

Hourly emissions, E, in unit of grams, are calculated by the AEDT's stationary sources emissions processor which implements the algorithms described in Section 2.6. "Stationary Sources and Training Fires" of the EDMS Technical Manual<sup>52</sup>, and in Section 5.2.3 GSE Data Sources of this document. The hourly emissions values and the major characteristic of the stationary sources are stored in the database within the stationary Emissions Event Results.

AEDT retrieves the stationary Emissions Event Results from the database and converts the hourly emissions into the hourly emissions rates, which are reported to AERMOD through the HRE file. For the stationary sources modeled as AREAPOLY sources, similar to , the hourly emissions, E, are divided by the number of seconds in an hour, and by the source's area, to convert them into units of grams per second per square meter. For stationary sources modeled as POINT or VOLUME sources, the hourly emissions, E, are divided by the number of seconds in an hour only to convert them to grams per second.

## 6.8 Emissions from Roadways, Parking Facilities, and Construction Sources

AEDT models roadways in AERMOD as one or more AREA sources (Table 6-1). One AREAPOLY source is constructed for every level of every parking facility, except for those that have zero annual vehicular throughput, which are ignored and not constructed. AEDT relies on the user to calculate the emissions and create AERMOD INP and HRE files for roadways, parking facilities, and construction sources, which are then input into AEDT processing. For regulatory purposes, MOVES should be used. Refer to the "AEDT Supplemental Manual: Using MOVES with AEDT"<sup>51</sup> on the AEDT Support website for additional information.

## 6.9 Applying Background Concentrations

AEDT allows the user to specify background concentrations as part of the metric results definition to incorporate into AERMOD calculations. One form of the background concentration can be specified for each metric result definition, which consists of a pollutant, an emission/receptor set, and an annualization.

When applying background concentrations, the user specifies the following characteristics:

- The number and bounds of any wind sectors;
- The units of the background concentration;
- If selected, an hourly file name containing background concentration values; and/or
- If selected, an annual value or a non-hourly file containing a string of background concentration values.

In an annual value is not provided, AEDT relies on the user to determine background concentration values and organize them into either an hourly input file or a non-hourly file with a string of values. AEDT parses this file and determines the appropriate AERMOD background flag (BGFLAG; refer to the AERMOD User's Guide for more information) keyword to use in the INP file based on the number of values given. Refer to the "AEDT Supplemental Manual: Background Concentrations in AEDT"<sup>53</sup> on the AEDT Support website for additional information.

### 6.9.1 Hourly Background Concentrations File

An hourly background concentration file is a comma or space-delimited file that gives a background concentration value for each hour of the study period. Each line of the file must give the year, month, day, hour, and background concentration for that hour. The hourly file should cover the entire study period, with no gaps. Specifying a -99 as the background concentration value indicates to AERMOD that the background concentration value is unknown, and AERMOD will attempt to use the non-hourly value for that hour instead, if provided. Figure 6-6 below provides an example hourly background concentration file.

```
2010,01,01,01,0.5
2010,01,01,02,0.5
2010,01,01,03,0.6
2010,01,01,04,0.6
2010,01,01,05,0.7
...
```

Figure 6-6 Hourly Background Concentration File Example

AEDT accepts a file name for an hourly input file as part of the metric result creation process. After specifying the file, AEDT will store the contents of the file in the Study database. When it is time to run AERMOD, AEDT re-creates the hourly input file in the output files directory for the metric result. The re-created file will be named *hourly\_bg.csv* if only one wind sector is specified, or *hourly\_bg\_#.csv* if multiple wind sectors are specified, where # is the number of the wind sector.

### 6.9.2 Non-Hourly Background Concentrations File

A non-hourly background concentration file is a simple text file used to specify background concentrations for temporal periods other than hourly. This file should provide a specific number of background concentration values to allow AEDT to define background concentrations for a specific period. For example, specifying four background concentration values is a seasonal definition – one for each season. The AERMOD accepted periods are listed below. The parameter *n* gives the total number of values expected in the file for AEDT to define the form of the background concentration correctly.

- ANNUAL – annual background value (n=1);
- SEASON - background values vary seasonally [Winter (Dec., Jan., Feb.), Spring (Mar., Apr., May), Summer (Jun., Jul., Aug.), and Fall (Sep., Oct., Nov.)] (n=4);
- MONTH - background values vary monthly (n=12);
- HROFDY - background values vary by hour-of-day (n=24);
- WSPEED - background values vary by wind speed (n=6);
- SEASHR - background values vary by season and hour-of-day (n=96);
- HRDOW - background values vary by hour-of-day, and day-of-week [M-F, Sat, Sun] (n=72);
- HRDOW7 - background values vary by hour-of-day, and the seven days of the week [M, Tu, W, Th, F, Sat, Sun] (n=168);

- SHRDOW - background values vary by season, hour-of-day, and day-of-week [M-F, Sat, Sun] (n=288);
- SHRDOW7 - background values vary by season, hour-of-day, and the seven days of the week [M, Tu, W, Th, F, Sat, Sun] (n=672);
- MHRDOW - background values vary by month, hour-of-day, and day-of-week [M-F, Sat, Sun] (n=864); and
- MHRDOW7 - background values vary by month, hour-of-day, and the seven days of the week [M, Tu, W, Th, F, Sat, Sun] (n=2,016).

The non-hourly file can be a single line of comma or space-delimited values, or each value can be on a separate line. The file should contain nothing but a set of background concentration values. AEDT will determine the time period based on the number of values provided and report it to the user under the file name as a TYPE.

### 6.9.3 Outputs of Background Concentrations

If background concentrations are applied, AEDT will invoke AERMOD such that background concentrations are included in the ALL source group. The output files will vary based on whether or not background concentrations are enabled:

- If background concentrations are enabled, these files will be generated:
  - PLT files with the tag WITHBACK will be generated for each selected averaging period. This file contains results for the ALL source group including background concentrations.
  - CON files with the tag BACK will be generated for each selected averaging period. This file contains concentration values for only the background concentrations across all receptor points and hours of the metric result.
- If background concentrations are not enabled, these files will be generated:
  - PLT files with the tag NOBACK will be generated for each selected averaging period. This file contains results for the ALL source group, and does not contain background concentrations.

Reported concentrations in the AEDT user interface will display the total pollutant concentration, as well as the portion of that concentration contributed by emissions sources and results for the ALL group in two different forms - with background concentrations and without background concentration. Results for the ALL source group without background concentrations will be calculated by taking the total pollutant concentrations from the WITHBACK PLT file, locating the corresponding background concentration entry in the CON file (taking into account both the same location and the same date/time), and subtracting the effect of the background concentration from the total concentration at that receptor point and time combination. In addition, background concentrations only will be reported separately.

## 6.10 NO<sub>2</sub> Dispersion Modeling

AEDT supports EPA's three-tiered and the non-regulatory ALPHA and BETA options for conversion of NO<sub>x</sub> to NO<sub>2</sub>:

- Tier 1 (Full conversion of NO<sub>x</sub> into NO<sub>2</sub>);
- Tier 2 (ARM2 = Ambient Ratio Method 2);
- Tier 3 (OLM = Ozone Limiting Method);
- Tier 3 (PVMRM = Plume Volume Molar Ratio Method);
- Non-regulatory ALPHA (TTRM = Travel Time Reaction Method);
- Non-regulatory ALPHA (TTRM2 = Travel Time Reaction Method 2); and
- Non-regulatory BETA (GRSM = Generic Reaction Set Method).

Each NO<sub>x</sub> conversion tier has a unique set of required input parameters.

### 6.10.1 Tier 1

This option assumes that all NO<sub>x</sub> is converted into NO<sub>2</sub>. No additional parameters are required.

### 6.10.2 Tier 2 (ARM2)

ARM2, the Ambient Ratio Method Version 2, adjusts the modeled NO<sub>x</sub> concentrations based on an empirical relationship between ambient NO<sub>2</sub> and ambient NO<sub>x</sub> concentrations<sup>xxxvi</sup>. This method requires two parameters: minimum and maximum NO<sub>2</sub>/NO<sub>x</sub> ratios. The ARM2 option applies an ambient ratio to the 1-hr modeled NO<sub>x</sub> concentrations based on a formula derived empirically from ambient monitored ratios of NO<sub>2</sub>/NO<sub>x</sub>. These two parameters are specified in the main AERMOD input file (AERMOD.INP) on the CO pathway as follows:

```
MODELOPT   CONC   DFAULT  ARM2
ARMRATIO   0.5   0.9
```

where the first number following the ARMRATIO keyword is the minimum ambient ratio, and the second number is the maximum ambient ratio. When the regulatory DFAULT secondary keyword is included on the CO MODELOPT card, as is the case with AEDT's support for this option, the ratios input must be between 0.5 and 0.9 with the first value (minimum ratio) being smaller than the second.

### 6.10.3 Tier 3 (OLM and PVMRM), Non-Regulatory ALPHA (TTRM/TTRM2), and BETA (GRSM) Options

Tier 3 (OLM or PVMRM), ALPHA options (TTRM/TTRM2) and BETA option (GRSM) require in-stack NO<sub>2</sub>/NO<sub>x</sub> ratios for each source and ozone background concentrations for conversion of NO to NO<sub>2</sub>. In addition, GRSM requires specification of background NO<sub>x</sub> concentrations.

<sup>xxxvi</sup> Refer to [Ambient Ratio Method Version 2 \(ARM2\) for use with AERMOD for 1-hr NO2 Modeling - Development and Evaluation Report \(09-20-2013\)](https://www.epa.gov/scram/air-quality-dispersion-modeling-preferred-and-recommended-models) on <https://www.epa.gov/scram/air-quality-dispersion-modeling-preferred-and-recommended-models>

Travel Time Reaction Method (TTRM) computes the conversion of NO to NO<sub>2</sub> based on reaction with ozone and limitations of the travel time from source to receptor.

Travel Time Reaction Method 2 (TTRM2) applies the existing TTRM method with one of ARM2, OLM, or PVMRM and will select the lowest NO<sub>2</sub> concentration from TTRM and the other selected NO<sub>2</sub> conversion technique.

General Reaction Set Method (GRSM) computes the conversion of NO to NO<sub>2</sub> based on equilibrium chemistry between NO, NO<sub>2</sub>, and the reaction with ozone.

### 6.10.3.1 In-Stack Ratios

The in-stack NO<sub>2</sub>/NO<sub>x</sub> ratio can be specified by using either CO NO2STACK to specify a default value to be used for all sources, or by using SO NO2RATIO to specify the value to be used at the source category level (this overrides the value specified by CO NO2STACK). In AEDT, a default value is provided, and the user is able to set unique values for each source in the GUI. In-stack ratios must be between 0.1 and 1.0, inclusive.

#### 6.10.3.1.1 Aircraft Thrust Specific In-Stack NO<sub>2</sub>/NO<sub>x</sub> Ratios

AEDT uses in-stack NO<sub>2</sub>/NO<sub>x</sub> ratios that correspond to specific aircraft thrust settings. The motivation for this approach comes from two sources:

- Gas Turbine Engine Emissions—Part I: Volatile Organic Compounds and Nitrogen Oxides (Timko et al., Journal of Engineering for Gas Turbines and Power 132(6), June 2010) (see Figure 6-6); and
- Development of a NO<sub>x</sub> Chemistry Module for EDMS/AEDT to Predict NO<sub>2</sub> Concentrations (M. Kenney, ACRP Project 02-43, December 2016) (see Figure 6-7).

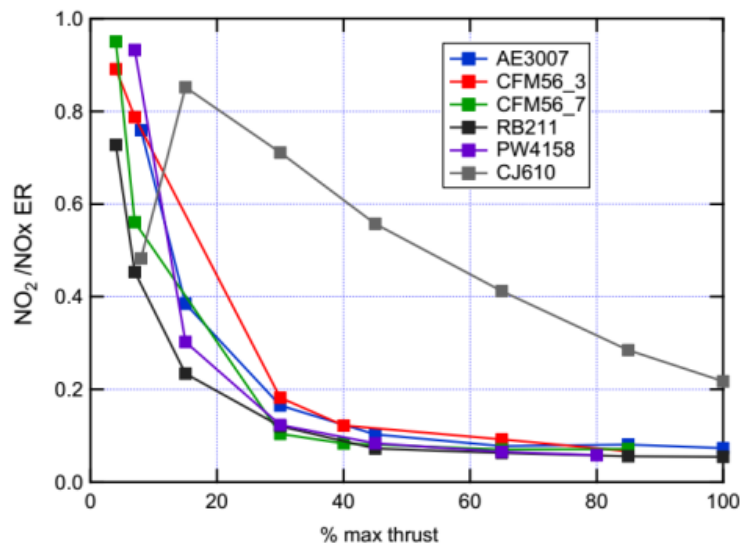

Figure 6-7 NO<sub>2</sub>/NO<sub>x</sub> Ratios for Jet Engines from Timko et. al



Source	NO <sub>2</sub> /NO <sub>x</sub> Ratio
Aircraft - Approach	~0.16
- Idle	0.6 to 0.98
- Takeoff	~0.08
- Climbout	~0.09
APUs	0.25 to 0.55
Gasoline Vehicles	0.01 to 0.05
Diesel Vehicles	0.05 to 0.20
(with DPM)	0.15 to 0.80
GSE (Gasoline)	0.05
(Diesel)	0.05 to 0.90
Stationary Engines (Diesel)	0.06
(CNG)	0.13

Figure 6-8 In-Stack Ratios from the ACRP Project 02-43

From these sources, default thrust-specific NO<sub>2</sub>/NO<sub>x</sub> ratios are included with AEDT as follows:

- Thrust Range 1 ( ≤ 10% thrust ): 1;
- Thrust Range 2 ( > 10% and ≤ 20% thrust ): 0.25;
- Thrust Range 3 ( > 20% and ≤ 50% thrust ): 0.15; and
- Thrust Range 4 ( > 50% thrust ): 0.1.

AEDT represents aircraft sources as voxel grids for purposes of emissions dispersion modeling, which is at a finer scale than aircraft operating mode. In-stack NO<sub>2</sub>/NO<sub>x</sub> ratios are defined within each voxel based on the thrust setting (thrust/max thrust ratio) calculated for the performance segment. When max thrust data is not available for an aircraft, AEDT uses the trajectory mode of a segment instead to set the in-stack NO<sub>2</sub>/NO<sub>x</sub> ratio.

For NO<sub>2</sub> modeling requiring in-stack NO<sub>2</sub>/NO<sub>x</sub> ratios (i.e., Tier 3 OLM, Tier 3 PVMRM, ALPHA TTRM/TTRM2, and BETA GRSM), AEDT uses the different thrust setting ranges listed above to assign different source IDs to voxels with multiple in NO<sub>2</sub>/NO<sub>x</sub> ratios. AEDT maps each thrust setting to one of the four source ID groups, which is written to the AERMOD.INP file as: CU1xxxxx, CU2xxxxx, CU3xxxxx, and CU4xxxxx – where xxxxx are zero-filled integers.

Default in-stack NO<sub>2</sub>/NO<sub>x</sub> ratios for aircraft thrust setting ranges are stored in the InStackRatioByThrustDefault table. Users have the option to modify the in-stack NO<sub>2</sub>/NO<sub>x</sub> ratios and thrust ranges when creating an NO<sub>2</sub> metric result in the AEDT GUI.

### *Thrust Setting Calculations for Fixed-Wing Aircraft*

For fixed-wing aircraft, thrust setting (percentage of rated thrust; Thrust/Max Thrust \* 100) for each segment is calculated using the corrected net thrust of the segment and Max Thrust.

- For jet engines, the RATED\_OUT column value (in kN) in the FLT\_ENGINES table is used as Max Thrust.
- For turboprops, the value is Shaft-Horse-Power (SHP) which is not a thrust. To convert to thrust, the THR\_STATIC column value (in lbf) in the FLT\_ANP\_AIRPLANES table is used.

In the AEDT Fleet database, the FLT\_ENGINES table, RATED\_OUT column (in kN) and the FLT\_ANP\_AIRPLANES table, THR\_STATIC column (in lbf) are identical for jet airplanes when compared using the same unit of measurement.

Table 6-2 ICAO Standard LTO Cycle and Thrust Settings

<b>ICAO Operating Mode</b>	<b>Thrust Setting (percentage of rated thrust)</b>
Approach	30%
Taxi and ground idle	7%
Take-off	100%
Climb	85%

### *Thrust Setting Calculations for Helicopters*

For helicopters, operation mode is used to determine thrust settings:

- 30% for arrival operations; and
- 85% for departure operations.

#### **6.10.3.2 Ozone Background Concentrations**

AEDT allows users to specify background ozone concentrations as part of the NO<sub>2</sub> metric results definition for the Tier 3 and non-regulatory ALPHA and BETA options.

When applying ozone background concentrations, the user specifies the following characteristics:

- Whether to remove the minimum ozone restriction (NOMINO3);
- The number and bounds of any wind sectors;
- The bounds of the wind speed categories, if applicable;
- The units of the background concentrations;
- An hourly file name containing background concentration values; and/or
- A non-hourly file containing a string of background concentration values.

Ozone options are specified in the CO pathway of the AERMOD.INP file. AEDT relies on the user to determine ozone background concentration values and organize them into either an hourly input file or a non-hourly file with a string of values. AEDT parses this file and determines the appropriate O3Flag.

#### 6.10.3.2.1 Ozone Hourly Background Concentrations File

An hourly background concentration file is a comma or space-delimited file that gives a background concentration value for each hour of the study period. Each line of the file must give the year, month, day, hour, and background concentration for that hour. The hourly file should cover the entire study period, with no gaps. Specifying a -99 as the background concentration value indicates to AERMOD that the background concentration value is unknown; and AERMOD will attempt to use the non-hourly value for that hour instead, if provided. Note that the unit of measurement for the ozone concentrations is specified in AERMOD.INP file in the CO pathway where the last item specifies the unit (UGM3, PPB, or PPM):

```
OZONEFIL 06-073-1010HourlyOzoneFile2015.txt PPM
```

The following is a sample hourly background concentration file.

```
2010,01,01,01,0.5
2010,01,01,02,0.5
2010,01,01,03,0.6
2010,01,01,04,0.6
2010,01,01,05,0.7
...
```

AEDT accepts a file name for an hourly background concentration file when creating an NO<sub>2</sub> metric result. After specifying the file, AEDT stores the contents of the file in the study database. When the NO<sub>2</sub> metric result is run, AEDT re-creates the hourly input file in the study output folder. The re-created file is either named *hourly\_bg.csv* if only one wind sector is specified, or *hourly\_bg\_#.csv* if multiple wind sectors are specified, where # is the number of the wind sector.

#### 6.10.3.2.2 Ozone Non-Hourly Background Concentrations File

A non-hourly background concentration file is a text file used to specify ozone background concentrations for temporal resolutions other than hourly. This file is used to provide a discrete number of background concentration values in order to define ozone background concentrations for a specific period. For example, specifying four background concentration values is used to define seasonal background concentrations – one for each season. The allowable background concentration temporal resolutions are listed below. The parameter *n* gives the total number of values expected in the file for AEDT to define the form of the background concentration correctly.

- ANNUAL – annual background value (n=1);
- SEASON – background values vary seasonally [Winter (Dec., Jan., Feb.), Spring (Mar., Apr., May), Summer (Jun., Jul., Aug.), and Fall (Sep., Oct., Nov.)] (n=4);
- MONTH – background values vary monthly (n=12);
- HROFDY – background values vary by hour-of-day (n=24);
- WSPEED – background values vary by wind speed (n=6);
- SEASHR – background values vary by season and hour-of-day (n=96);

- HRDOW – background values vary by hour-of-day, and day-of-week [M-F, Sat, Sun] (n=72);
- HRDOW7 – background values vary by hour-of-day, and the seven days of the week [M, Tu, W, Th, F, Sat, Sun] (n=168);
- SHRDOW – background values vary by season, hour-of-day, and day-of-week [M-F, Sat, Sun] (n=288);
- SHRDOW7 – background values vary by season, hour-of-day, and the seven days of the week [M, Tu, W, Th, F, Sat, Sun] (n=672);
- MHRDOW – background values vary by month, hour-of-day, and day-of-week [M-F, Sat, Sun] (n=864); and
- MHRDOW7 – background values vary by month, hour-of-day, and the seven days of the week [M, Tu, W, Th, F, Sat, Sun] (n=2,016).

In AERMOD, these temporal resolutions (or secondary keywords) are referred to as the O3Flag parameter. Refer to the AERMOD User's Guide for more information about the O3Flag parameters.

The non-hourly file can be a single line of comma- or space-delimited values, or each value can be on a separate line. The file should only contain a set of background concentration values. AEDT will determine the temporal resolution based on the number of values provided and report it to the user under the file name as a TYPE.

#### 6.10.3.2.3 Outputs of Ozone Background Concentrations

AEDT will invoke AERMOD with the ozone background concentrations in the CO pathway of the AERMOD.INP file.

#### 6.10.3.3 *NO<sub>x</sub> Background Concentrations*

For the GRSM (BETA) option only, AEDT allows the user to specify background NO<sub>x</sub> concentrations as part of the NO<sub>2</sub> metric result. The general specification of wind sectors and background concentrations is identical to that used for specifying ozone background concentrations (described in the previous section) with the exception of several keywords – NOXSECTR instead of O3SECTOR, NOX\_VALS instead of O3VALUES, NOX\_FILE instead of OZONEFIL, and NOX\_UNIT instead of OZONUNIT.

AEDT will invoke AERMOD with the NO<sub>x</sub> background concentrations in the CO pathway of the AERMOD.INP file.

### 6.11 Non-NAAQS PM<sub>2.5</sub> Dispersion Option

Beginning with AEDT 3f, users can model PM<sub>2.5</sub> dispersion on a sub-annual basis and output results for averaging times other than 24-hour and annual. To access these additional modeling options when modeling PM<sub>2.5</sub>, the user checks the box next to “Allow computation of all averaging times without EPA's PM<sub>2.5</sub> modeling requirements” within the Set Processing Options screen of the Define Metric Results wizard. When this option is selected, AEDT will include the 'INC' keyword on the POLLUTID line in the CO pathway of the AERMOD.INP file. This disables the special processing requirements associated with the 24-hour PM<sub>2.5</sub> NAAQS. The CO pathway section of a sample AERMOD.INP file is presented below, which

shows that the non-NAAQS option has been selected along with different averaging times besides 24 hour.

```
CO STARTING
  TITLEONE Example PM2.5 NonNAAQS Study
  TITLETWO User; Version [AEDT 3f]; Time
  MODELOPT CONC DFAULT
  AVERTIME 1 12 24
  POLLUTID PM25 INC
  FLAGPOLE 1.8
  RUNORNOT RUN
  SAVEFILE
CO FINISHED
```

If a user selects an annualization with less than a full year of operations, the non-NAAQS option will be enabled by default and the user will not be able to disable the option. This is because modeling PM<sub>2.5</sub> with less than a full year of operations (and thus, less than a full year of meteorology) violates one of EPA's restrictions for modeling PM<sub>2.5</sub> when the special processing requirements is enabled (i.e., when 'INC' keyword is omitted from POLLUTID line). If a user selects an annualization with a full year of operations, users will have the option to enable the non-NAAQS option or not. As with earlier versions of AEDT, when the non-NAAQS option is disabled, only 24-hour and annual averaging periods are available for modeling.

## 6.12 Urban Modeling Option

If the Urban Modeling Option is enabled by the user (with a population size provided), the urban area population is defined using the URBANOPT keyword on the CO pathway in the INP file. The sources that are to be modeled incorporating urban effects and the urban area that will be applied to each source are identified using the URBANSRC keyword on the SO pathway. The keywords and syntax used are summarized below:

```
CO URBANOPT UrbPop (UrbName) (UrbRoughness)
SO URBANSRC ALL (to specify all sources as URBAN)
```

where the *UrbPop* parameter specifies the population of the urban area, the optional *UrbName* parameter may be used to identify the name of the urban area, and the optional *UrbRoughness* parameter may be used to specify the urban surface roughness length.

AEDT uses the AERMOD default for the optional parameter *UrbRoughness* and omits the *UrbName* optional parameter. If the user enables the Urban Modeling option and enters an urban population greater than 0 when creating a metric result, the following modifications will be triggered in the AERMOD.INP file:

- CO pathway: addition of "URBANOPT UrbPop" (e.g. URBANOPT 320000); and
- SO pathway: addition of "SO URBANSRC ALL".

### 6.13 Low Wind Options (ALPHA)

AEDT allows the user to enable and use the AERMOD LOW\_WIND ALPHA option for evaluation of the model under low wind speed conditions. Enabling the Low Wind Option will replace the secondary keyword 'DFAULT' with 'ALPHA' for the CO MODELOPT input and will override the default low wind parameters with user-defined values.

User-defined values can be specified for one or more of the low-wind parameters:

- Minimum sigma-v value (SVmin) within a range of 0.01 to 1.0 m/s, default 0.2 m/s;
- Minimum wind speed value (Wsmn) within a range of 0.01 to 1.0 m/s, default 0.2828 m/s;
- Minimum value for the meander factor (FRANmin), within a range of 0.0 to 1.0, default 0;
- Maximum value for the meander factor (FRANmax), within a range of 0.0 to 1.0, default 1.0;
- Minimum sigma-w value (SWMin), within a range of 0.0 to 3.0 m/s, default 0.02 m/s;
- Time period (BigT) used to calculate the time scale TRAN, within a range of 0.5 to 48.0 hours, default 24 hours; and
- Alternate momentum balance (PBAL) approach to determine plume meander which overrides the default energy balance approach.

If the user enables the Low Wind Option, all seven parameters will be written to the AERMOD.INP file. Any parameters not modified by the user will be written to the AERMOD.INP file as the default values for those parameters.

### 6.14 Plume Rise for Aircraft Sources Option (ALPHA)

AEDT allows users to access a new plume rise ALPHA option for aircraft sources in AERMOD 23132, that can be enabled by checking the appropriate box in the define metric result wizard. Please refer to Section 13.3 Plume Rise Modeling Option for additional details.

### 6.15 Area Meander Option (ALPHA)

Plume meander is the slow lateral back and forth shifting of the plume from low frequency, non-diffusing eddies as the plumes travels downwind. Prior to AERMOD 23132, plume meander was already accounted for when modeling POINT or VOLUME sources. With the latest release, the plume meander algorithm has been made available for AREA sources as well, as an ALPHA option.

AEDT allows the user to use enable the Area Meander Option (AREAMNDR) to apply plume meander algorithms to AREA source types. This option is not aircraft specific, and will apply to any AREA source in the model run.

### 6.16 AERMET Weather Processing

#### 6.16.1 Overview

When conducting air quality dispersion modeling in AEDT, meteorological data must be processed with EPA's AERMET<sup>54</sup> prior to running AERMOD. AERMET is a general-purpose meteorological preprocessor

---

for organizing meteorological data into a format suitable for use by AERMOD. AEDT has an embedded version of AERMET that provides an interface to processing various types of weather data formats. Section 6.16.2 describes the supported weather data formats by AERMET. AERMET requires National Weather Service (NWS) hourly surface observation data and NWS twice-daily upper air soundings. AERMET is also capable of processing data from a site-specific meteorological measurement program.

AERMET processes the surface and upper air sounding data in two stages. The first stage extracts meteorological data from archive data files and processes the data through various quality assessment checks. The second stage reads the processed meteorological data from Stage 1 then estimates the necessary boundary layer parameters for use by AERMOD.

AEDT generates input files for each of the AERMET stages – STAGE1SURF.INP, STAGE1UPPER.INP, and STAGE2.INP. All the files for AERMET processing files are saved to  $\${AEDT}\Temp\AERMET$  directory. Since AEDT saves all files used for AERMET processing in a single directory, users may modify INP files then rerun AERMET if desired.

AERMET creates the following output files:

- The AERMOD surface file which contains hourly boundary layer parameter estimates (.SFC file);
- The AERMOD profile file which contains multiple-level observations of wind speed and direction, temperature, and standard deviation of the fluctuating components of the wind (.PFL file);
- The intermediate AERMET surface observation file (SFQAFILE.MET); and
- The intermediate AERMET upper air file (UAQAFILE.MET).

The surface file (.SFC) and the profile file (.PFL) are used directly by AERMOD and contain only the meteorological parameters needed for dispersion purposes.

The AERMET surface observation file (SFQAFILE.MET) is an intermediate output file by AERMET and retains necessary meteorological parameters from the user-supplied surface data file that are needed to fly aircraft. It includes pressure, temperature, humidity, ceiling height and visibility. At the start of an emissions dispersion metric result, this file is read to directly drive the aircraft performance and runway configurations. If weather data for some hours are missing in this file, they are substituted with airport annual average weather for the year of the missing hour. If that is not available, then the 10-year average weather data for the airport is used. If no 10-year average weather data is available, ISA weather is used. Note that this weather data substitution is only applied to calculate the aircraft performance portion of dispersion modeling, and it is not applied to air quality dispersion modeling.

The AERMET upper air file (UAQAFILE.MET) is an intermediate output file by AERMET. This file is not used by AEDT at this time.

Hourly weather is never interpolated within hours. That is, the hourly weather is set to be the same for all minutes within the hour. This behavior is different from the case using high fidelity weather data where the weather is interpolated/extrapolated linearly in all dimensions (x, y, z, and time).

### 6.16.2 Accepted Weather Data Formats

Weather data sanctioned by EPA must be provided in one of the formats listed in Table 6-3. This may require converting the weather data into one of the formats listed. If weather for a specific location is not available, an appropriate substitution should be used.

Table 6-3 Accepted Weather Data Formats for Emissions Dispersion Modeling

File Format	Use	Description Source
TD-3505 (ISHD)	Surface	NOAA site: <a href="https://www.ncei.noaa.gov/data/global-hourly/archive/isd/">https://www.ncei.noaa.gov/data/global-hourly/archive/isd/</a> ; or NCAR Research Data Archive (world-wide data) <a href="https://rda.ucar.edu/datasets/ds463.3/">https://rda.ucar.edu/datasets/ds463.3/</a>
CD-144	Surface	NOAA National Centers for Environmental Information (NCEI)
HUSWO (Hourly Surface Weather Observations)	Surface	NOAA National Centers for Environmental Information (NCEI)
SCRAM (TD-1440)	Surface	EPA <a href="https://www.epa.gov/scram/air-quality-modeling-surface-and-upper-air-databases">https://www.epa.gov/scram/air-quality-modeling-surface-and-upper-air-databases</a>
SAMSON (Solar and Meteorological Surface Observation Network)	Surface	Data: <a href="http://www.webmet.com/met_data.html">http://www.webmet.com/met_data.html</a> Data Guide: <a href="http://www.webmet.com/MetGuide/Samson.html">http://www.webmet.com/MetGuide/Samson.html</a>
ASOS 1-minute (DSI-6405 format) wind data	Surface	ASOS, 1-minute/5-minute data are available from <a href="https://www.ncei.noaa.gov/products/land-based-station/automated-surface-weather-observing-systems">https://www.ncei.noaa.gov/products/land-based-station/automated-surface-weather-observing-systems</a>
ASOS 5-minute (DSI-6401 format) wind data	Surface	
Integrated Global Radiosonde Archive (IGRA)	Upper Air	NOAA <a href="https://www.ncei.noaa.gov/products/weather-balloon/integrated-global-radiosonde-archive">National Centers</a> for Environmental Information (NCEI), <a href="https://www.ncei.noaa.gov/products/weather-balloon/integrated-global-radiosonde-archive">https://www.ncei.noaa.gov/products/weather-balloon/integrated-global-radiosonde-archive</a>
TD-6201	Upper Air	Data: <a href="http://www.webmet.com/met_data.html">http://www.webmet.com/met_data.html</a> Data Guide: <a href="http://www.webmet.com/MetGuide/TD6200.html">http://www.webmet.com/MetGuide/TD6200.html</a>
Radiosonde Data of North America – FSL format	Upper Air	General Information: <a href="https://ruc.noaa.gov/raobs/General_Information.html">https://ruc.noaa.gov/raobs/General_Information.html</a> Data Download: <a href="https://ruc.noaa.gov/raobs/">https://ruc.noaa.gov/raobs/</a>

#### 6.16.2.1 Local Time and UTC Time Considerations

Weather files such as the Integrated Surface Hourly Data (ISHD) and Forecast Systems Laboratory (FSL) are based on UTC time, not local time. AERMET produces the weather files **in local time** if the time difference is given. For example, January 1<sup>st</sup> in East Coast Standard (US) time corresponds to Hour 5 of



January 1 in UTC. EDMS weather data processing drops the local - UTC time hour differences (the beginning and the end of the weather files); meaning that the SFC, PFL, and MET weather files are missing the last day weather data for the amount of the local - UTC difference for east meridian locations. AEDT keeps the same method for compatibility with EDMS. If the user wants to account for all hours of data from raw weather, AERMET must be used with the appropriate time for local minus UTC time differences. That is, in order to get local weather data files for a full year, the user must provide AERMET, for example, UTC January 1 to January 1 of the next year. This will generate local weather data from Hour 19 of December 31<sup>st</sup> to Hour 19 of January 1<sup>st</sup> of the next year. The user edits the beginning and the end of the weather file so that it is from the January 1<sup>st</sup> first hour to December 31<sup>st</sup> 24<sup>th</sup> hour. Note: AERMET hourly time convention is from 1 to 24 (i.e., first hour of the day to the 24<sup>th</sup> hour of the day), not 0 to 23.

#### 6.16.2.2 Note to Users Outside of the United States

In order to run dispersion, surface weather data is required in one of the following formats sanctioned by EPA: TD-3505 (ISHD), CD-144, HUSWO, SCRAM, SAMSON.

Surface weather data must be converted to one of those formats to be used in AEDT. In addition, an early morning upper-air sounding is required in either TD-6201, IGRA, or FSL format. Typically, these soundings occur at 00:00 GMT and 12:00 GMT, which does not provide a sounding at the necessary time for much of the globe. If an appropriate sounding is not available for your location, the Lakes Environmental Upper Air Estimator (available from [www.weblakes.com](http://www.weblakes.com)) may be appropriate. Specific guidance regarding the AERMET data requirements is provided in the AERMET User's Guide<sup>54</sup>.

#### 6.16.3 Modeling Low Wind Speed/Stable Conditions

AERMOD is a steady-state Gaussian dispersion model; therefore calm or very low wind speeds can result in artificially high concentration results without special treatment. AEDT supports the following meteorological refinements for handling low wind speed stable conditions.

- Apply a default ½ knot adjustment to truncated ASOS wind speeds;
- Surface friction velocity adjustment in AERMET (ADJ\_U\*); and
- Usage of hourly-average wind data from Automated Surface Observing Systems (ASOS) using AERMINUTE.

Wind speeds collected at ASOS sites are truncated rather than rounded to whole knots. This introduces a bias in the data toward lower wind speeds. To compensate, by default, AERMET adds ½ knot (0.26 m/s) to all ASOS-based wind speeds. If the user turns off this default adjustment, then AEDT will override the adjustment when running AERMET by adding the ASOS\_ADJ method and NO\_ADJ keyword to the AERMET Stage 2 METPREP pathway using the format: METHOD ASOS\_ADJ NO\_ADJ.

The ADJ\_U\* option is used to adjust the surface friction velocity (U\*) under low wind/stable condition. A sample STAGE2.INP file is displayed below when this option is used for AERMET processing.

```
JOB
MESSAGES STAG2MSG.TXT
```

```

REPORT    STAG2RPT.TXT
SURFACE
  QAOUT   SFQAFILE.MET
UPPERAIR
  QAOUT   UAQAFILE.MET
METPREP
METHOD    WIND_DIR  RANDOM
METHOD    STABLEBL ADJ_U*
METHOD    REFLEVEL SUBNWS
NWS_HGT   WIND 10
FREQ_SECT ANNUAL 1
SECTOR    1 0 360
SITE_CHAR 1 1 0.5 1 0.1
OUTPUT    Dulles.SFC
PROFILE   Dulles.PFL

```

The output Dulles.SFC file contains the following header indicating that this option was used:

```

38.950N 77.450W UA_ID: 93734 SF_ID: 93738 OS_ID:
VERSION: 23132 ADJ_U* CCVR_Sub TEMP_SubM

```

#### 6.16.4 Use of AERMINUTE

For dispersion modeling purposes, it is more appropriate to use hourly-average wind data that is representative of the wind throughout the hour of the observation compared to the standard NWS hourly weather observations that reflect the conditions at the time the observation was made. AERMINUTE calculates hourly-averaged wind data for input into AERMET based on 1-minute (and optionally 5-minute) ASOS wind data, and it also addresses the data gaps in the standard ASOS meteorological data<sup>55</sup>. As part of AERMINUTE processing, the IFW\_stat.csv<sup>xxxvii</sup> file is used to determine whether the weather station is part of the Ice Free Winds (IFW) group during the period denoted by the dates listed with STARTEND in AERMINUTE.INP. AERMINUTE produces a file named *\$(StationCode)HourlyAverage.txt* which is then used in the Stage2 of AERMET processing.

The THRESH\_1MIN option is used to limit the 1-minute ASOS wind speed. A sample STAGE2.INP file is displayed below when this option is used for AERMET processing.

```

JOB
  MESSAGES STAG2MSG.TXT
  REPORT    STAG2RPT.TXT
SURFACE
  ASOS1MIN IADHourlyAverage.txt
  QAOUT     SFQAFILE.MET

```

<sup>xxxvii</sup> This file is based on [https://www.weather.gov/media/asos/ASOS%20Implementation/IFW\\_stat.pdf](https://www.weather.gov/media/asos/ASOS%20Implementation/IFW_stat.pdf), dated October 27, 2009.

```
UPPERAIR
  QAOUT    UAQAFILE.MET
METPREP
  THRESH_1MIN 0.5
  METHOD      WIND_DIR RANDOM
  METHOD      STABLEBL ADJ_U*
  METHOD      REFLEVEL SUBNWS
  NWS_HGT    WIND 10
  FREQ_SECT  ANNUAL 1
  SECTOR     1 0 360
  SITE_CHAR  1 1 0.5 1 0.1
  OUTPUT     Dulles.SFC
  PROFILE    Dulles.PFL
```

This results in a Dulles.SFC file that contains the following header:

```
38.950N 77.450W UA_ID: 93734 SF_ID: 93738 OS_ID:
VERSION: 23132 THRESH_1MIN = 0.50 m/s; ADJ_U* CCVR_Sub TEMP_Sub
```

When the hourly average file is given, AERMET will replace the wind direction data completely and modify the wind speed data in the surface file (.SFC). For additional information, please refer to the AERMINUTE User's Guide<sup>56</sup>, Section 4.1.2.

### 6.16.5 AERSURFACE Integration with AEDT

This section describes AEDT's integration with the EPA AERSURFACE tool. Users can either provide an AERSURFACE output file or run the AERSURFACE tool directly in AEDT.

Using AERSURFACE generated output is available as an option for users who want to use surface characteristics produced by AERSURFACE when generating weather files for their dispersion analysis. Users may elect to use pre-prepared weather data or to run AERMET without running AERSURFACE.

#### 6.16.5.1 AERSURFACE Overview

The generation of weather files by AERMET needed for an AERMOD run requires providing surface characteristics such as albedo, Bowen Ratio, and surface roughness. AERSURFACE calculates these three variables based on the U.S. Geological Survey (USGS) National Land Cover Data (NLCD) and outputs them in a format for AERMET processing. AEDT can read an AERSURFACE output file generated by AERSURFACE versions 13016, 19039, and 20060.

#### 6.16.5.2 AERSURFACE Integration in the AEDT GUI

This section describes how AERSURFACE is integrated in AEDT and the input data for running AERSURFACE.

#### 6.16.5.2.1 AERSURFACE Executable Integration

AERSURFACE version 20060 is provided with the AEDT installer. AERSURFACE processing occurs in AEDT's temporary folder (e.g., C:\AEDT3g\Temp\AERSURFACE), and the resulting output files required for further processing are copied to the user's study output directory. This is similar to how AERMET and AERMOD processing is done in AEDT.

#### 6.16.5.2.2 Land Cover Data

The user is responsible for providing required land cover data in the GeoTIFF format. For dispersion runs in years more recent than 1992, users can add the impervious and canopy data to supplement the land cover data. By default, AEDT displays files with the extension .tif and .tiff, when prompted to select files.

- Publicly accessible more recent NLCD 2001, 2006, 2011, and 2016 land cover data are available as data catalog of statewide files as well as 3 x 3-degree TIFF files:  
<https://www.usgs.gov/centers/eros/science/national-land-cover-database>
- Similarly, statewide and 3 x 3 degree data files can be downloaded as TIFF files via the USGS National Map at the following link: <https://apps.nationalmap.gov/downloader/#/>

#### 6.16.5.2.3 Weather Station Location

The location of the weather station is a required input. AEDT automatically reads weather station location from a surface data file if is provided. The user can also manually enter latitude and longitude of a weather station.

#### 6.16.5.2.4 Temporal Resolution and Climate Parameters

The user can set temporal resolution with the options – ANNUAL, SEASONAL, and MONTHLY. The user can specify parameters associated with the CO CLIMATE keyword in AERSURFACE associated with surface moisture, continuous snow cover and arid conditions.

#### 6.16.5.2.5 Wind Direction Dependency

The user can define up to 12 contiguous non-overlapping wind sectors, where the surface characteristics are to be calculated.

### 6.17 Terrain Processing

When running an Emissions Dispersion metric result, AEDT will use regulatory terrain (assumed perfectly flat) by default. AEDT does not currently handle terrain for dispersion modeling.

### 6.18 Generating Hourly Emissions Files

When running an Emissions Dispersion metric result, AEDT will automatically generate hourly emissions (HRE) files for input into AERMOD. HRE files are generated for the following pollutants:

- CO (Carbon Monoxide);
- THC (Total Hydrocarbons) for aircraft and APUs only;
- NMHC (Non-Methane Hydrocarbons);

- VOC (Volatile Organic Compounds);
- TOG (Total Organic Compounds);
- NO<sub>x</sub> (Nitrogen Oxides);
  - NO<sub>2</sub> (Nitrogen Dioxide): derived from NO<sub>x</sub>
- SO<sub>x</sub> (Sulfur Oxides);
  - SO<sub>2</sub> (Sulfur Dioxide): derived from SO<sub>x</sub>. All SO<sub>x</sub> is converted into SO<sub>2</sub>.
- PM<sub>10</sub> (Particulate Matter, 10 microns or less); and
- PM<sub>2.5</sub> (Particulate Matter, 2.5 microns or less).

AEDT models CO<sub>2</sub> emissions, and the Emissions Event Results contain the respective emissions values. However, the AEDT does not model dispersion of CO<sub>2</sub> emissions because it is not a criteria pollutant and not required under NEPA.

### 6.19 Generating AERMOD Input Files (.INP and .HRE)

The AEDT emissions dispersion process consists of two steps:

1. Run the study to generate “event” results using the MET file; and
2. Run AERMOD by generating .INP and .HRE files from the results.

The INP file points to the hourly surface weather file (.SFC) and the upper air weather file (.PFL). For aircraft operations, “segment-level” results are needed. To produce the HRE file, event-level results are extracted from the Study database. The emissions related to startup, APU, and GSE are gathered as gate emissions. Stationary sources are gathered as point, areapoly, and volume emissions. Note that taxi emissions are gathered separately. Aircraft emissions are collected as grid emissions. After collecting all these emissions, the AERMOD.INP file is generated. AEDT does not generate runway-based labels for aircraft operations in the .INP file; instead, aircraft operations have labels with “CUB” prefix.

For a combined Metric Result (job) that includes two or more pollutants, the emissions event result generation step is performed only once and generates emissions event results encompassing all the pollutants. The second step of generating the HRE files is optimized by retrieving emissions results once from the database and subsequently generating the individual AERMOD input files sequentially. The retrieval step is substantially more time consuming than the second step of writing out the text AERMOD input files.

### 6.20 Running AERMOD

When running an emissions dispersion metric result, AEDT automatically invokes AERMOD to generate the dispersion results for each receptor once the AERMOD input files are generated. Because AERMOD is a single-threaded application, it can take a considerable time to produce a year’s worth of emissions dispersion results. However, for a Metric Result (job) that includes two or more pollutants, AEDT will run AERMOD simultaneously in parallel for as many pollutants as there are in the combined Metric Result.

Since AERMOD has a small memory and CPU footprint, this results in a substantial performance increase.

For single pollutant metric results, or for combined metric results with multiple pollutants, AEDT will produce all files necessary to run AERMOD in a single output directory by pollutant. For example, `C:\AEDT3g\DATA\[User name]\[Study name]@[SQL Server Instance Name]\Output_Files\CO_J5` directory is for the pollutant CO from Metric Result ID 5. Users can modify the AERMOD.INP in this directory and re-run AERMOD to get the desired output. For example, users can add CON outputs.

In addition to PLT files for the ALL source group, PLT files for each of the source groups in the AERMOD input file will be created. If background concentrations are enabled, the concentrations specified in those PLT files will also include background concentrations.

### 6.20.1 Emissions Dispersion Output Options

The following output options are set in the *Study* tab, *Preferences*, *Emissions Dispersion* screen.

- “Output CON file”: when this option is selected, raw pollutant concentration files, AERMOD’s POSTFILES, will be generated for each source group chosen by the user in the “Set Processing Options” dialog. POSTFILES will be generated for the same set of the source groups that are available for the emissions dispersion reports and pollutant concentration layers.

In addition, the POSTFILE’s will be generated for AIRB300M (aircraft sources below 300 meters) and AIRA300M (aircraft sources above 300 meters) source groups. Data from the POSTFILES are not stored in the AEDT study database. These data may be used to support more detailed analysis.

- “Create release height source groups”: when selected, AEDT will create source groups by release height within the AERMOD.INP file. The release heights for the additional source groups are as follows: 22, 42, 62, 82, 102, 122, ..., 302, 619.2 meters. The naming convention for the release height source groups is “AIR”, followed by the release height, e.g., airborne sources for a release height of 62 meters is named AIR062.
- “Split aircraft area sources by aircraft engine type”: this option is intended to be run with the “Create release height source groups” option, which should also be selected. When selected, AEDT will create source groups by aircraft engine type within the AERMOD.INP file. The subgroups are as follows:
  - Fixed Wing with Jet Engine (AFJ)
  - Fixed Wing with Turboprop Engine (AFT)
  - Fixed Wing with Piston Engine (AFP)
  - Helicopter with Turboprop Engine (AHT)
  - Helicopter with Piston Engine (AHP)

The naming convention for the aircraft engine type source groups will include the subgroup abbreviation. Also, the release height source group, or the “AIR” group, for each release height could be recreated by combining the applicable aircraft engine type subgroups. For example, the sum of results from AFJ302, AFT302, AFP302, AHT302, and AHP302 source groups would be equal to the AIR302 source group.

### 6.20.2 Exclusion Zones with Volume Sources

When using VOLUME sources for aircraft operations, at individual receptors AERMOD will exclude the contributions at that receptor from all sources of type VOLUME when the receptor is within the source’s *exclusion zone*. The exclusion zone (radius in meters) for VOLUME sources in AERMOD is defined as:

$$\text{Exclusion Zone} = (2.15 * \text{Initial Lateral Dispersion Dimension (in meters)}) + 1$$

AERMOD will generate a warning in the AERMOD.OUT file for each instance of an exclusion zone violation for any given receptor-source combination. The warning text is of the form “*SOURCE-RECEPTOR COMBINATIONS FOR WHICH CALCULATIONS MAY NOT BE PERFORMED*” and will list the source and the receptor coordinates (in x,y). AEDT reports all such exclusion zone violations to the aedt.log file by providing the source name and the receptor latitude/longitude coordinates. In addition, AEDT will display exclusion zone violation locations on the map when users generate a receptor set layer for a dispersion metric result with exclusion zone violations.

Note, receptors with one or more exclusion zone violations may still report non-zero concentrations as other VOLUME sources farther away than the exclusion zone radius will still contribute to the receptor; however, these concentrations may be an underestimate. It is up to the user to decide if an exclusion zone violation warrants shifting a receptor to be outside the exclusion zone or not.

## 7. Ground Operations

This section describes the multiple algorithms that combine to produce ground movements and emissions for aircraft operations. For the purposes of this section, ground movements refer to the sequenced movements performed by airplanes along the taxiway network. In AEDT, all helicopter taxi movements are from a heligate to a helipad (or vice versa). Helicopter taxi movements from a gate to a runway end (or vice versa) are not supported.

### 7.1 Operating Configurations

Operating configurations are used to more accurately model airport activities by preventing aircraft from erroneously landing and/or taking off with the wind direction. Each airport layout can be linked to a set of configurations. At least one configuration is required for an airport layout if that airport layout is exercised in a metric result for which sequence modeling is enabled. Airport configurations for a specific airport layout do not interact with those belonging to other airport layouts; therefore, dependencies between configurations of two different airport layouts within a given scenario cannot be modeled. The fidelity of the configuration modeling prevents accurate modeling of temporary configuration changes due to airport equipment outages or substantial precipitation (e.g., runway closure for snow removal) and is insensitive to air traffic control decisions.

Operating configurations are selected (or *activated*) based on hourly activation parameters values (i.e., wind speed, wind direction, hour of the day, ceiling, visibility and temperature). The hourly weather parameters from both hourly weather files (i.e., those necessary to run a dispersion analysis) and average airport weather are used to activate configurations for each hour of a metric result's timespan. For each hour in the timespan of a metric result, average airport weather is used whenever values from hourly weather files are not available. The active configuration can change only on the hour (with no more than 24 changes per day) due to the fact that hourly weather data is the highest temporal resolution available.

### 7.2 Configuration Activation Based on Activation Parameters

Operating configurations consist of the following six activation parameters:

- Wind Direction
- Wind Speed
- Hour-of-Day
- Cloud Ceiling
- Horizontal Visibility
- Temperature

For each hour, the configurations of an airport layout are evaluated, in order, starting with the first configuration until a configuration is found for which the current conditions meet its activation criteria. If such a configuration is found, it is designated the active configuration for the hour. If no configuration is found, then a configuration whose criteria most closely match the hourly conditions is selected. This



method ensures that a configuration is selected for every hour; and thus, no flights are canceled due to inclement weather.

When conditions for an hour do not meet the criteria of any configuration, configurations are matched using a metric that quantifies how distant the current conditions are from a configuration's criteria. Smaller values of this metric imply a better match (i.e., a "best fit"). Eq. 7-1 and Eq. 7-2 quantify criteria range and activation parameter distance, respectively, based on the two criteria bounds of a given activation parameter. If a bound is not specified for some configuration and activation parameter, then the respective extreme value is assumed to be the bound. Table 7-1 lists these extreme boundary values.

$$R_{ik} = U_{ik} - L_{ik} \quad \text{Eq. 7-1}$$

where

- $R_{ik}$  The criteria range for configuration  $i$  of activation parameter  $k$ ;  
 $U_{ik}$  The upper bound for configuration  $i$  of activation parameter  $k$ ; and  
 $L_{ik}$  The lower bound for configuration  $i$  of activation parameter  $k$ .

$$D_{ijk} = \max\{|U_{ik} - V_{jk}|, |L_{ik} - V_{jk}|\} \quad \text{Eq. 7-2}$$

where

- $D_{ijk}$  The distance of the value from the criteria for configuration  $i$ , hour  $j$  and activation parameter  $k$ ;  
 $U_{ik}$  The upper bound for configuration  $i$  of activation parameter  $k$ ;  
 $V_{jk}$  The value for hour  $j$  of activation parameter  $k$ ; and  
 $L_{ik}$  The lower bound for configuration  $i$  of activation parameter  $k$ .

Table 7-1 Assumed Extreme Values for Configuration Activation Parameters

Activation Parameter	Extreme Lower Bound	Extreme Upper Bound	Units
Wind Direction	0	359	Degrees
Wind Speed	0	100	Knots
Hour-of-Day	0	23	Hours
Ceiling	0	100,000	Feet
Visibility	0	100	Statute Miles
Temperature	-100	150	°F

Figure 7-1 is a graphic illustration of the relationships between the variables in Eq. 7-1 and Eq. 7-2.

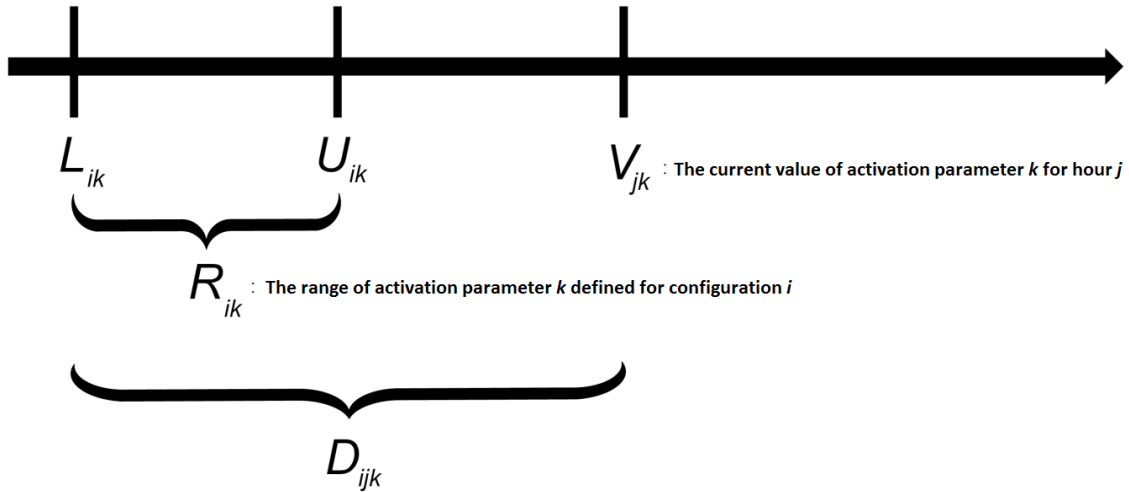

Figure 7-1 An Activation Parameter Value and its Criteria Range for Some Configuration and Hour

Eq. 7-3 normalizes the distance  $D_{ijk}$  of Eq. 7-2 by scaling it by the range  $R_{ik}$  of Eq. 7-1. Note that by design,  $R_{ik}$  and  $D_{ijk}$  never take on negative values.

$$\delta_{ijk} = \begin{cases} \frac{D_{ijk}}{R_{ik}}, & 0 < R_{ik} < D_{ijk} \\ +\infty, & R_{ik} = 0 < D_{ijk} \\ 0, & 0 \leq D_{ijk} \leq R_{ik} \end{cases} \quad \text{Eq. 7-3}$$

where

- $\delta_{ijk}$  The normalized distance for configuration  $i$ , hour  $j$ , and activation parameter  $k$ ;
- $D_{ijk}$  The pre-normalized distance of the value from the criteria for configuration  $i$ , hour  $j$ , and activation parameter  $k$ ; and
- $R_{ik}$  The range for configuration  $i$  of activation parameter  $k$ .

Eq. 7-4 computes the activation parameter metric by summing the normalized distances,  $\delta_{ijk}$ , of Eq. 7-3 over all activation parameters. The configuration with the smallest metric value for a given hour is designated the active configuration. Ties in metric value go to the configuration with higher priority (i.e., the one whose metric value was computed first). Algorithmically, for each hour  $j$ , an ordered list of configurations is evaluated until the first one whose index,  $\hat{i}$ , satisfies the condition  $\hat{i} = \arg(\min_i(\delta_{ij}))$ .

$$\delta_{ij} = \sum_k \delta_{ijk} \quad \text{Eq. 7-4}$$

where

$\delta_{ij}$  The activation parameter metric for configuration  $i$  and hour  $j$ ; and

$\delta_{ijk}$  The normalized distance for configuration  $i$ , hour  $j$ , and activation parameter  $k$ .

## 7.3 Taxiway Networks

The purpose of a taxi network is to provide a foundation for aircraft to perform temporally-sequenced ground movements. Furthermore, the taxi network provides the basis for localizing the emissions and constructing dispersion sources of these temporally-sequenced aircraft ground movements. A taxi network is composed of three physical airport layout components (gates, runways, and taxiways) as well as a relational one (taxipaths). Building a well-defined taxi network is necessary for metric results that intend on utilizing sequence modeling.

### 7.3.1 Taxi Network Elements and Terminology

#### **Gates**

Gates represent the starting location and ending destination for departure and arrival ground movements, respectively. The taxi network algorithm is flexible enough to interpret gates defined either as a single point or as a polygon composed of multiple points (i.e., terminal in AEDT). When resolving a taxi network for an airport layout, heligates are treated identically as regular gates.

#### **Runways**

The taxi network requires runways with two fully-defined runway ends. Without two fully-defined runway ends, it is impossible to determine the full extent of the runway. A runway end represents the ending destination of ground movements for departure operations. For arrival operations, a runway end represents the approximate start of runway ground-roll location.

Runway ends which are helipads are not considered suitable for taxi network analysis. Therefore, a runway with a child helipad runway end is not used by the taxi network algorithm.

#### **Taxiways**

Taxiways are physical components of an airport layout which aircraft use to move from a gate to a runway end and vice-versa. Each taxiway within an airport layout must be given a distinct name. A taxiway is defined by two or more points. Two consecutive points define a taxiway segment. Since each taxiway segment within a taxiway has a corresponding speed, users are allowed to define taxiways with speeds that vary by segment. Width is a property of the entire taxiway and is therefore constant across all segments.

One taxiway must not intersect another specific taxiway more than once. This rule is necessary in order to avoid ambiguity and is further described in Section 7.3.2.

#### **Runway Exit**

A runway exit represents the location on a runway (downstream of a runway end) at which a taxiway intersects the runway. A runway has as many runway exits as there are taxiways that intersect it.

**Taxipaths**

A taxipath is an ordered list of instructions which specify how to maneuver from a gate to a runway end (outbound taxipaths) or from a runway exit to a gate (inbound taxipaths). Users specify the ordered list of instructions as an ordered list of taxiways which they propose as a means to move from the start to the end of their taxipath. The taxi network algorithm transforms the ordered list of instructions (in the form of taxiways) into a concrete ordered list of geographical locations which an aircraft will actually follow from the start to the end location of the taxipath.

An outbound taxipath is strictly defined by the gate it where it begins, the ordered list of taxiways it traverses, and the runway end where it terminates. It is superfluous to define multiple outbound taxipaths that have the same gate/runway end pair, even if they differ in their ordered lists of taxiways. Downstream of the taxi network algorithm, the sequencing algorithm will select and assign to an air operation the first outbound taxipath it encounters that satisfies the gate/runway end pair of that air operation. The outbound taxipath selection for a particular gate/runway end pair is deterministic and will invariably reduce to the same selection each time one is requested.

In contrast, inbound taxipaths are defined by a runway exit (i.e., the taxiway used to get off the runway). Therefore, multiple inbound taxipaths with an identical runway end/gate pair but with different runway exits can be defined. The sequencing algorithm assigns an appropriate inbound taxipath at runtime based on the arrival operation's runway ground roll length.

When users create an air operation, they are responsible for assigning a gate to that air operation. For an air operation that is not expanded using operational profiles, it also becomes necessary to explicitly assign a runway end to that air operation. For an air operation that is expanded using operational profiles, runway end assignment is performed implicitly utilizing airport configurations.

**Node Map**

A node map is a list of all distinct calculated taxiway intersection points and user-defined taxiway points in a taxi network. User-defined points include the points that users provide to define physical taxi network elements (taxiways, runways, and gates). Calculated points include every point at which the three physical taxi network elements intersect. Each distinct point is transformed into a node. Distinctness of the points refers to a feature of the taxi network algorithm which combines points that are near-enough to each other into a single node. The definition of nearness is context-specific and is further described in Section 7.3.2.8. Nodes have a unique integer ID and can be one of five types: Gate, Runway End, Runway Exit, Taxiway, or Intersection.

**Network Link**

A network link is a segment that joins two distinct nodes from the node map. Since movement from one node to another always represents movement along one taxiway segment, the network link will have a speed property equal to the taxiway segment it is moving over and a width property equal to the taxiway it is navigating.

### **Network Map**

The network map integrates the taxipaths and node map of a taxi network and is therefore the ultimate result of the taxi network algorithm. A network map is generated by walking through each sequential pair of points in a taxipath and producing a pair of network links for that pair of points. The first network link produced represents movement from the first to the second point in the pair, while the second network link represents movement from the second point to the first. Therefore, the network map makes a connection for each pair of network nodes over which the user specifies movement (as laid down in their taxipath definitions).

### **7.3.2 Taxi Network Algorithm Overview**

The following nine steps represent a high-level overview of the algorithm that constructs a taxi network. Each step of the taxi network algorithm is explained in the following sub-sections.

1. Load Taxi Network Elements;
2. Verify Connectivity of Taxi Network Elements;
3. Calculate Taxiway-Taxiway Intersections;
4. Calculate Taxiway-Runway Intersections;
5. Calculate Taxiway-Gate Intersections;
6. Insert Calculated Intersections into Taxiways;
7. Transform Taxipaths from Lists of Taxiways into Lists of Indices along Taxiways;
8. Generate a Node Map using User-Defined and Calculated Intersection Points; and
9. Generate a Network Map using Taxipaths and the Node Map.

#### **7.3.2.1 Step 1 – Loading of Taxi Network Elements**

Users must define at least one of each of the four taxi network elements in order to create a taxi network. If there are no members defined for any of the four elements, the Delay and Sequencing Model cannot be processed.

**Gates:** Both gates and heligates within an airport layout will be loaded and treated identically by the algorithm. Heligates must be excluded from the airport layout if they are not intended to be used in the resolution of the taxi network. All subsequent descriptions of the algorithm will simply refer to the gates and heligates in an airport layout as “gates”. However, this term can refer to both gates and heligates.

**Runways:** All runways within an airport layout will be loaded. Runways without two opposite, fully-defined runway ends will be excluded from analysis by the taxi network. A runway with one or both runway ends that are helipads will be entirely excluded from the taxi network.

**Taxiways:** All taxiways within an airport layout will be loaded.

**Taxipaths:** All taxipaths within an airport layout will be loaded.

#### **7.3.2.2 Step 2 – Verification of Taxi Network Element Connectivity**

Once the taxi network elements have been loaded, the next step is to verify the integrity of the taxiways and taxipaths. For taxiways, this comprises a check to make sure that no two taxiways excessively

intersect each other. For taxipaths, this involves an examination to ensure that the sequential members of a taxipath intersect one another.

7.3.2.2.1 Taxiway Connectivity

Each segment of each taxiway is compared against the segments that constitute every other taxiway. This is done in order to determine the number of times that one taxiway intersects another.

As an example, consider the comparison of segment q of taxiway Q and segment r of taxiway R. This comparison is presented in Figure 7-2. Segment q is defined by two endpoints (End 1 and End 2). Segment r is defined by its own endpoints (End 1 and End 2). Taxiways Q and R have their own widths ( $w_q$  and  $w_r$ , respectively). These widths correspond to the widths of the taxiways segments.

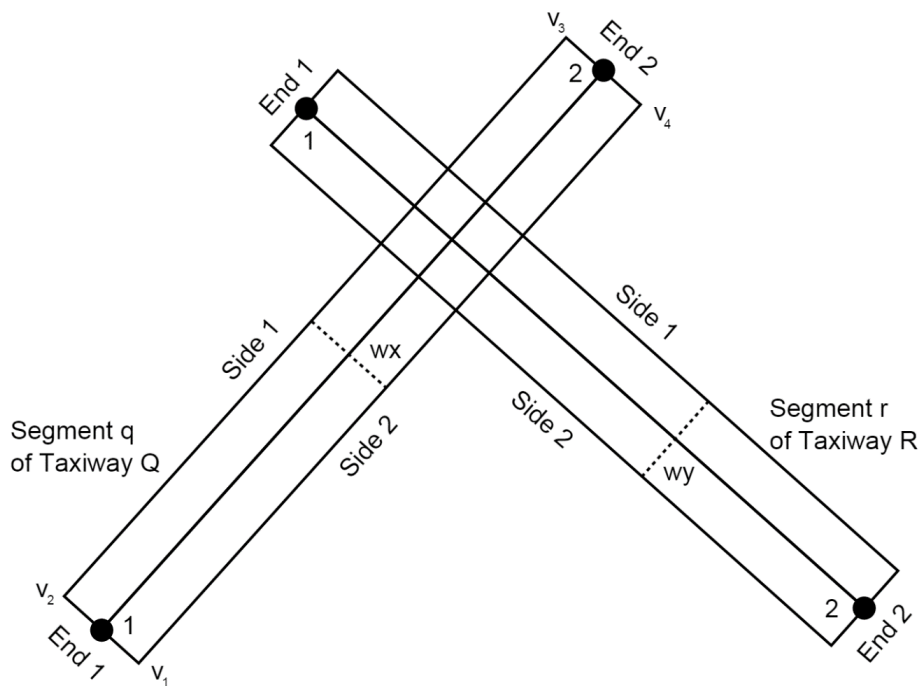

Figure 7-2 Intersection of Two Taxiway Segments (q and r)

The locations of the endpoints of the two segments (excluding altitude), combined with the widths of these two segments, are used to define the physical rectangle over which the segments extend. This is done by using Figure 7-2 to determine a unit vector normal to the straight line segment defined by a segment’s endpoints. The following equation presents the unit normal 2-D vector of a line defined by two points  $(x_1, y_1)$  and  $(x_2, y_2)$ .

$$\langle x_n, y_n \rangle = \left\langle \frac{(y_2 - y_1)}{\sqrt{(x_2 - x_1)^2 + (y_2 - y_1)^2}}, -\frac{(x_2 - x_1)}{\sqrt{(x_2 - x_1)^2 + (y_2 - y_1)^2}} \right\rangle \tag{Eq. 7-5}$$

The four vertices  $(v_1, v_2, v_3, v_4)$  that define the rectangular segment are presented in Eq. 7-6.

$$\begin{aligned}
 v_1(x, y) &= \left(x_1 + x_n \frac{w}{2}, y_1 + y_n \frac{w}{2}\right) \\
 v_2(x, y) &= \left(x_1 - x_n \frac{w}{2}, y_1 - y_n \frac{w}{2}\right) \\
 v_3(x, y) &= \left(x_2 + x_n \frac{w}{2}, y_2 + y_n \frac{w}{2}\right) \\
 v_4(x, y) &= \left(x_2 - x_n \frac{w}{2}, y_2 - y_n \frac{w}{2}\right)
 \end{aligned}
 \tag{Eq. 7-6}$$

where

w The width of a taxiway segment.

Each side of the rectangle is defined based on the vertices that make up its endpoint. The sides are defined as the following:

- End 1 is made by vertices 1 and 2;
- Side 1 is made by vertices 2 and 3;
- End 2 is made by vertices 3 and 4; and
- Side 2 is made by vertices 4 and 1.

Each side and end of a taxiway segment is then compared against each side and end of the other taxiway segment. If any of the eight combinations of sides and ends intersect, the two distinct taxiways are deemed to intersect.

AEDT must determine a potential intersection point  $p(x, y)$  of one line defined by endpoints  $p_1 = (x_1, y_1)$  and  $p_2 = (x_2, y_2)$  and another line defined by endpoints  $p_3 = (x_3, y_3)$  and  $p_4 = (x_4, y_4)$ . Equations in Eq. 7-7 are employed in this effort.

$$\begin{aligned}
 a_{1,2} &= y_2 - y_1 & a_{3,4} &= y_4 - y_3 \\
 b_{1,2} &= x_1 - x_2 & b_{3,4} &= x_3 - x_4 \\
 c_{1,2} &= x_2 y_1 - x_1 y_2 & c_{3,4} &= x_4 y_3 - x_3 y_4
 \end{aligned}$$

$$\alpha = \begin{bmatrix} a_{1,2} \\ a_{3,4} \\ b_{1,2} \\ b_{3,4} \end{bmatrix} = \begin{bmatrix} \alpha_1 \\ \alpha_2 \\ \alpha_3 \\ \alpha_4 \end{bmatrix} \qquad \beta = \begin{bmatrix} b_{3,4} \\ -a_{3,4} \\ -b_{1,2} \\ a_{1,2} \end{bmatrix} = \begin{bmatrix} \beta_1 \\ \beta_2 \\ \beta_3 \\ \beta_4 \end{bmatrix}
 \tag{Eq. 7-7}$$

$$\det(\alpha) = a_{1,2} b_{3,4} - b_{1,2} a_{3,4}$$

$$p(x, y) = \left( \frac{-\beta_1 c_{1,2} - \beta_3 c_{3,4}}{\det(\alpha)}, \frac{-\beta_2 c_{1,2} - \beta_4 c_{3,4}}{\det(\alpha)} \right)$$

The example presented in Figure 7-2 demonstrates this concept. There are four distinct points at which the two rectangular segments coincide. Since there is at least one point of coincidence, taxiways Q and

R are considered to intersect at segments q and r. Figure 7-3 shows a slightly different geometrical setup of the example taxiway segments presented in Figure 7-2. The straight line segments defined by the taxiway segments' endpoints do not intersect, but their rectangular representations do in fact intersect at two distinct locations. Therefore, these two modified representations of segments q and r also establish an intersection between taxiways Q and R.

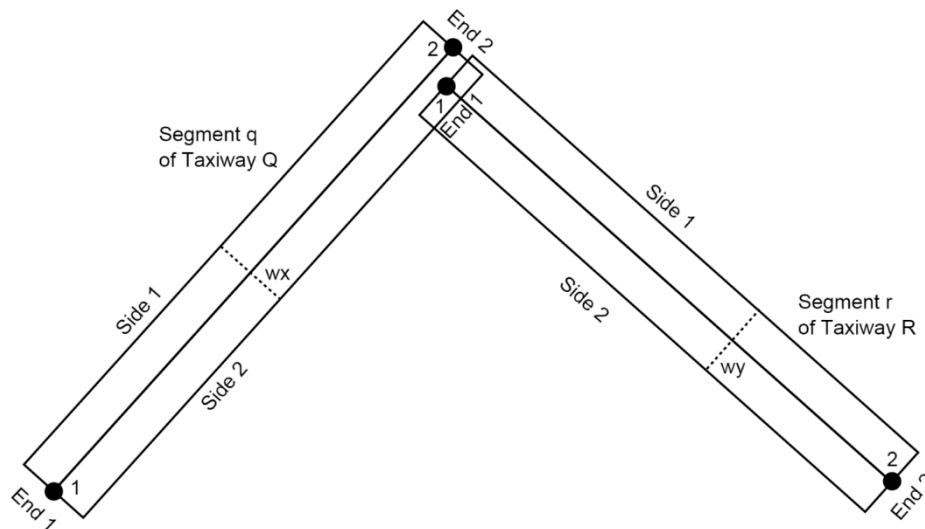

Figure 7-3 Modified Rectangular Representation of Two Taxiway Segments (Q and R)

A taxiway pair that intersects more than two times counts as an intersection error. If a taxi network analysis for an airport layout accumulates three such intersection errors, the resultant taxi network is deemed to be excessively erroneous. It should be noted that the determination that a taxi network is excessively erroneous does not stop the corresponding metric result. It merely prompts an error message which suggests a review of the definitions of the taxiways.

A single taxiway pair that intersects more than ten times counts as a single intersection error, but the resultant taxi network is immediately deemed excessively erroneous.

#### 7.3.2.2.2 Taxipath Connectivity

The integrity of each taxipath in the network is tested. The inspection is slightly different for outbound and inbound taxipaths.

For an outbound taxipath, the following checks are performed:

- The taxipath's gate intersects the first member taxiway of the taxipath;
- Each sequential pair of member taxiways intersect one another; and
- The parent runway of the taxipath's runway end intersects the last member taxiway of the taxipath.



---

For an inbound taxipath, the following checks are performed:

- The parent runway of the taxipath's runway end intersects the first member taxiway of the taxipath;
- Each sequential pair of member taxiways intersect one another; and
- The taxipath's gate intersects the last member taxiway of the taxipath.

If a taxipath does not satisfy any of the checks performed in its inspection, the taxipath will be removed from subsequent steps in the taxi network analysis.

#### 7.3.2.2.2.1 Taxiway-Taxiway Connectivity in Taxipaths

The determination of whether each sequential pair of member taxiways intersect one another is performed by analyzing the taxiway segments of each sequential pair of member taxiways in the same manner described in the preceding section. If any sequential pair of member taxiways does not intersect, the corresponding taxipath is marked for exclusion in the subsequent taxi network analysis.

#### 7.3.2.2.2.2 Taxiway-Runway Connectivity in Taxipaths

The determination of whether the last taxiway (for outbound taxipaths) or the first taxiway (for inbound taxipaths) intersects the appropriate runway is also performed using the algorithm presented in the preceding section. The only difference is that taxiway segments are compared against a single runway (instead of against another taxiway's segments). The runway is defined as a rectangular segment with the taxipath's runway end serving as one endpoint and the opposite runway end serving as the other endpoint.

#### 7.3.2.2.2.3 Taxiway-Gate Connectivity in Taxipaths

The determination of whether the first taxiway (for outbound taxipaths) or the last taxiway (for inbound taxipaths) intersects the taxipath's gate is performed in one of two ways depending on whether the gate is a point or a polygon.

Figure 7-4 demonstrates a taxiway segment intersection with a polygon gate. The routine used in Section 7.3.2.2.1 Taxiway Connectivity is utilized to determine if any of the sides/ends of the taxiway segment intersect any of the sides of the polygon gate. AEDT starts with End 1 of the taxiway segment and compares that end to each of the sides of the polygon (starting with the segment from polygon point 1 to polygon point 2). Side 1 of the taxiway segment is then compared against the sides of the polygon. All sides and ends of the taxiway segment are examined until it is determined that an intersection does indeed exist. For the geometry presented in Figure 7-4, this would occur on the sixth iteration when Side 1 of the taxiway segment is compared against the polygon gate segment from point 2 to point 3.

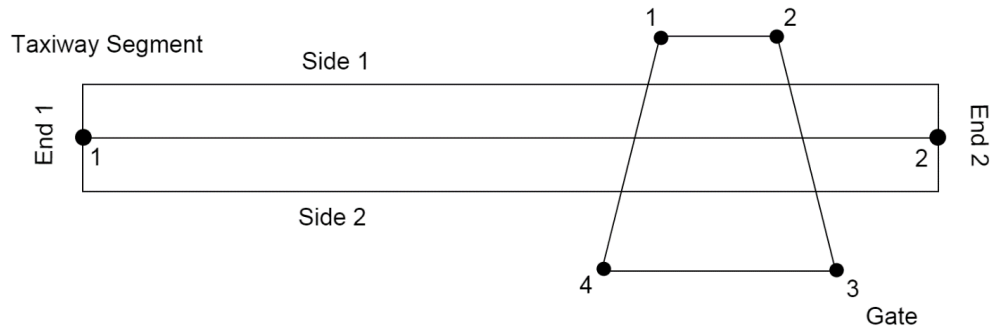

Figure 7-4 Taxiway Segment Intersection with a Polygon Gate

For gates defined by a single point, a different method is used to determine whether they intersect with a taxiway segment. Figure 7-5 shows a point gate ( $p$ ) in the vicinity of a line segment defined by the endpoints ( $p_1$  and  $p_2$ ) of a taxiway segment. The relative position of the projected point  $p_n$  along the segment is denoted  $f$ . A point gate is determined to intersect a taxiway segment if it is within the rectangle defined by the taxiway segment's endpoints and width. This determination is performed by geometrically projecting the gate point ( $p$ ) onto the line segment defined by the taxiway segment's endpoints ( $p_1$  and  $p_2$ ). The projected point is denoted  $p_n$ . Relative position (denoted by the symbol  $f$ ) represents how far the projected point  $p_n$  is along the segment from  $p_1$  to  $p_2$ . A relative position of zero means that  $p_n$  is exactly perpendicular to  $p_1$ . A relative position of unity means that  $p_n$  is exactly perpendicular to  $p_2$ . Relative positions less than 0 or greater than 1 are interpreted to mean that the projected point lies outside of the segment from  $p_1$  to  $p_2$ . Relative position can be determined by computing the dot product of the vectors from  $p_1$  to  $p$  and  $p_1$  to  $p_2$ , and dividing this result by the square of the magnitude of the vector from  $p_1$  to  $p_2$  (Eq. 7-8).

$$f = \frac{(p - p_1) \cdot (p_2 - p_1)}{|p_2 - p_1|^2} = \frac{(x - x_1)(x_2 - x_1) + (y - y_1)(y_2 - y_1)}{(x_2 - x_1)^2 + (y_2 - y_1)^2} \quad \text{Eq. 7-8}$$

The coordinates of the projected point are then determined using Eq. 7-9. This equation calculates Cartesian coordinates of a projected point  $p_n$  given relative position along two endpoints.

$$p_n(x_n, y_n) = (x_1 + f(x_2 - x_1), y_1 + f(y_2 - y_1)) \quad \text{Eq. 7-9}$$

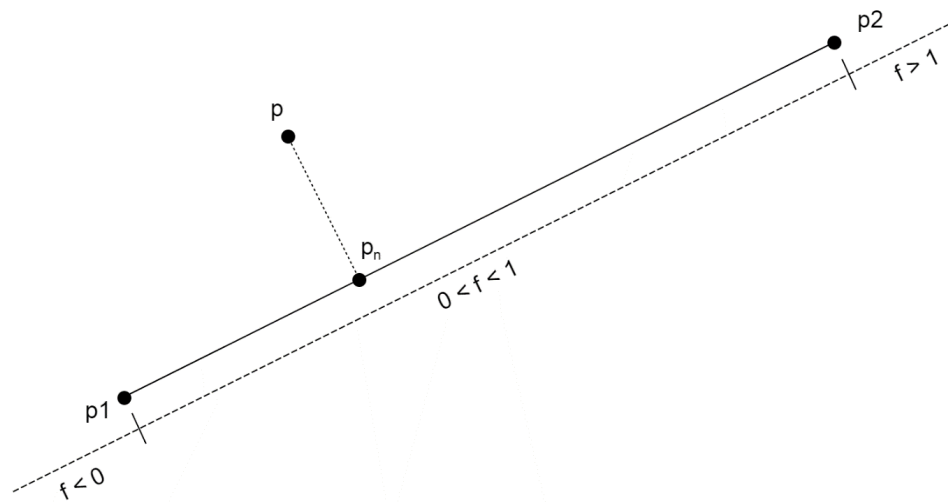

Figure 7-5 Projection of a Point p onto a Line Segment Defined by Endpoints p1 and p2

Depending on the value of the relative position determined from Eq. 7-8, the value of  $p_n$  determined from Eq. 7-9 may be reassigned. The reassigned values of  $p_n$  are summarized in Table 7-2.

Table 7-2 Reassigned Values of Projected Point  $p_n$

Relative Position	$p_n$ is set to:
$f < 0$	$p_1$
$0 \leq f \leq 1$	$p_n$
$f > 1$	$p_2$

If the distance between the reassigned value of  $p_n$  and the point gate is less than or equal to the half-width of the taxiway segment, the point gate is deemed to be within the taxiway segment and is considered to intersect.

**7.3.2.3 Step 3 – Calculation of Taxiway-Taxiway Intersections**

Taxiway intersections are calculated by comparing each combination of taxiways in the airport layout. Each pair of taxiways that actually intersect will produce two taxiway-taxiway intersection points; one point is where the first item in the pair intersects the second and the other point is where the second item intersects the first.

For illustrative purposes, take the example taxiways Q and R shown in Figure 7-6, each composed of one taxiway segment. When determining the location where taxiway R intersects taxiway Q, the intersections of the sides/ends of the two taxiways are ranked. The first-occurring side/end intersection in the following list will be used as the basis for determining the definitive location of the intersection of taxiway Q by taxiway R.

- Side 1 of Taxiway Q: Side 2, End 2, Side 1, End 1 (of Taxiway R)
- Side 2 of Taxiway Q: Side 2, End 2, Side 1, End 1 (of Taxiway R)
- End 1 of Taxiway Q: Side 2, End 2, Side 1, End 1 (of Taxiway R)
- End 2 of Taxiway Q: Side 2, End 2, Side 1, End 1 (of Taxiway R)

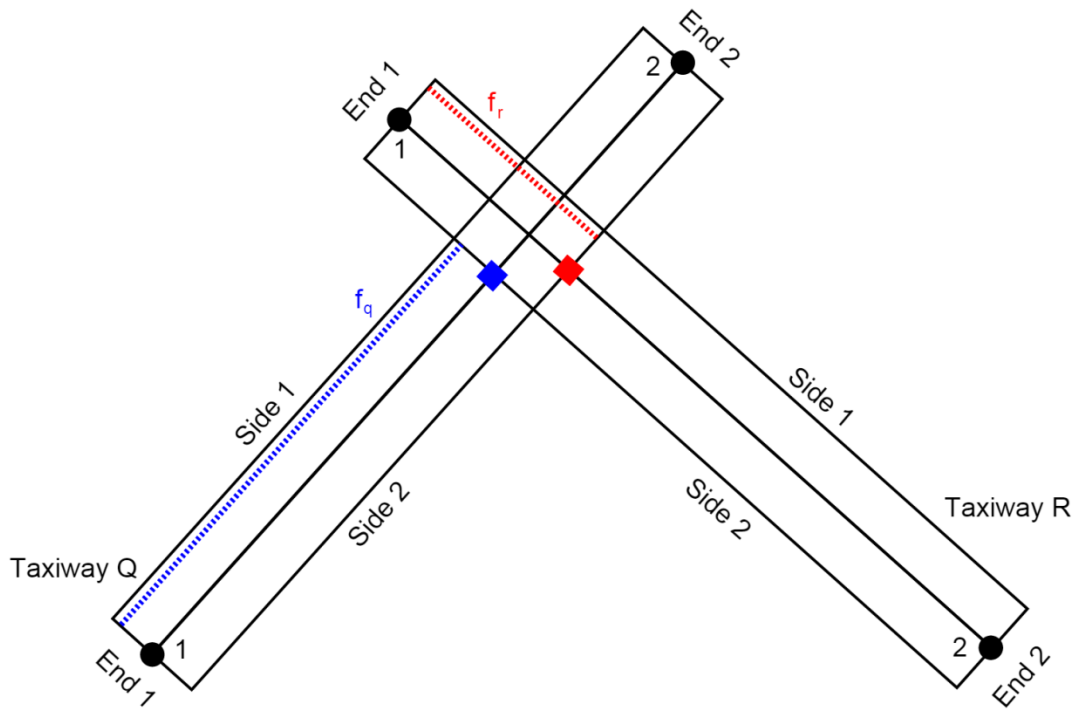

Figure 7-6 Intersection of Two Taxiways

The first pair in the list to occur is the intersection of side 1 of taxiway Q and side 2 of taxiway R. The location of the intersection of side 1 of taxiway Q and side 2 of taxiway R is then projected (using Eq. 7-8 and Eq. 7-9) onto the mid-line of taxiway Q. This point is shown as a blue square in Figure 7-6. The point is at a relative position of  $f_q$  on taxiway Q.

AEDT also determines the intersection of taxiway R by taxiway Q. Switching the references of the two taxiways in the order-of-precedence list leads to the conclusion that the location of the intersection of side 1 of taxiway R and side 2 of taxiway Q is used as the basis for the intersection of taxiway R by taxiway Q. The intersection location is projected onto taxiway R and is considered to be the location where taxiway Q intersects taxiway R. This point is shown as a red square in Figure 7-6. It occurs at a relative position of  $f_r$  along taxiway R.

Thus, each taxiway-taxiway intersection yields two intersection points. One intersection point is the relative position along the first taxiway at which the first taxiway is intersected by the second taxiway. The other taxiway intersection point is the relative position along the second taxiway at which the second taxiway is intersected by the first taxiway.

At this point-in-time in the algorithm, the definitions of taxiways only include user-defined points. The intent of calculating taxiway-taxiway intersection points is to potentially add the calculated intersection points to the definitions of the taxiways on which they occur. If a calculated intersection point's location is greater than one meter away from the user-defined points of the taxiway on which that calculated intersection point occurs, then the calculated intersection is added to a list of points (referred to as "Insert Points") which will be added to the definitions of the taxiways later on (Section 7.3.2.6).

In the current example, taxiway Q consists of two (user-defined) points, point 1 and point 2. If the calculated intersection of taxiway Q by taxiway R (shown in blue in Figure 7-6) is greater than one meter away from both of the two user-defined points, it will be added to the Insert Points list. Insert Points will in turn be used later to add the blue intersection point into the definition of taxiway Q. Taxiway Q will then consist of three points, which, in order, are: point 1, blue point, point 2. A similar action will be performed on taxiway R. Taxiway R will consist of its own point 1, red point, and its own point 2.

Additionally, the locations of each corresponding pair of taxiway-taxiway intersections are added to a separate list of pairs of points referred to as "Identical Points". Pairs of points are only added to "Identical Points" if the two points in the pair are greater than  $10^{-6}$  meters in distance from each other. The intent of Identical Points is to create a list of related taxiway-taxiway intersection locations for later use. Identical Points are pairs of points which are physically distinct, but are nonetheless functionally related. In practice, Identical Points can be tens of meters away from each other. Using the example presented in Figure 7-5, an entry of the form <location of blue point, location of red point> and another of the form <location of blue point, location of red point> are added to Identical Points for the intersection of Taxiways Q and R.

Furthermore, the taxi network analysis stores a list of taxiway-taxiway intersects. These intersects are stored in the form <Taxiway 1, Taxiway 2, Location 1, Location 2>. Location 1 is the location where Taxiway 2 intersects Taxiway 1 and Location 2 is the location where Taxiway 1 intersects Taxiway 2. For the example shown in Figure 7-6, taxiway-taxiway intersects will contain two entries <Q, R, location of blue point, location of red point> and <R, Q, location of red point, location of blue point>. This list is useful in quickly determining the exact location where one taxiway intersects another.

#### **7.3.2.4 Step 4 – Calculation of Taxiway-Runway Intersections**

The geographic point where runways of the airport layout intersect taxiways is determined by comparing each runway against each taxiway.

The determination of taxiway-runway intersections is performed in an analogous manner as the calculation of taxiway-taxiway intersections. The main difference is that one of the rectangular taxiway segments is replaced by a rectangular runway defined by two opposite runway ends serving as endpoints and a width equal to the runway's width. Figure 7-7 shows a basic schematic of the intersection of a runway (defined by a runway end and its opposite runway end) and a taxiway segment.

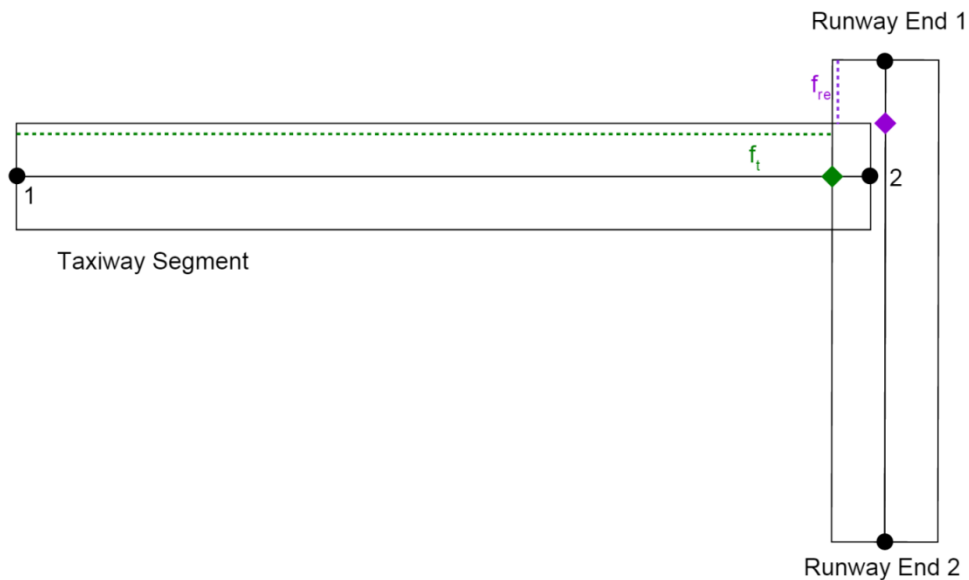

Figure 7-7 Taxiway-Runway Intersection

By applying the intersection order-of-precedence rules previously outlined (Section 7.3.2.3), the runway intersects the taxiway segment at the green point in Figure 7-7. The intersection is at a relative position  $f_t$  along the taxiway. This intersection position is added to the Insert Points for the taxiway.

The purple point is the location where the taxiway intersects the runway. It occurs at a relative position  $f_{re}$  along the runway. This location is not added to Insert Points since Insert Points contains only locations where taxiways are intersected.

For each taxiway, the taxiway-runway intersections are calculated by constructing a runway using the opposite runway end of each runway end defined in the airport layout. Each intersection calculation is therefore performed twice.

For the geometry defined in Figure 7-7, the intersection point shown in green will result in the same location for the taxiway-runway intersect calculation that uses runway end 2 as the initial position of the runway. Thus, the second, identical taxiway-runway intersect will be added to Insert Points.

The taxi network analysis also maintains a list of taxiway-runway intersects. These intersects are stored in the form <Taxiway, Runway End, Taxiway Intersection Location, Taxiway Intersection Location>. For the example presented in Figure 7-7, two entries will be added: <Taxiway, Runway End 1, location of green point, location of green point> and <Taxiway, Runway End 2, location of green point, location of green point>.

### 7.3.2.5 Step 5 – Calculation of Taxiway-Gate Intersections

This step compares each gate in the airport layout against each taxiway in the same airport layout to determine the locations where taxiways are intersected by gates.

The intersection of gates with taxiways was introduced in Section 7.3.2.2.3. The polygon gate geometry presented in Figure 7-4 is presented once again in Figure 7-8.

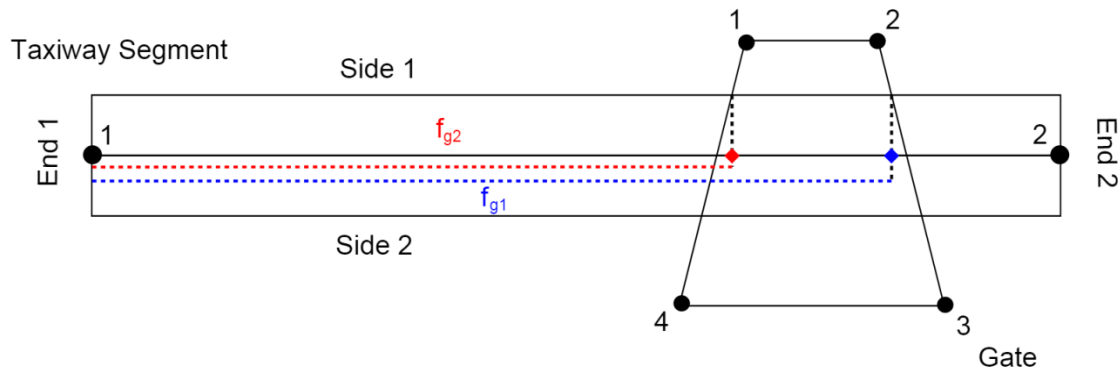

Figure 7-8 Taxiway-Gate Intersections

In order to determine the location where a gate intersects a taxiway segment, each side of a polygon gate is resolved as a rectangular segment of zero width. Thus, the same routine used in analyzing taxiway-taxiway and taxiway-runway intersections can be utilized to determine taxiway-gate intersections. Each polygon side is then compared against a taxiway segment. Using the example in Figure 7-8 and the order-of-precedence rules, one intersection is determined to occur at side 1 of the taxiway segment and the segment defined from point 2 to point 3 of the gate. Another intersection is determined to occur at side 1 of the taxiway segment and the gate segment from point 4 to point 1. Those two intersection points are projected onto the taxiway and occur at relative positions  $f_{g1}$  and  $f_{g2}$ , respectively. Both of these relative positions are added to the taxi network's Insert Points corresponding to the parent taxiway of the taxiway segment.

Similarly for taxiway-taxiway and taxiway-runway intersects, the taxi network analysis maintains a list of taxiway-gate intersects which are stored in the form <Taxiway, Gate, Taxiway Intersection Location, Taxiway Intersection Location>. For the example presented in Figure 7-8, two entries will be added to the taxiway-gate intersect list: <Taxiway, Gate, location of red point, location of red point> and <Taxiway, Gate, location of blue point, location of blue point>.

### 7.3.2.6 Step 6 – Insertion of Calculated Intersections into Taxiways

For each taxiway in the airport layout, this step inserts points into the definition of a taxiway where that taxiway was intersected by other taxiways, runways, and gates.

At this point taxiway-taxiway, taxiway-runway, and taxiway-gate intersections have been determined. Each taxiway in the taxi network contains entries in the Insert Points list of where it was intersected by other taxiways, runways, and gates. For each taxiway, intersection locations in Insert Points are stored in terms of relative position along that taxiway.

A simple taxi network is presented in Figure 7-9. This taxi network contains four taxiways (A, B, C, and D), one polygon gate, and one runway (defined by runway ends 1 and 2). Figure 7-9 shows points defined by the user.

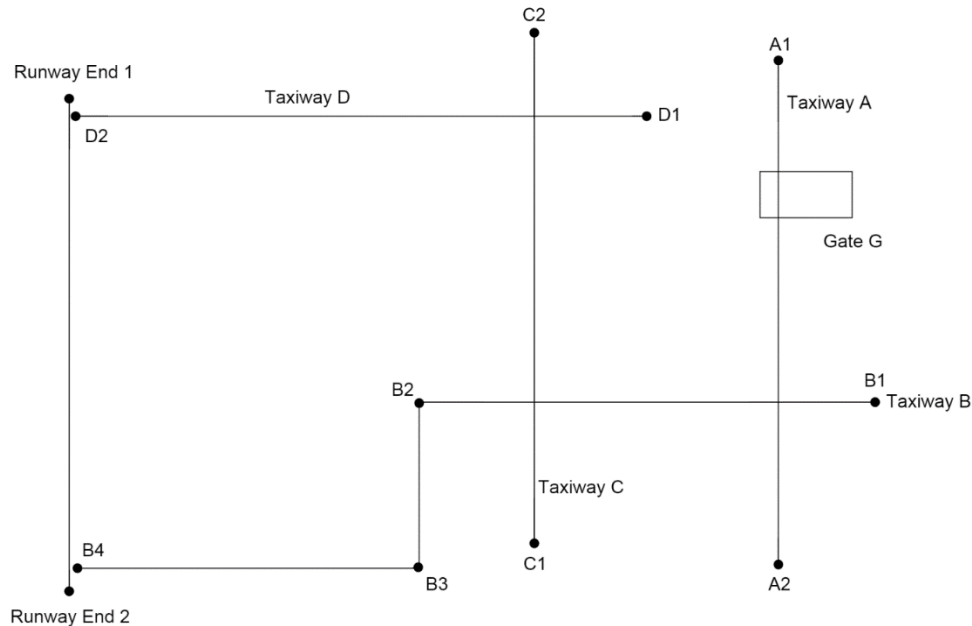

Figure 7-9 Simple Taxi Network

Before step 6 of the taxi network algorithm, taxiway definitions consist solely of the user-defined points shown in Figure 7-9. Thus, Taxiway A is defined by {A1, A2}, Taxiway B by {B1, B2, B3, B4}, etc. Figure 7-10 shows the taxiways intersection points as determined by steps 3, 4, and 5 of the taxi network algorithm.

Table 7-3 through Table 7-7 show the byproducts calculated by steps 3, 4, and 5. Table 7-6 is used to redefine the definitions of the taxi network's taxiways. Each Insert Point in Table 7-6 is inserted into the definition of its corresponding taxiway under the condition that the relative position ( $f$ ) of the Insert Point being added to the taxiway is  $10^{-6}$  greater than that of the previous point in the taxiway.

Assuming that each relative position ( $f$ ) in Table 7-6 is  $10^{-6}$  greater than the relative position of the taxiway location after which it would be placed, the new definitions of the taxiways in the example taxi network would be: {A1, GA1, GA2, AB, A2} for Taxiway A, {B1, BA, BC, B2, B3, RB, B4} for Taxiway B, {C1, CB, CD, C2} for Taxiway C, and {D1, DC, RD, D2} for Taxiway D.



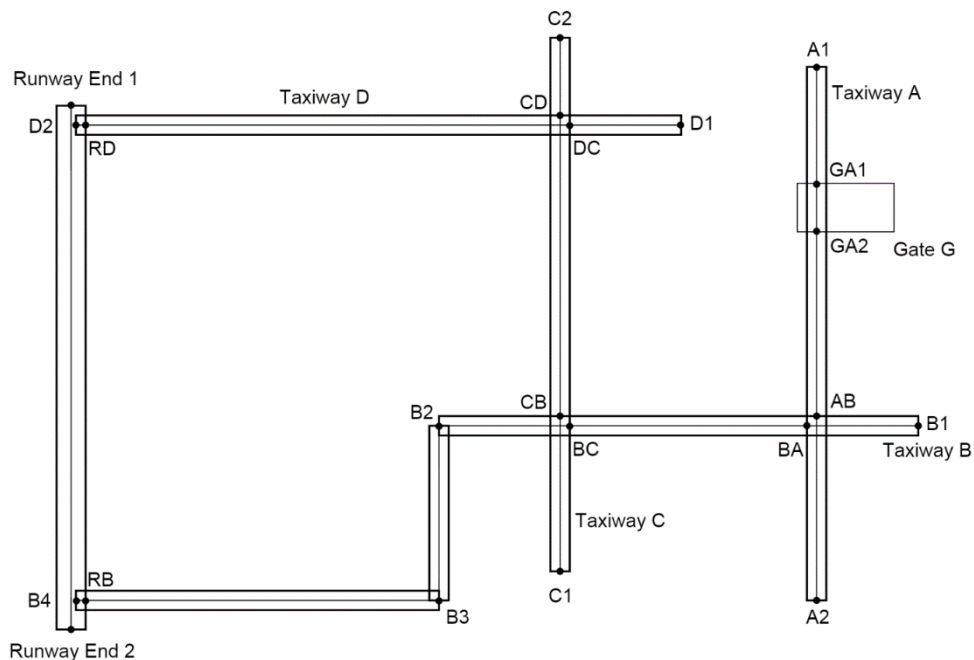

Figure 7-10 Simple Taxi Network with Intersection Points

Taxiway-Taxiway Intersections are labeled XY, where XY represents where Taxiway X is intersected by Taxiway Y. An assumption is made that each pair of taxiway-taxiway intersection points are greater than 1 meter in distance from each other.

Table 7-3 Taxiway-Taxiway Intersections Calculated for the Taxi Network Shown in Figure 7-9 and Figure 7-10

Taxiway 1	Taxiway 2	Location 1	Location 2
A	B	AB	BA
B	A	BA	AB
B	C	BC	CB
C	B	CB	BC
C	D	CD	DC
D	C	DC	CD

Table 7-4 Taxiway-Runway Intersections Calculated for the Taxi Network Shown in Figure 7-9 and Figure 7-10

Taxiway	Runway End	Intersection Location
B	Runway End 1	RB
B	Runway End 2	RB
D	Runway End 1	RD
D	Runway End 2	RD

Table 7-5 Taxiway-Gate Intersections Calculated for the Taxi Network Shown in Figure 7-9 and Figure 7-10

Taxiway	Gate	Intersection Location
A	G	GA1
A	G	GA2

Table 7-6 Insert Points for Each Taxiway in the Taxi Network Shown in Figure 7-9 and Figure 7-10

Taxiway	Relative Position on Taxiway	Location on Taxiway
A	GA1	GA1
A	GA2	GA2
A	AB	AB
B	BA	BA
B	BC	BC
B	RB	RB
C	CB	CB
C	CD	CD
D	DC	DC
D	RD	RD

Table 7-7 Identical Points for Each Taxiway in the Taxi Network Shown in Figure 7-9 and Figure 7-10

Location 1	Location 2
AB	BA
BA	AB
BC	CB
CB	BC
CD	DC
DC	CD

### 7.3.2.7 Step 7 – Transformation of Taxipaths

This step translates the definitions of all taxipaths in the airport layout from user-defined ordered lists of taxiways into lists of indices along the user-specified taxiways. In this context, index refers to the position of an item within a memory structure. For Taxiway A presented in the previous section, point A1 occurs at index 0, point GA1 at index 1, etc.

To aid in the description of this step, imagine an outbound taxipath from Gate G to Runway End 1 as a list of taxiways: {A, B, C, D} in the taxi network shown in Figure 7-9.

#### 7.3.2.7.1 Determine Taxiway-Taxiway Intersections

Taxiway indices are determined where the taxipath switches from one taxiway to another. For the example taxipath, this will consist of determining the index of the position of taxiway A at which it is crossed by Taxiway B as well as the index of the position of Taxiway B at which it is crossed by Taxiway

A. Similar determinations are performed for the switch from Taxiway B to Taxiway C and for the switch from Taxiway C to Taxiway D.

The task of finding the taxiway indices for a taxiway switch is performed by searching through the taxiway-taxiway intersections determined in step 3 until the single intersection that corresponds to the taxiway that is being switched from (Taxiway 1 in taxiway-taxiway intersections) to the taxiway that is being switched to (Taxiway 2 in taxiway-taxiway intersections) is found. Next, the positions in the definition of Taxiway 1 are searched until a position in Taxiway 1 is found that is within 1 meter of location 1 in the corresponding taxiway-taxiway intersection. The index of that position in Taxiway 1 is the index of Taxiway 1 at which a switch will occur to Taxiway 2. Afterwards, the positions in the definition of Taxiway 2 are searched until a position in Taxiway 2 is found that is within 1 meter of location 2 in the corresponding taxiway-taxiway intersection. That position's index in Taxiway 2 is the index of Taxiway 2 at which a switch occurred from Taxiway 1 of the taxiway-taxiway intersection.

After the index-finding routine is applied to each of the three taxiway switches in the example taxipath, the taxipath's corresponding ordered list of taxiway indices will resemble what is shown in Table 7-8.

Table 7-8 Taxiway Indices for the new definition of the example taxipath; so far, only switches from one taxiway to the next are conveyed in the new taxipath definition.

Taxiway	Index of Taxiway
A	3
B	1
B	2
C	1
C	2
D	1

The taxipath's corresponding ordered list of taxiway indices only contains taxiway indices corresponding to switches from one taxiway to another.

#### 7.3.2.7.2 Determine Taxiway-Gate Intersections

The index of the taxiway location at which the appropriate taxiway intersects the taxipath's gate is determined, accounting for whether a taxipath is inbound or outbound. For outbound taxipaths, the appropriate taxiway is the first taxiway in the user-defined taxiway list. For inbound taxipaths, the appropriate taxiway is the last one defined in the taxiway list.

Once the appropriate taxiway is determined, a search is done to find all taxiway-gate intersections whose taxiway corresponds to the appropriate taxiway and whose gate corresponds to the taxipath's gate. In the event that the search returns multiple candidates, AEDT simply selects the first candidate as the taxiway-gate intersection.

Once the taxiway-gate intersection has been selected, the location of that taxiway-gate intersection is compared against the positions of the appropriate taxiway. The index of the first position of the

appropriate taxiway to be less than 1 meter away from the location of the intersection is considered the index of the appropriate taxiway at which that taxiway intersects a gate.

For outbound taxipaths, this index is added as the initial entry to the new definition of the taxipath. For inbound taxipaths, this index is added as the final entry to the new definition of the taxipath.

In the example taxipath, the first taxiway in the user-defined taxipath is Taxiway A. This taxiway is expected to intersect the taxipath's gate (Gate G). A search through taxi network's taxiway-gate intersections returns both entries in Table 7-5 as being taxiway-gate intersection candidates. The first item is selected as the appropriate taxiway-gate intersection. The positions of Taxiway A are searched until the position that is within 1 meter of the appropriate taxiway-gate intersection is found. The index of that position (index 1) is then added as the initial entry of the new taxipath definition. The result is shown in Table 7-9.

Table 7-9 Taxiway Indices for the new definition of the example taxipath; so far, the definition contains the switch from the gate to the first taxiway and switches from one taxiway to the next.

Taxiway	Index of Taxiway
A	1
A	3
B	1
B	2
C	1
C	2
D	1

#### 7.3.2.7.3 Determine Taxiway-Runway Intersections

The index of the position of the appropriate taxiway that intersects the taxipath's runway is determined, accounting for whether a taxipath is inbound or outbound. For outbound taxipaths, the appropriate taxiway is the last taxiway of the taxipath's user-defined ordered taxiway list, while for inbound taxipaths it is the first such item.

A search is performed in the taxi network's taxiway-runway intersections whose taxiway is the same as the taxipath's appropriate taxiway and whose runway end is either the taxipath's runway end or the runway end opposite of the taxipath's runway end. For the first candidate taxiway-runway intersection, a search is performed on the appropriate taxiway for the position on that taxiway which is within 1 meter of the location of the candidate taxiway-runway intersection. The distance of that taxiway position to the candidate taxiway-runway intersection's runway end is calculated. A similar treatment is performed on all other candidate taxiway-runway intersections. The taxiway-runway intersection candidate with the least distance from its corresponding runway end to the taxiway-runway intersection location is selected as the actual taxiway-runway intersection.

The example taxipath's runway end is Runway End 1 and its last taxiway is Taxiway D. The runway end opposite to Runway End 1 is Runway End 2. Therefore, all elements in taxiway-runway intersections whose taxiway is equal to Taxiway D and whose runway end is equal to either Runway End 1 or Runway End 2 are selected. These selections correspond to the last two items of Table 7-10. Both of these candidate taxiway-runway intersections have locations that correspond to point RD. A search is performed on Taxiway D for the position on Taxiway D that is less than 1 meter away from the location of the first candidate taxiway-runway intersection (point RD). A search is also performed on Taxiway D for the position on Taxiway D that is less than 1 meter away from the location of the second candidate taxiway-runway intersection. The distance from the selected position on Taxiway D to Runway End 1 is less than the distance from the selected position on Taxiway D to Runway End 2. Therefore, the taxiway-runway intersection with Taxiway D and Runway End 1 is selected as the taxiway-runway intersection for the taxipath. The index of the selected position of Taxiway D that was less than 1 meter away from the Taxiway D / Runway End 1 intersection is then added to the new taxipath definition. The result is shown in Table 7-10.

Table 7-10 Taxiway Indices for the new definition of the example taxipath; so far, the definition contains the switch from the gate to the first taxiway, switches from one taxiway to the next, and the switch from the last taxiway to the runway.

Taxiway	Index of Taxiway
A	1
A	3
B	1
B	2
C	1
C	2
D	1
D	2

#### 7.3.2.7.4 Fill in Intermediate Taxiway Indices

Missing intermediate taxiway indices for each redefined taxipath are computed.

Thus far, each redefined taxipath consists of taxiway indices corresponding to:

- The taxiway position at which the taxipath's gate intersects the first taxiway in the taxipath (for outbound taxipaths) or the last taxiway (for inbound taxipaths);
- The taxiway positions at which the taxipath switches from one taxiway to the subsequent taxiway; and
- The taxiway position at which the runway defined by the taxipath's runway end intersects the last taxiway in the taxipath (for outbound taxipaths) or the first taxiway (for inbound taxipaths).

The redefined taxipath should contain two contiguous entries for each taxiway in its original (user-defined) definition. If the indices for each pair of same-taxiway entries are not continuous, additional

entries are added to the redefined taxipath in order to make the indices of same-taxiway entries continuous. This is necessary because movement from one taxiway index to another arbitrary taxiway index requires movement through all intermediary taxiway indices.

Continuing with the example taxipath, it becomes evident that movement along Taxiway A jumps from the taxiway position at index 1 to the one at index 3. An entry is added in between these two entries corresponding to index 2 of Taxiway A. Movement along Taxiways B, C, and D are already continuous and therefore no additional entries are necessary for these taxiways. The result is shown in Table 7-11.

Table 7-11 Taxiway Indices for the new definition of the example taxipath; the definition now contains the taxiway indices for movement along the entire taxipath (from gate to each taxiway to the runway).

Taxiway	Index of Taxiway
A	1
A	2
A	3
B	1
B	2
C	1
C	2
D	1
D	2

#### 7.3.2.8 Step 8 – Generation of Node Map

A centralized, simplified list of user-defined taxiway points and the three types of taxiway intersection points is created. Simplification of these points is achieved by combining all points that are near enough to taxiway-taxiway intersection into a single point. The simplified, potentially-fused taxiway points are referred to as nodes. Each node has a unique integer identification number (ID).

Node map generation is a two-staged process. The first stage is to create a distinct node for each taxiway point (which at this point in time can be one of the following types: user-defined, taxiway-taxiway intersection, taxiway-runway intersection, or taxiway-gate intersection) that is greater than 1 meter away from a taxiway-taxiway intersection (as defined in the “Identical Points” container introduced in step 3 of the algorithm). The first stage will create a distinct node for each user-defined taxiway point, taxiway-runway intersection, and taxiway-gate intersection that is greater than 1 meter away from a taxiway-taxiway intersection. Taxiway-taxiway intersections are excluded since they cannot, by definition, be more than a meter away from a taxiway-taxiway intersection. The second stage of the process is to create a single, distinct node for taxiway points that occur within 1 meter of either point in an entry in the Identical Points container. Distinct nodes are created by reducing each single taxiway-taxiway intersection to a single location. Additionally, user-defined taxiway points, taxiway-runway intersections, taxiway-gate intersections, and even other taxiway-taxiway intersections that are within 1 meter of a taxiway-taxiway intersection are combined using the single location of this taxiway-taxiway intersection.

The node map generation process is performed by evaluating all taxiway positions of each taxiway in the airport layout's taxi network. For each taxiway position, a search is performed on each entry of Identical Points:

- If there is no entry in Identical Points which is within 1 meter of the taxiway position currently being inspected, a node is created corresponding to this taxiway position. If no node in the node map is within  $10^{-3}$  meters of this newly-created node, the newly created node is added to the node map.
- If there is an entry in Identical Points which is within 1 meter of the taxiway position being inspected, simply move on to the next taxiway position.

At the conclusion of this first inspection of all taxiway positions, the node map will consist of unique nodes that correspond to user-defined taxiway points, taxiway-runway intersections, and taxiway-gate intersections that are greater than 1 meter away from an Identical Point (taxiway-taxiway intersection) entry. All nodes generated by this step are marked as being "Taxiway" nodes (later portions of the algorithm will mark some of these nodes as being of a more appropriate type).

Continuing with the example taxi network layout presented in Figure 7-10, the conclusion of the first taxiway position inspection will yield a node map with 14 entries. The IDs and locations of these nodes are presented in Table 7-12. The nodes in Table 7-12 only capture taxiway positions that are user-defined, runway intersections, and gate intersections.

Table 7-12 Nodes generated after the first pass over all taxiway positions for the taxi network layout presented in Figure 7-10.

Node ID	Location
0	A1
1	GA1
2	GA2
3	A2
4	B1
5	B2
6	B3
7	RB
8	B4
9	C1
10	C2
11	D1
12	RD
13	D2

Additionally, each taxiway in the taxi network generates a node ID list. The node ID list for each taxiway contains the same amount of entries as there are positions in that taxiway. The intent of this list is to create a mapping that relates each taxiway position to its corresponding node's ID number. So far, only

taxiway positions within  $10^{-3}$  meters of an existing node have a corresponding node ID. Taxiway positions which are not yet tied to a node do not have a corresponding node ID.

The node ID lists for each of the taxiways of the layout presented in Figure 7-10 are:

- Taxiway A: [0, 1, 2, Invalid, 3]
- Taxiway B: [4, Invalid, Invalid, 5, 6, 7, 8]
- Taxiway C: [9, Invalid, Invalid, 10]
- Taxiway D: [11, Invalid, 12, 13]

Positions marked invalid correspond to positions for which a corresponding node has yet to be created.

For each taxiway position without a corresponding node, a search is performed on each entry of Identical Points until an entry in this latter list is found which is 1 meter or less in distance to the taxiway position being inspected:

- If there is no already-existing node in the node map which is within 1 meter of either location of that makes up the selected Identical Point, create a new node and add it to the node map. Add a reference to this newly-created node in the corresponding taxiway's node ID list.
- If there is an already-existing node in the node map which is within 1 meter of either location that makes up the selected Identical Point, there is no need to create a new node. Simply add a reference to the already-existing node in the corresponding taxiway's node ID list.

When all taxiway positions have been evaluated, the node map will contain unique nodes that correspond to taxiway points that are greater than 1 meter away from taxiway-taxiway intersections (generated in the first stage) and unique nodes that correspond to simplified versions of taxiway-taxiway intersections. All nodes generated in this second step are marked as being "Intersection" nodes.

Table 7-13 presents the additional nodes that are generated.

Table 7-13 Additional nodes generated after the second pass over all taxiway positions in the taxi network layout presented in Figure 7-10.

Node ID	Location
14	AB (not BA)
15	BC (not CB)
16	CD (not DC)

The node ID lists of each taxiway in the example taxi network layout are:

- Taxiway A: [0, 1, 2, 14, 3]
- Taxiway B: [4, 14, 15, 5, 6, 7, 8]
- Taxiway C: [9, 15, 16, 10]
- Taxiway D: [11, 16, 12, 13]



### 7.3.2.9 Step 9 – Generation of Network Map

The network map is a list of segments that represent movement from one node to another. Segments will only be generated for movements that are expected to occur. Expectation of occurrence is based on the user-defined taxipaths of the airport layout.

#### 7.3.2.9.1 Network Link Generation

Each taxiway-index version of each taxipath (see Table 7-11 for an example) is evaluated. A network link is created for the movement from the first taxiway index to the second, another network link is created for the movement from the second taxiway index to the third, and so on. Network links are also generated for reverse movements (i.e., second taxiway index to the first, third taxiway index to the second, etc.). Network links are rectangular segments whose areas serve as the basis for emissions dispersion modeling. Therefore, the outcomes of the generation of network links are propagated beyond the taxi network analysis.

Table 7-14 shows the taxiway indices for the example outbound taxipath that moves from Gate G to Runway End 1, as well as the nodes that correspond to each taxiway index. It should be noted that switches from one taxiway to another correspond to a switch from one node to the same node.

Table 7-14 Taxiway Indices of the example outbound taxipath (Gate G -> Runway End 1) along with the node IDs corresponding to each taxiway index.

Taxiway	Index of Taxiway	Node ID
A	1	1
A	2	2
A	3	14
B	1	14
B	2	15
C	1	15
C	2	16
D	1	16
D	2	12

Network links are generated by evaluating the entries in the taxiway-index version of the taxipath being processed. The first entry corresponds to either a gate location (for outbound taxipaths) or a runway end/exit (for inbound taxipaths). The node corresponding to the first entry for outbound taxipaths has its type changed to “Gate”. For inbound taxipaths, the first node entry of a taxipath is either marked as “Runway End” or “Runway Exit”. If the distance from the node to the taxipath’s runway end is greater than one-and-a-half times the corresponding runway width, the node is marked as a “Runway Exit”. Otherwise, it occurs sufficiently near the taxipath’s runway end and is therefore marked as a “Runway End”.

For subsequent nodes in the taxiway-index version of the taxipath, a network link is generated which captures movement from the previous node to the current node. The properties of the network link (link width and link speed) are based off of the taxiway position corresponding to the current node (and

not the previous node). Network links have an additional property called queue capacity, which represents the amount of aircraft (regardless of actual aircraft size) that the link can support. Queue capacity is equal to the ceiling of the link length divided by 150 ft. Each network link will have the capacity to support at least one aircraft. A second network link which captures movement from the current node to the previous node is also generated. The properties of this second link are identical to the properties of the network link that captured movement from the previous node to the current node.

The first network link generated for the example taxipath will represent movement from node 1 to node 2. The width of this link will correspond to the width of Taxiway A. The speed of this link will correspond to the taxiway speed of the first taxiway position in Taxiway A whose node ID list entry is equal to 2. This reduces to the speed of the third taxiway position element for Taxiway A. The length of the link is set to the distance between the locations of node 1 to node 2. All previous steps of the taxi network algorithm used two-dimensional locations by neglecting the altitude property of airport layout elements. When determining network link length, the full three-dimensional coordinates of the nodes are used. A second network link that represents movement from node 2 to node 1 is generated and added to the network map. The properties of this second link are identical to the properties of the link from node 1 to node 2.

The node corresponding to the last entry in the taxiway-index version of the taxipath requires further processing. This last node represents either a gate location (for inbound taxipaths) or a runway end/exit (for outbound taxipaths).

#### 7.3.2.9.2 Network Path Generation

The final manifestation of a taxipath is referred to as a network path. Among several other properties, network paths contain an ordered list of nodes (a path) that correspond to movement of the corresponding taxipath along the taxi network. The path of the example taxipath is shown in Table 7-15. The repeated node IDs in Table 7-14 are not repeated in the path shown in Table 7-15.

Table 7-15 Network Path Version of the Example Taxipath

Node ID
1
2
14
15
16
12

A network path contains several properties (gate, runway end, and opposite runway end) which correspond to the taxipath that it was created from. It also contains the additional properties of exit distance, exit angle, and maximum exit speed. These three latter properties are only valid for inbound network paths and are left undefined for outbound network paths. These properties are defined with the aid of Figure 7-11.

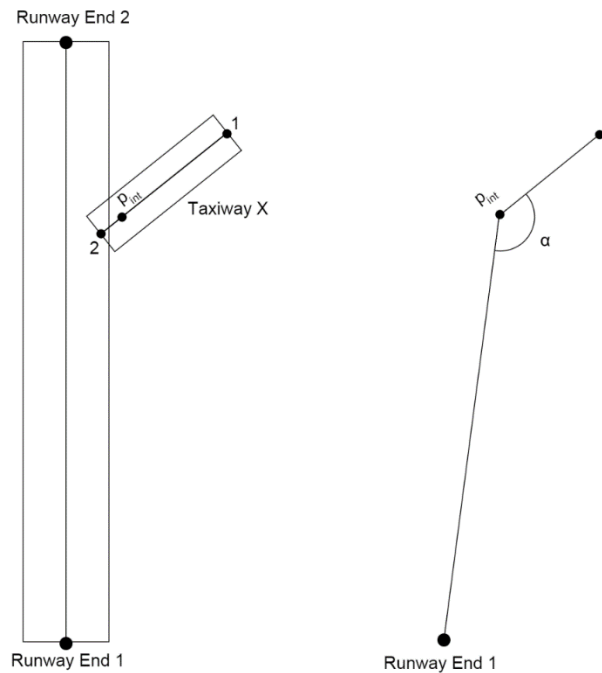

Figure 7-11 Inbound Network Path Exit Property Definitions

For an inbound network path that lands on Runway End 1 and exits the runway using Taxiway X in Figure 7-11, the first node in the network path will correspond to the intersection of Taxiway X and the runway ( $p_{int}$ ). Assuming that the second node of the inbound path is point 1 in Figure 7-11, the inbound path properties are defined as follows:

**Exit Distance** – The two-dimensional (excluding altitude) distance from Runway End 1 to  $p_{int}$ .

**Exit Angle** – The counter-clockwise angle subtended by the segment running from Runway End 1 to point 1 at  $p_{int}$ . In other words, it is the counter-clockwise angle running from the ray defined by  $p_{int}$  and Runway End 1 to the ray defined by  $p_{int}$  and point 1. Eq. 7-10 is used to determine the angle by setting Runway End 1 as point a,  $p_{int}$  as point b, and point 1 as point c.

$$\alpha = \tan^{-1} \left( \frac{(x_a - x_b)(y_c - y_b) - (y_a - y_b)(x_c - x_b)}{(x_a - x_b)(x_c - x_b) + (y_a - y_b)(y_c - y_b)} \right) \quad \text{Eq. 7-10}$$

**Maximum Exit Speed** – The maximum exit speed of a network path is defined as the speed of the link that corresponds to movement from the first to second node in the network path. This corresponds to the network link whose endpoints are  $p_{int}$  and point 1.

When multiple inbound taxipaths are defined for a single runway end/gate combination, the three exit properties are used as the basis for selection of a network path in the sequencing algorithm for an arrival air operation with that same specific runway-end/gate combination.

## 7.4 Air Operation Scheduling

AEDT allows users to specify air operations for which ground movements will be computed in one of two ways:

1. Operational-Profile Operations: A single air operation is used to specify a larger number of operations (in annual total) which are expanded using operational profiles. The operation time for each operation is computed by AEDT.
2. Explicit Operations: Each air operation is explicitly specified by the user. The operation time for each operation is provided by the user.

The delay-and-sequencing algorithm processes sets of air operations one day at a time. A day is defined as a full, 24-hour calendar date. All air operations occurring within one day are grouped together. Each such grouping is referred to as a schedule.

Air operations defined using operational profiles require further processing that will assign operation times and runway ends to each expanded operation. The intermediate state in which the air operations that make up a schedule are not fully defined is referred to as a pseudo-schedule. AEDT assigns these values using pseudorandom processes. Operation times are generated using operational profiles. An expanded operation's operation time is randomly distributed within the quarter-hour it occurred in. Runway ends are assigned using the probability distributions provided in the active airport operating configuration for the hour-of-day in which each respective expanded air operation occurs. While operation times and runway end assignments are randomized, the random algorithm seed value is preserved so that the results are repeatable. The following sections describe the procedure used to resolve a pseudo-schedule into a fully-defined schedule.

### 7.4.1 Pseudorandom Number Generation

AEDT generates the pseudorandom numbers necessary for computing operation times and runway end assignments by employing the *rand()* (obtain a random number) and *srand()* (specify the random number generation seed) functions defined in the *rand.c* file of Microsoft's Visual Studio implementation of the standard C language library. The algorithm is a linear congruential generator (LCG) which produces integer values between 0 and 32,767, inclusive.

To yield pseudorandom floating point numbers between two given floating point bounds, *a* and *b*, inclusive, Eq. 7-11 is used by AEDT.

$$R = a + (b - a) \left( \frac{r}{2^{15} - 1} \right) \quad \text{Eq. 7-11}$$

where

- |          |   |
|----------|---|
| <i>R</i> | The scaled pseudorandom number;                               |
| <i>a</i> | The lower bound, a floating point number;                     |
| <i>b</i> | The upper bound, a floating point number; and                 |
| <i>r</i> | A new random number obtained from the <i>rand()</i> function. |

### 7.4.2 Pseudo-schedule Generation

This section outlines the process used to generate a pseudo-schedule for air operations using operational profiles. Pseudo-schedules are generated one day at a time. It is essential to keep track of the total number of operations flown on all previous days for each aircraft throughout the process to ensure that the total number of operations for each aircraft during the analysis year of the metric result equals the values specified for each air operation by the user.

The process below for generating a pseudo-schedule is applied by AEDT in a case-based sequence; this means that each case is considered differently by the pseudorandom number generation process described above. If all the operations within a job are contained within a single case, then the entire pseudo-schedule is generated all at once by the process just below. If there are multiple cases in a job, the quarter-hour pseudo-schedule is generated for each case sequentially with different pseudorandom numbers used for each case.

The following outline describes the step-by-step process used to generate a pseudo-schedule.

1. Delete all flight operations from the pseudo-schedule for the current day.
2. Let  $f_a$  be the number of operations of type  $p$  for air operation  $a$  that are carried over from the previous day. This is equal to zero for the first day.
3. Determine the month  $m$  and day of the week  $d$  for the current day of the analysis year using the Gregorian calendar.
4. For each air operation  $a$ ,
  - a) For each quarter-hour  $q$  of the current day,
    - a.1. Let  $n_{m,d,q,a}$  be the number of operations flown by air operation  $a$  during a quarter-hour  $q$  (see Eq. 7-12).
  - b) Let  $T_a$  equal the sum  $\sum_{q=1}^{96} n_{m,d,q,a}$ .
  - c) For each quarter-hour  $q$  of the current day,
    - c.1. Multiply  $n_{m,d,q,a}$  by  $\left(1 + \frac{f_a}{T_a}\right)$ .
  - d) For each quarter-hour  $q$  of the current day,
    - d.1. Let  $f_a = 0$ .
    - d.2. Insert  $\lfloor n_{m,d,q,a} \rfloor$  operations (i.e., the largest integer  $\leq n_{m,d,q,a}$ ) into the schedule to occur during  $q$ .
    - d.3. Increment  $f_a$  by the fraction  $(n_{m,d,q,a} - \lfloor n_{m,d,q,a} \rfloor)$ .
    - d.4. Subtract  $\lfloor n_{m,d,q,a} \rfloor$  from  $n_{m,d,q,a}$ , leaving the fraction only.
  - e) For each integer 1 through  $\lfloor f_a \rfloor$ , inclusive,
    - e.1. Generate a random number,  $r$ , from a uniform distribution between 0 and  $f_a - \lfloor f_a \rfloor$ , inclusive, using the pseudorandom algorithm of Eq. 7-11.
    - e.2. Let  $q$  be the first quarter-hour such that  $r \leq \sum_{i=1}^q n_{m,d,q,a}$ .
    - e.3. Insert one operation into the schedule to occur during  $q$ .
  - f) Subtract  $\lfloor f_a \rfloor$  from  $f_a$ , leaving the fraction only.

- g) Generate a random number,  $r$ , from a uniform distribution between  $10^{-6}$  and 1, inclusive, using the pseudorandom algorithm of Eq. 7-11.
- h) If  $r \leq f_a$ ,
- h.1. Generate a random number,  $r$ , from a uniform distribution between 0 and  $f_a - \lfloor f_a \rfloor$ , inclusive, using the pseudorandom algorithm of Eq. 7-11.
  - h.2. Let  $q$  be the first quarter-hour such that  $r \leq \sum_{i=1}^q n_{m,d,q,a}$
  - h.3. Insert one operation into the schedule to occur during  $q$ .
  - h.4. Subtract 1 from  $f_a$  which could make  $f_a$  negative, but  $-1 < f_a < 1$ .

The number of air operations in a given quarter-hour is calculated using the equation:

$$n_{m,d,q,a} = n_{peak,a} W_{m,a} W_{d,a} W_{q,a} \quad \text{Eq. 7-12}$$

where

- $n_{m,d,q,a}$  The number of operations flown by air operation  $a$  during quarter-hour  $q$  on day  $d$  in month  $m$ ;
- $n_{peak,a}$  The peak number of operations flown by air operation  $a$  during any quarter-hour;
- $W_{m,a}$  The weight for month  $m$  of the operational profiles assigned to air operation  $a$ ;
- $W_{d,a}$  The weight for day  $d$  of the operational profiles assigned to air operation  $a$ ; and
- $W_{q,a}$  The weight for quarter-hour  $q$  of the operational profiles assigned to air operation  $a$ .

### 7.4.3 Schedule Generation

Once all air operations for a specific day have been gathered into a fully-defined schedule, delay-and-sequencing calculations are performed in two distinct steps:

1. The delay model, Worldwide Logistics Management Institute Network Queuing Model (WWLMINET), is used to determine, for each air operation, a (one-hour) time bin when the operation is released as well as several average delay times acquired during each (one-hour) time bin. These average delay times are outputs from WWLMINET (denoted as the Delay Model in Figure 7-12).
2. The sequencing model distributes departures and arrivals to manage the state of different queues along the network links generated by the taxi network analysis (denoted as the Sequencing Model in Figure 7-12). This model is used to determine, for each air operation, exact time instances when it reaches each node in the taxi network along its taxipath. Having assigned a gate–runway pair to an air operation is a prerequisite for a taxipath assignment.

Four distinct data sets are used to model airside aircraft movements: (see Figure 7-12)

- The air operations in a schedule;
- Results of a taxi network analysis;
- Airport configurations; and
- Weather data (either hourly-weather data or average airport weather).

For each air operation, WWLMINET determines the hourly bin in which the operation is released. This is performed by running the air operations within each hourly time bin through WWLMINET, one hour at a time. WWLMINET takes into account airport configurations (how the facility is operated and its capacity) and weather conditions in doing so. Under busy airport conditions, the hourly time bin at which an air operation is determined to occur by WWLMINET can be temporally later than the hourly bin originally requested by that air operation. Under such a situation, the air operation is considered to be delayed.

Air operations are then distributed along taxipaths and runways in space and time. A detailed description of the sequencing model is provided in Section 7.6.

The process depicted in Figure 7-12 produces two distinct types of results: airport-level and operation-level results. In addition to potentially shifting operations from one hourly time bin to a later one, WWLMINET produces summed totals for the amount of delay accrued by all air arrival and departure air operations within an hourly time bin in a schedule. These delay results can be considered airport-level results since they apply to all air operations tied to a particular airport. The sequencing model produces operation-level results. Each air operation which has taxipath assigned will move along nodes defined by the taxi network from its corresponding gate to runway-end (or vice-versa). The sequencing model will calculate the time stamps at which each air operation traversed the nodes that define its corresponding taxipath.

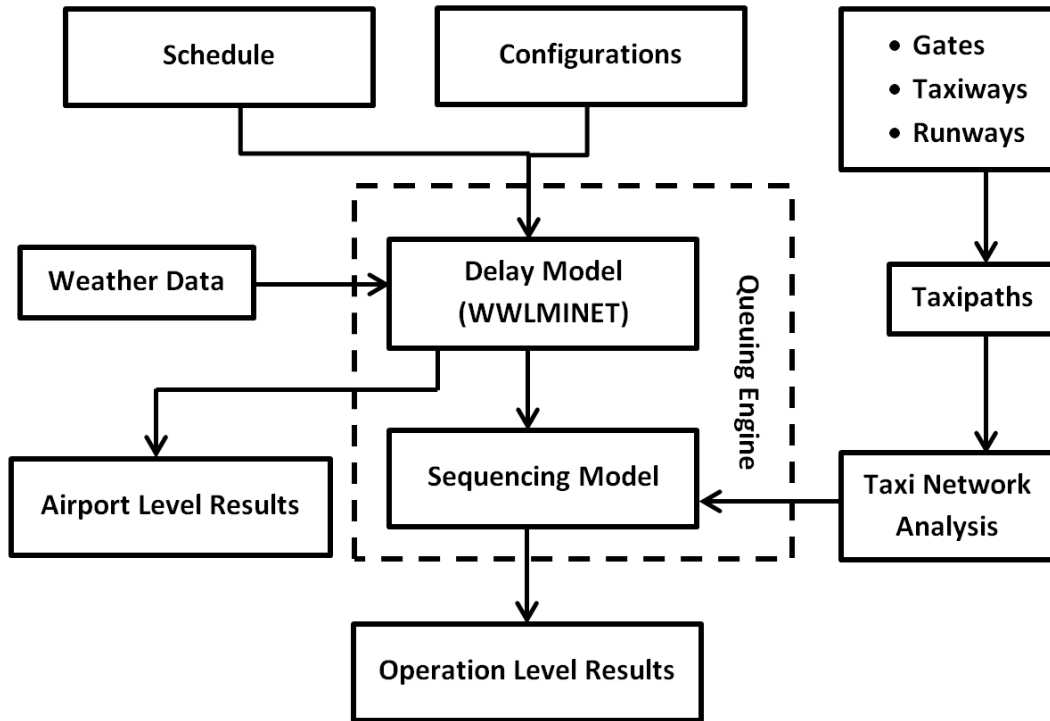

Figure 7-12 Data Flow of the Delay-and-Sequencing (Queuing) Algorithm

### 7.5 Delay Model

Airport delay is modeled by using the WWLMINET model. WWLMINET produces delay results by using the queuing network shown in Figure 7-13.



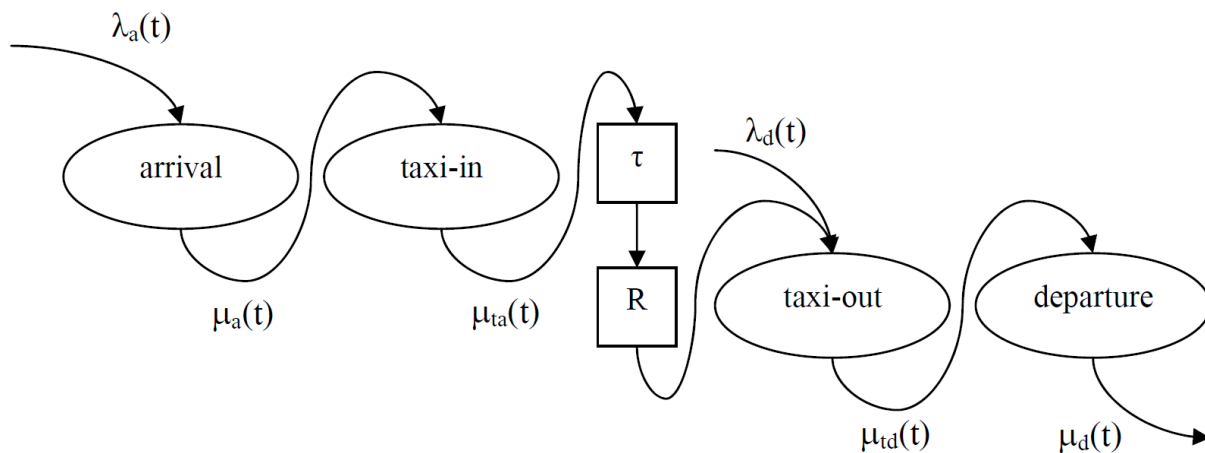

Figure 7-13 Airside Queueing Model within WWLMINET

Two queuing processes are depicted in Figure 7-13: one for arrivals and another for departures. The arrival and departure processes are not independent, and a departure may be released only if there is an available air operation in the reservoir (R). Arriving air operations enter the arrival queue as Poisson process with parameter  $\lambda_a(t)$ . After being processed by the arrival server, an arriving air operation enters the taxi-in queue. Upon processing by the taxi-in server, arriving air operations are delayed for a service time ( $\tau$ ) and released into the reservoir (R).

Departing air operations are processed by two servers as well. The departure process is driven by not only a Poisson process with parameter  $\lambda_d(t)$ , but also the state of the reservoir (R). The reservoir balances the total number of arrivals and departures over time. After being processed by the taxi-out server, departure air operations enter the departure queue and, after processing, are released.

Arrival and departure servers may be modeled as M/M/1 or M/Ek/1<sup>xxxviii</sup> queues. Taxi times (both taxi-in and taxi-out) may be modeled as M/M/1 queues only. Arrival  $\lambda_a(t)$  and departure  $\lambda_d(t)$  demands are determined directly from the schedule. The arrival and departure service rates are determined by taking into account the appropriate airport capacity Pareto frontier (Figure 7-14) based on the hourly surface weather observations.

<sup>xxxviii</sup> The A/B/c queuing system notation (Kendall's notation) provides characteristics of the arrival process (A), the service process (B), and the number of servers (c). The codes used for A and B are: M – "Markovian" characterized, among the others, with exponential distribution of inter-arrival or service times, Ek – Erlang distributed inter-arrival or service times.

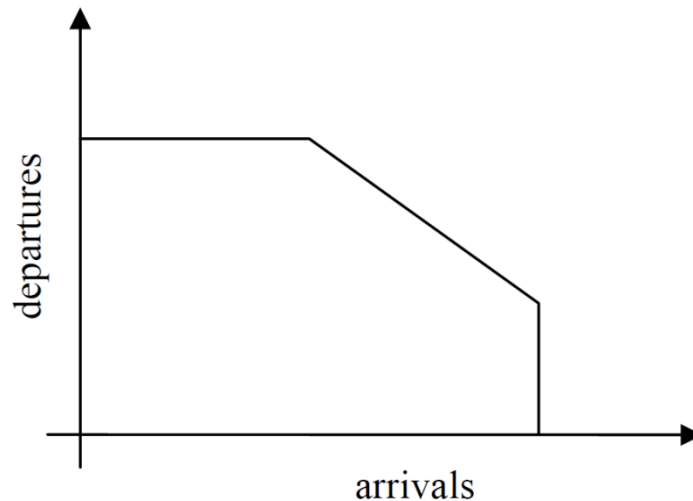

Figure 7-14 Airport Configuration Capacity Pareto Frontier

WWLMINET has a limited ability to handle taxi-in and taxi-out queuing. The model allows taxi-in and taxi-out capacities to be considered as constant values over time only.

Eq. 7-13 presents the average amount of time arrival and departure operations (within a single hourly-time bin) spend performing taxi movements and the delay sustained performing those movements. The total taxi time for a single air operation can be defined to be the following:

- The duration it takes to move unimpeded along the taxiways;
- The amount of time it sits idly (without moving) along the taxiways; and
- The amount of time it sits idly at a runway end (for departures) or the airborne delay it incurs (for arrivals).

Thus, for each hourly time bin within a daily schedule, the average taxi-in and taxi-out times presented in Eq. 7-13 are the sums of the three quantities identified above divided by the amount of air operations that contributed to those sums. WWLMINET does not return taxi delay times nor airborne/runway delay times for each air operation. It merely returns the summed total for all operations within an hourly time bin. Consequently, the best approximation for the taxi delay and airborne/runway delay for a single air operation is the summed quantity returned by WWLMINET divided by the amount of air operations that went into producing that summed quantity.

The delay model allows arrival and departure operations to taxi in and out unimpeded by not applying the average taxi-in/taxi-out delay times and the average airborne/runway delay times computed by WWLMINET. The delay model may delay air operations from one hourly time bin to the next as determined by WWLMiNET but does not apply other forms of delay also computed by WWLMINET.

$$\begin{aligned}\overline{t_a(t)} &= \overline{t_{u,in}} + \overline{t_{in}(t)} + \overline{t_{ad}(t)} \\ \overline{t_d(t)} &= \overline{t_{u,out}} + \overline{t_{out}(t)} + \overline{t_{dd}(t)}\end{aligned}\quad \text{Eq. 7-13}$$

where

$\overline{t_a(t)}, \overline{t_d(t)}$	The average taxi-in and taxi-out times, respectively;
$\overline{t_{u,in}}, \overline{t_{u,out}}$	The average unimpeded taxi-in and taxi-out times, respectively;
$\overline{t_{in}(t)}, \overline{t_{out}(t)}$	The average taxi-in and taxi-out delay times, respectively; and
$\overline{t_{ad}(t)}, \overline{t_{dd}(t)}$	The average airborne delay and runway delay, respectively.

## 7.6 Sequencing Model

The sequencing model distributes air operations along taxipaths and runways in space and time. The outcome is further used to distribute aircraft-based emissions along taxipaths, runways and approach/departure segments.

The operation time provided in a schedule is considered to be push-back time for departures and touch-down time for arrivals. Furthermore, WWLMINET ultimately determines the hourly time bin when the operation is released. The  $i^{th}$  operation cannot be released before time  $t_i^{ready}$  given by Eq. 7-14. The actual time instances when operations are released depend on the state of the queues and availability of the runways. These are ultimately determined by the sequencing model.

$$t_i^{ready} = \begin{cases} \max(t_i, t_i^{WWLMINET}), & \text{if } i \text{ is an arrival} \\ \max\left(\left(t_i + \sum_{j \in P_i} \frac{S_j}{v_j}\right), t_i^{WWLMINET}\right), & \text{if } i \text{ is a departure} \end{cases}\quad \text{Eq. 7-14}$$

where

$t_i^{ready}$	The earliest possible release time for operation $i$ ;
$t_i$	The time in the schedule assigned to operation $i$ ;
$t_i^{WWLMINET}$	The time when operation $i$ 's hourly time bin begins;
$P_i$	The set of all taxipath segments assigned to operation $i$ ;
$S_j$	The length of taxipath segment $j$ ; and
$v_j$	The speed assigned to taxipath segment $j$ .

Since the airborne delay (the output of WWLMINET) occurs at altitudes higher than 3,000 ft AFE, AEDT will not model the emissions resulting from the aircraft spending more time in the air, and the approach from 3,000 ft to the ground will be continuous without any delay during this segment. Additionally, to simplify the model, taxi-in and taxi-out operations are considered to be uninterrupted (unimpeded).

The sequencing model distributes operations among the runways and taxiways following the taxi network as defined by the user and the analysis performed by the taxi network analysis algorithm. Queues are generated starting at each runway entrance (runway nodes) and grow along the individual

taxiways as more aircraft are delayed. Each air operation will experience at most one queue on taxi out and will take off immediately after exiting the queue.

Initially, all queues are assumed to be empty. The sequence of air operations entering the departure queues is determined based on the gate pushback time and the time it takes the air operation to taxi to the queue. The taxi time is determined based on speed and length of the network links that make up the air operation’s network path, without taking into consideration motion dynamics. The length (in terms of distance) of the queue itself is determined based only on the average space occupied by each air operation and the number of air operations in the queue. The average space that each air operation will occupy (regardless of aircraft size), including buffer spacing between two successive air operations, will be 150 ft (as defined in Section 7.3.2.9.2 of the Taxi Network algorithm).

The exact time when an air operation is allowed to takeoff/land depends on runway occupancy times for arriving and departing operations on the same runway. Additionally, the takeoff time depends on the state of the queue the air operation joins before it is allowed to enter the runway for takeoff. The exact time when an aircraft is allowed to takeoff/land is expressed in Eq. 7-15:

$$t_i^{release} = \begin{cases} \max(t_i, t_i^{WWLMINET}, t_{r_i}^{OUT}), & \text{if } i \text{ is an arrival} \\ \max\left(t_i + \sum_{j \in P_i} \frac{S_j - S_j^{queue}}{v_j} + \sum_{j \in A_i} t_j^{ROT}, t_i^{WWLMINET}\right), & \text{if } i \text{ a departure} \end{cases} \quad \text{Eq. 7-15}$$

where

$t_i^{release}$	The actual release time for operation i;
$t_i$	The time in the schedule assigned to operation i;
$T_i^{WWLMINET}$	The time when operation i’s hourly time bin begins;
$t_{r_i}^{OUT}$	The “occupied until time” (OUT) of runway $r_i$ ;
$r_i$	The runway assigned to operation i;
$P_i$	The set of all taxipaths segments assigned to operation i;
$S_j$	The length of taxipath segment j;
$S_j^{queue}$	The queue length along taxipath segment j at the time i joins the queue;
$v_j$	The speed assigned to taxipath segment j;
$A_i$	The set of air operations (arrivals, departures, TGOs) on runway $r_i$ which occur after the air operation i joins the queue and before the operation i reached the front of the queue; and
$t_j^{ROT}$	The runway occupancy time of operation j determined by resolving the flight profile of operation i.

All arrivals are allowed to taxi in unimpeded without any queue formation. The sequence of arriving aircraft is predominantly determined based on the scheduled arrival times. The release time for arrivals  $t_i^{release}$  could be slightly later or equal to  $t_i^{ready}$ .

Touch-and-Go operations (TGO) are considered similarly to arrivals. These operations occupy their designated runways for the period of time determined by resolving their procedural profile. Unlike arrival operations, TGOs do not occupy any taxiway segment for any period of time.

Under a single runway configuration, any runway could be used for both arrivals and departures. Therefore, while considering a single runway resource, competing requests may appear (e.g., more than one departure queue and a stream of arrivals could exist as in Figure 7-15). Among all operations requesting service, the sequencing model releases the first one based on the time of the request.

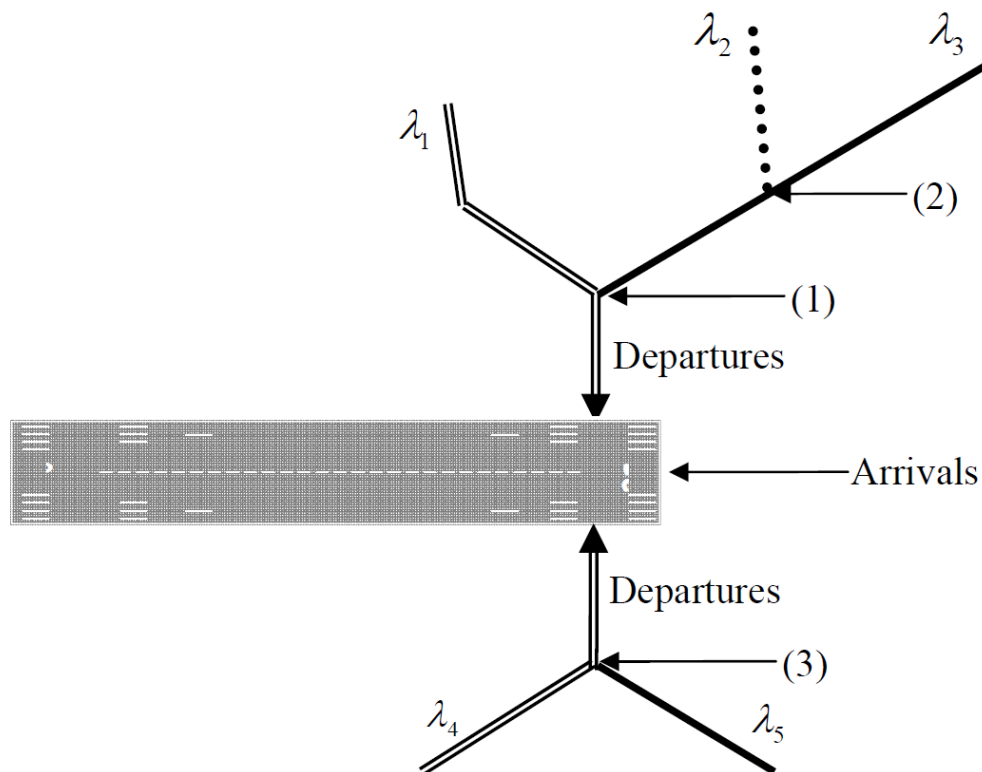

Figure 7-15 Example of a Runway End Serving Traffic from Several Queues

With the assumption that there is no priority between the different departure paths, the queues propagate according to arrival rates. For example, in Figure 7-15, once the queue exceeds node 1, it will branch along the paths proportionally according to the arrival rates  $\lambda_1$  and  $\lambda_2 + \lambda_3$ .

When a departure operation is released (e.g., from the taxiway segment that links node 1 to the runway-end in Figure 7-15), the sequencing model updates queues such that all air operations waiting on the link (node 1, runway-end) are moved forward. If the queue is beyond node 1, a new operation will be inserted into the link. This operation is selected based on the length of the queues on individual branches. The branch with the longest queue gets service priority. Continuing with the example, let us assume that the longer queue exists on the branch that uses node 2. Thus, now the first aircraft waiting

on the link (1, 2) gets inserted into the link (node 1, runway-end) and all aircraft on the link (1, 2) are moved forward. If this queue propagates beyond node 2, a new branch is formed and the procedure is repeated.

An operation (departure/arrival) may be released only when its assigned runway is not occupied. Thus, each active runway needs to be characterized by an “occupied until time” (OUT) property which is updated every time an operation is released. All runways that have operations in queues are sorted by ascending order of their respective OUTs. The first runway in this list is the next one to have an operation released as given by Eq. 7-16.

$$r = \arg \min_{i \in R} (t_i^{OUT}) \quad \text{Eq. 7-16}$$

where

$r$  The next runway to release an operation at any given time;  
 $R$  The set of all runways; and  
 $t_i^{OUT}$  The OUT of runway  $i$ .

The sequencing algorithm performs a simplistic discrete-event simulation of airport operations. Arrival and departure operations are injected into the simulation at the time given by Eq. 7-17.

$$t_i^{inj} = \begin{cases} \max(t_i, t_i^{WWLMINET}) & \text{if } i \text{ is an arrival} \\ t_i & \text{if } i \text{ is a departure} \end{cases} \quad \text{Eq. 7-17}$$

where

$t_i^{inj}$  The injection time of operation  $i$ ;  
 $t_i$  The time in the schedule assigned to operation  $i$ ; and  
 $t_i^{WWLMINET}$  The time when operation  $i$ 's hourly time bin begins.

All queues are updated every time a new operation is injected into the system. This means that the procedure for releasing departure operations described above is repeated until the OUT is later than  $t_i^{inj}$ , or there are no operations in any queue for any active runway. This terminating condition is summarized by Eq. 7-18. When Eq. 7-18 is true, no more departures are released.

$$N = \sum_{r \in R} \begin{cases} 1, & \text{if } t_i^{inj} \leq t_r^{OUT} \text{ or } n_r = 0 \\ 0, & \text{otherwise} \end{cases} \quad \text{Eq. 7-18}$$

where

$N$  The number of active runways;  
 $R$  The set of all runways;  
 $T_i^{inj}$  The injection time of operation  $i$ ;

$T_r^{OUT}$	The OUT of runway $r$ ; and
$n_r$	The number of operations in the queue(s) feeding runway $r$ .

The states of all queues are repeatedly updated before another operation is injected into the system. In some instances, due to high demand and/or low airport capacities, WWLMINET may push  $t_i^{ready}$  (and therefore  $t_i^{release}$ ) into the next day. These operations are released at the very beginning of the next day.

### 7.6.1 Sequencing Algorithm and Outputs

The sequencing model processes one day (schedule) of operations at a time immediately after the same schedule has been processed by the delay model. Overflow of operations from one day to another is released during the first hourly time bin of the next day; thus, no operations are lost. The sequencing model processing steps are:

1. Evaluate each operation  $i$  in the schedule (the operations are provided chronologically with overflow from the previous day at the beginning of the list).
  - a) Release all departures accumulated in the queues of the taxiway network until Eq. 7-18 is true.
  - b) If the operation is not intended to be released the same calendar day, then change release time of this operation to be the first hourly time bin of the next day and go to the next operation.
  - c) Inject operation  $i$  into the system.
2. If it is a departure, propagate its movement along segments of taxiways included in its taxipath until it reaches a queue or runway-end. It will unimpededly reach a runway-end if it encounters no queues.
3. If it is an arrival, propagate the operation along the corresponding inbound taxipath. Arrival movements are considered to be unimpeded.
4. If there are operations for which release time will pass beyond the end of the metric result, change the release time of these operations to the last hourly bin of the metric result and release them all.

The ultimate result of sequencing (which itself depends on the delay model) is, for each air operation, a list of 4-dimensional points which constitute a path followed by the air operation from its corresponding gate/runway-end pair.

This 4-dimensional path is used to produce a taxi trajectory segment for each node-to-node movement specified by the path produced by the sequencing algorithm. A fuel flow rate is computed for the sequenced taxi trajectory segments. The fuel flow rate during taxiing is derived using a modified instance of unadjusted idle engine configuration. The calculation of this fuel flow Rate per engine ( $f$ ) is shown in Eq. 7-19.

$$f = \frac{1.1 \cdot UA_{ID} \cdot \delta}{\theta^{3.8}} \quad \text{Eq. 7-19}$$

where

- f        The fuel flow rate per engine of a sequenced taxi trajectory segment (kg/s);  
UA<sub>ID</sub>    The unadjusted idle fuel flow rate of the operation's engine (kg/s);  
δ        The pressure ratio at the initial time and initial location of the sequenced taxi trajectory segment; and  
θ        The temperature ratio at the initial time and initial location of the sequenced taxi trajectory segment.

The total fuel burn for each sequenced taxi trajectory segment is computed using Eq. 7-20.

$$F = f \cdot \Delta t \cdot n_{\text{eng}} \quad \text{Eq. 7-20}$$

where

- F        The total fuel burned by a sequenced taxi trajectory segment (kg);  
Δt       The duration of a sequenced taxi trajectory segment (s); and  
N<sub>eng</sub>    The total number of engines of the operation's aircraft (ANP aircraft).

AEDT calculates the emissions resulting from this fuel burn. When calculating emissions dispersion, AEDT synthesizes the resulting emissions and localizes them along the taxiways computed by the taxi network analysis. The localized emissions are then utilized to produce dispersion sources.



---

## 8. Annualization

### 8.1 Overview

In AEDT, an annualization is a hierarchical grouping of operations associated with the following parameters:

- Time period to be analyzed.
- Operations included in the time period.
- Weighted groupings of the included operations.
- Modeling options for the included operations.

The main steps in creating an annualization are provided below. (For more detailed instructions on creating an annualization in the AEDT Graphical User Interface, refer to the AEDT User Manual<sup>1</sup>).

1. Create operation groups (or select existing operation groups).
2. Create the annualization hierarchy and apply a weighting scheme.

AEDT allows the user the flexibility to create annualization through the user interface, via ASIF or directly in the SQL database.

#### Operation Groups and Annualization Hierarchy

An operation group (referenced as a “case” in the AEDT STUDY database and in ASIF) represents a collection of operations. When creating operations groups, it is important to plan the final annualization hierarchy. The annualization hierarchy allows for organization and grouping of operations so that the user can easily reuse operation groups to evaluate different scenarios (baseline and alternatives). Once operation groups are created, they can be reused (without changes) in additional annualizations.

An example of a simple annualization hierarchy in general terms is as follows:

- Root annualization
  - Operation group A
  - Operation group B
  - Operation group C

An example of a simple annualization hierarchy in the context of a possible study is as follows:

- Baseline annualization
  - Operation group: Large aircraft
  - Operation group: Medium aircraft
  - Operation group: Small aircraft

A nested annualization hierarchy can be created by grouping operating groups. A sample of a more complex annualization hierarchy in general terms is as follows:

- Root annualization
  - Group 1
    - Operation group A
    - Operation group B
  - Group 2
    - Operation group C
    - Operation group D

---

An example of a nested annualization hierarchy in the context of a possible study is as follows:

- Baseline annualization
  - North-East Configuration
    - Operation group: Approach operations
    - Operation group: Departure operations
  - South-West Configuration
    - Operation group: Approach operations
    - Operation group: Departure operations

### Annualization Weighting Scheme

The process of performing a weighted aggregation over the noise and emissions results from operation groups allows for generating results that represent noise and emissions exposures over the time period of interest. Depending on the data represented by the operation groups and the time period of the results, annualized results can be computed by applying a user-defined weighting scheme. The user must specify annualization weighting factors for each operation group included in the annualization.

The weighting scheme includes two types of multipliers known as the annualization weight and the scaling factor. The annualization weight is a multiplication factor that is typically between zero and one representing percentage use. The scaling factor is used to scale operations up and down and therefore can be a number greater or less than 1. Both annualization weights and scaling factors are applied to individual operation groups as well as groupings of operation groups.

An example of a simple annualization hierarchy with annualization weights (AW) and scaling factors (SF) is as follows. Note that the final weighting that is applied to the operation group is the product of the weighting defined at the operation group level and the root annualization level. Refer to the Annualization Equations section for more information on how weightings are applied.

- Root annualization (AW = 1, SF = 1)
  - Operation group A (AW = 0.50, SF = 1)
  - Operation group B (AW = 0.25, SF = 1)
  - Operation group C (AW = 0.25, SF = 1)

In the example above, the annualization consists of three groups – A, B, and C with annualization weights of 0.50, 0.25 and 0.25, respectively – then these weights indicate that group A occurs 50% of the year and groups B and C each occur 25% of the year. Note that the scaling factor is 1 so it is not scaling the operations up or down. For studies requiring the evaluation of metrics on a yearly or average annual day basis, annualization weights must be set such that cumulative weightings represents the appropriate annualized distribution over the average annual day.

A scale factor is used to modify the number of operations. For example, the user may apply a scale factor of 2.0 to an individual operation group to model a scenario where the number of operations in that operation group may double in a future scenario.

- Root annualization (AW = 1, SF = 1)
  - Operation group A (AW = 0.50, SF = 2)
  - Operation group B (AW = 0.25, SF = 1)
  - Operation group C (AW = 0.25, SF = 1)

In this example, the existing weighting for operation group A would be multiplied by 2.0 to provide the final annualization weight.

In the case of a nested annualization, annualization weights and scaling factors can be applied at each level of organization. Note that the final weighting that is applied to the operation group is the product of the weighting defined at the operation group level, group level, and the root annualization level. For example, including a scaling factor of 2 at Group 1, also impacts the final weighing of the operations below Group 1. Refer to the Annualization Equations section for more information on how weightings are applied.

- Root annualization (AW = 1, SF = 1)
  - Group 1 (AW = 1, SF = 2)
    - Operation group: A (AW = 1, SF = 1)
    - Operation group: B (AW = 1, SF = 1)
  - Group 2 (AW = 1, SF = 1)
    - Operation group: A (AW = 1, SF = 1)
    - Operation group: B (AW = 1, SF = 1)

An example of a nested annualization hierarchy with annualization weights and scaling factors in the context of a possible study is as follows:

- Baseline annualization (AW = 1, SF = 1)
  - North-East Configuration (AW = 0.7, SF = 2)
    - Operation group: Approach operations (AW = 1, SF = 1)
    - Operation group: Departure operations (AW = 1, SF = 1)
  - South-West Configuration (AW = 0.3, SF = 1)
    - Operation group: Approach operations (AW = 1, SF = 1)
    - Operation group: Departure operations (AW = 1, SF = 1)

It is important to note that the scale factor is not specified separately when defining an annualization through the AEDT Graphical User Interface. If it is desired to use an annualization weight and a scaling factor, user must input the product of the annualization weights and scaling factor for each annualization component. Annualization weights and scaling factors can be defined separately when defining annualizations through the ASIF (see the ASIF Reference Manual<sup>24</sup>) or directly in the SQL database.

### Annualization Equations

In its simplest form, an annualization may be depicted in the following equation:

$$A(s) = \sum_c R(c, w) \quad \text{Eq. 8-1}$$

where

- |        |   |
|--------|---|
| A(s)   | Annualized result for scenario, s; and                            |
| R(c,w) | Result for each operation group (case), c, weighted by weight, w. |

The final annualization weight for each operation group,  $FAW(c)$ , is an aggregate factor that encompasses the annualization weights of all parent groups in the operation group's hierarchy – including the final annualization weight:

$$FAW(c) = AW(c) \times FAW(pg) \quad \text{Eq. 8-2}$$

where

- $AW(c)$  Annualization weight for the operation group; and
- $FAW(pg)$  Final annualization weight for the operation group's parent group.

Similarly, the final scale factor for each operation group,  $FSF(c)$ , is an aggregate factor that encompasses the scale factors of all parent groups in the operation group's hierarchy – including the final scale factor:

$$FSF(c) = SF(c) \times FSF(pg) \quad \text{Eq. 8-3}$$

where

- $SF(c)$  Scale factor for the operation group; and
- $FSF(pg)$  Final scale factor for the operation group's parent group.

The final weight applied at each operation group,  $w(c)$ , is the aggregate weight that is a combination of the annualization weight and the scale factor:

$$w(c) = FAW(c) \times FSF(c) \quad \text{Eq. 8-4}$$

where

- $FAW(c)$  Final annualization weight for the operation group; and
- $FSF(c)$  Final scale factor for the operation group.

For example, given the following hierarchy of user-specified annualization weights,  $AW$ , and scale factors,  $SF$ :

- Root Annualization ( $AW=1.0$ ,  $SF=1.0$ )
  - Group 1 ( $AW=0.9$ ,  $SF=1.0$ )
    - Operation group ( $AW=0.5$ ,  $SF=2.0$ )

the final weight for the operation group,  $w(c)$ , is computed as:

$$\begin{aligned} FAW(c) &= (0.5 \times 0.9 \times 1.0) = 0.45 \\ FSF(c) &= (2.0 \times 1.0 \times 1.0) = 2.0 \\ w(c) &= 0.5 \times 2.0 = 1.0 \end{aligned}$$

If the final weight ( $w$ ) for an operation group is computed to be zero, then the annualization will still proceed but the operation group will be omitted from the final annualized result (that operation group occurs 0% of the year). If an operation group that is included in an annualization tree does not have any valid results, the annualization will not proceed and an error will be logged.

When applied to emissions, the weight for each operation group is a simple multiplier on the operation group-level emissions results. When applied to noise results at receptors, the weight for each operation group is a simple multiplier on the total acoustic energy at each point, which in effect scales the number of operations for the entire operation group.

## 8.2 Peak Month Average Day and Annual Average Day Annualizations

This section describes how average annual day (AAD) and peak month average day (PMAD) can be calculated from an annual schedule which often represents the baseline for a given analysis. Alternative scenarios can be evaluated by adjusting the values to reflect other potential scenarios.

For certain analyses, operations must be entered as specified in AEDT based on an average annual day (AAD). To determine the AAD from an annual schedule, the typical procedure encompasses two steps:

1. Add the number of operations for like entries in the annual schedule. Like entries can encompass a number of groupings such as type of aircraft, aircraft category (commercial air carrier, air taxi, general aviation, military), operation type, track, and time of day (daytime 0700-2200 hours local and nighttime 2200-0700 hours local).
2. After like entries are added, the total is divided by 365 for each remaining entry to represent an average day of operations in the year.

A Design Day Ratio (also known as PMAD scaling factor) is needed to create an aircraft emissions inventory. To identify the Design Day Ratio:

1. Determine the month with the most operations (i.e., peak flights) for the year.
2. Compute the average daily operations for that month (i.e., the PMAD operations):  
$$\text{PMAD} = \# \text{ Operations in the month with the Most Operations} / \# \text{ Days in that Month}$$
3. Compute the AAD number of operations for the year:  
$$\text{AAD} = \text{Total \# Operations in the Year} / \# \text{ Days in that Year}$$
4. Compute the Design Day Ratio:  
$$\text{Design Day Ratio} = \text{PMAD}/\text{AAD}$$

### 8.2.1 Annual Average Day and Design Day Ratio Calculation Example

For this example, assume that the schedule in Table 8-1 represents a full year for a single, fictional airport. For this fictional airport, there is one arrival runway end, two types of aircraft, and a very limited schedule.

Table 8-1 Full Example Schedule for the Year 2019

FLIGHT_MONTH	ARR_DATE	ARR_TIME	ACTYPE	ENG_CODE	ARR_RWY_END
1	1/1/2019	10:42	B737-8	8CM051	10R
1	1/10/2019	22:07	A350-9	18RR079	10R
2	2/3/2019	8:00	B737-8	8CM051	10R
2	2/25/2019	11:42	B737-8	8CM051	10R
3	3/11/2019	17:05	A350-9	18RR079	10R
3	3/30/2019	18:48	B737-8	8CM051	10R
4	4/2/2019	21:06	A350-9	18RR079	10R
4	4/8/2019	23:45	A350-9	18RR079	10R
5	5/12/2019	1:00	B737-8	8CM051	10R
5	5/20/2019	13:05	B737-8	8CM051	10R
6	6/4/2019	8:40	A350-9	18RR079	10R
6	6/11/2019	9:59	A350-9	18RR079	10R
6	6/25/2019	21:26	B737-8	8CM051	10R
7	7/3/2019	23:58	B737-8	8CM051	10R
7	7/6/2019	2:30	B737-8	8CM051	10R
7	7/24/2019	6:56	B737-8	8CM051	10R
8	8/1/2019	6:59	A350-9	18RR079	10R
8	8/13/2019	11:09	A350-9	18RR079	10R
8	8/20/2019	22:54	B737-8	8CM051	10R
8	8/22/2019	23:21	B737-8	8CM051	10R
9	9/2/2019	15:01	B737-8	8CM051	10R
9	9/15/2019	17:08	A350-9	18RR079	10R
10	10/8/2019	17:52	B737-8	8CM051	10R
10	10/19/2019	18:42	A350-9	18RR079	10R
11	11/20/2019	19:45	B737-8	8CM051	10R
11	11/24/2019	13:00	A350-9	18RR079	10R
11	11/26/2019	16:32	A350-9	18RR079	10R
12	12/20/2019	7:29	A350-9	18RR079	10R
12	12/21/2019	11:05	A350-9	18RR079	10R
12	12/27/2019	23:00	B737-8	8CM051	10R

### 8.2.1.1 Average Annual Day

1. The number of operations from the full schedule (Table 8-1) are combined for the same type of aircraft, by time of day (daytime 0700-2200 hours local and nighttime 2200-0700 hours local) (Table).
2. The total number of operations for each grouping is divided by 365 to represent an average day of operations of that type in the year (Table 8-2).

Table 8-2 Like Entries Combined, Average Annual Day

ARR_TIME	ACTYPE	ENG_CODE	ARR_RWY_END	NUM_OPS	AAD_NUM_OPS
Day	B737-8	8CM051	10R	12	0.032876712
Night	B737-8	8CM051	10R	4	0.010958904
Day	A350-9	18RR079	10R	12	0.032876712
Night	A350-9	18RR079	10R	2	0.005479452

### 8.2.1.2 Design Day Ratio

1. The month with the most operations for the year is August (8).
2. The average daily operations for that month (i.e., the PMAD operations):

$$\text{PMAD} = \# \text{ Operations in the month with the Most Operations} / \# \text{ Days in that Month}$$

$$\text{PMAD} = 4/31 = \mathbf{0.129032258}$$

3. The AAD number of operations for the year:

$$\text{AAD} = \text{Total \# Operations in the Year} / \# \text{ Days in that Year}$$

$$\text{AAD} = 30/365 = \mathbf{0.082191781}$$

4. The Design Day Ratio:

$$\text{Design Day Ratio} = \text{PMAD}/\text{AAD}$$

$$\text{Design Day Ratio} = 0.129032258 / 0.082191781 = \mathbf{1.569892473}$$

## 9. Change Analysis and Impact Evaluation

### 9.1 Change Analysis

This section describes statistical and summary calculations performed by the change analysis functionality in AEDT.

#### 9.1.1 Change Analysis Report Statistics

The requirements to run change analysis are as follows:

- Two different annualizations run with the same receptor set;
- Metric results must be run with the DNL noise metric; and
- The metric results used must have been run through to successful completion.

The change analysis report performs two sets of calculations:

1. A threshold calculation to find the cases most responsible for the noise contributions at a given receptor point.
2. A grouping of cases and receptor points to provide the user with causality groups (or sets).

The change analysis calculations are described below.

For each receptor and case, the baseline weighted raw energy values  $BRAW(c,r)$ , see Eq. 9-1, and baseline DNL values  $BDNL(c,r)$ , see Eq. 9-2, are computed.

$$BRAW(c,r) = 10^{\left(\frac{B(c,r)}{10}\right)} \cdot AW(c) \quad \text{Eq. 9-1}$$

where

- $B(c,r)$       Baseline DNL noise for case,  $c$ , and receptor,  $r$  and  
 $AW(c)$       Final annualized weighting factor for the baseline or alternative case,  $c$ .

$$BDNL(c,r) = 10\text{Log}_{10}(BRAW(c,r)) \quad \text{Eq. 9-2}$$

Similarly, the alternative equivalents are calculated. Refer to Eq. 9-3 for the alternative weighted raw energy equation,  $ARaw(c,r)$  and Eq. 9-4 for the alternative DNL equation,  $ADNL(c,r)$ .

$$ARaw(c,r) = 10^{\left(\frac{A(c,r)}{10}\right)} \cdot AW(c) \quad \text{Eq. 9-3}$$

where

- $A(c,r)$       Alternative DNL noise for case,  $c$  and receptor,  $r$ .

$$ADNL(c,r) = 10\text{Log}_{10}(ARAW(c,r)) \quad \text{Eq. 9-4}$$

Next, the total RAW and DNL values are computed for each receptor, See Eq. 9-5 through Eq. 9-8.



$$BRAW(r) = \sum_c BRAW(c, r) \quad \text{Eq. 9-5}$$

$$BDNL(r) = 10\text{Log}_{10}(BRAW(r)) \quad \text{Eq. 9-6}$$

$$ARAW(r) = \sum_c ARAW(c, r) \quad \text{Eq. 9-7}$$

$$ADNL(r) = 10\text{Log}_{10}(ARAW(r)) \quad \text{Eq. 9-8}$$

Then, the total differences  $DRAW(c, r)$ ,  $DDNL(c, r)$ ,  $DRAW(r)$ , and  $DDNL(r)$  are computed, see Eq. 9-9 through Eq. 9-12.

$$DRAW(c, r) = BRAW(c, r) - ARAW(c, r) \quad \text{Eq. 9-9}$$

$$DDNL(c, r) = BDNL(c, r) - ADNL(c, r) \quad \text{Eq. 9-10}$$

$$DRAW(r) = BRAW(r) - ARAW(r) \quad \text{Eq. 9-11}$$

$$DDNL(r) = BDNL(r) - ADNL(r) \quad \text{Eq. 9-12}$$

Next, the percentage RAW difference,  $PDR(c, r)$  for each case at a given receptor is computed, see Eq. 9-13.

$$PDR(c, r) = 100 \cdot \left| \frac{DRAW(c, r)}{DRAW(r)} \right| \quad \text{Eq. 9-13}$$

The mean percentage difference for the receptor over all the case differences,  $MPDR(r)$ , is computed by Eq. 9-14.

$$MPDR(r) = \sum_c \frac{PDR(c, r)}{Nc} \quad \text{Eq. 9-14}$$

Finally, the standard deviation of the Percentage differences over all the cases,  $PSIG(r)$ , is computed by Eq. 9-15.

$$PSIG(r) = \sqrt{\sum_c \frac{(PDR(c, r) - MPDR(r))^2}{Nc}} \quad \text{Eq. 9-15}$$

Cases that have a percentage raw difference,  $PDR(c,r)$ , that is greater than the mean percentage,  $MPDR(r)$ , plus one-half the standard deviation of the percentage differences,  $PSIG(r)$ , are considered significant contributors of noise for a given receptor, see Eq. 9-16.

$$PDR(c,r) > MPDR(r) + 0.5 \cdot PSIG(r) \quad \text{Eq. 9-16}$$

After the statistics for each case and receptor have been computed, the receptors are organized into groups. Each group contains receptors that have the same set of significant case contributors as defined by Eq. 9-16, therefore changes to a given significant case will affect all the receptors in that group in a similar fashion. Both the statistical information and the grouping information are displayed in the change analysis report.

## 9.2 Impact Evaluation

The impact evaluation functionality provides the percent contribution of each flight in a given case to a selected set of receptor points (those in a change zone). Cases must be run with detailed noise (event-level noise results) before impact evaluation can be utilized. The percentage contribution calculation is described below.

The total noise,  $N(f)$ , is calculated over all the receptors in the change zone for each flight in the case, see Eq. 9-17.

$$N(f) = AW(c) \cdot \sum_r N(f,r) \quad \text{Eq. 9-17}$$

where

- $N(f,r)$  SEL noise for flight,  $f$ , at receptor,  $r$ ; and
- $AW(c)$  Final annualized weighting factor for the alternative case,  $c$ .

Next, the total noise,  $TN$ , is calculated by summing the total noise  $N(f)$  for each flight in the case, see Eq. 9-18.

$$TN = \sum_f N(f) \quad \text{Eq. 9-18}$$

Finally, the percentage noise,  $PN(f)$ , of each flight is computed by dividing each flight's noise by the total noise as shown in Eq. 9-19.

$$PN(f) = 100 \cdot \frac{N(f)}{TN} \quad \text{Eq. 9-19}$$

---

## 10. Environmental Justice Capability

### 10.1 Overview

AEDT has been augmented to be compatible with additional U.S. Census Bureau products, the American Community Survey (ACS), to identify potential environmental justice (EJ) and Limited English Proficiency (LEP) populations to assist in community outreach efforts associated with FAA actions subject to the National Environmental Policy Act (NEPA). This section describes the EJ and LEP data sources and algorithms in AEDT.

### 10.2 American Community Survey (ACS) Data

The EJ and LEP capabilities within AEDT use the U.S. Census Bureau's ACS data as the underlying demographic data for all calculations and display within AEDT. The ACS data is available in 1-year, 3-year, and 5-year estimates. ACS 5-year estimates were used because they provided the necessary demographic variables at the highest spatial resolution.

AEDT supports 2020 American Community Survey (ACS) 5-year data for the Environmental Justice analysis and 2020 ACS 5-year data for the Limited English Proficiency analysis. The 2015 ACS 5-year data is also supported for Limited English Proficiency analyses as an option as the number of language categories were consolidated in the 2020 census. For more details on the ACS data, see:

<https://www.census.gov/programs-surveys/acs>.

#### 10.2.1 Environmental Justice (EJ)

The EJ capability utilizes ACS data at the spatial resolution of block groups. Block groups are divisions of census tracts (i.e., a series of block groups make up a single census tract). They typically have a population of between 600 and 3,000 people. Block groups are further divided into blocks (i.e., a series of blocks make up a block group)<sup>xxxix</sup>.

The following demographic tables from the ACS 5-year estimates are used by the EJ capability. For more information on the ACS demographic variables used by EJ, see

<https://api.census.gov/data/2020/acs/acs5/variables.html>.

---

<sup>xxxix</sup> For more details on block groups, see: <https://www.census.gov/programs-surveys/geography/about/glossary.html>

Table 10-1 ACS Data Tables used by Environmental Justice

ACS Table	ACS Table ID
SEX BY AGE	B01001
RACE	B02001
WHITE ALONE OR IN COMBINATION WITH ONE OR MORE OTHER RACES	B02008
BLACK OR AFRICAN AMERICAN ALONE OR IN COMBINATION WITH ONE OR MORE OTHER RACES	B02009
AMERICAN INDIAN AND ALASKA NATIVE ALONE OR IN COMBINATION WITH ONE OR MORE OTHER RACES	B02010
ASIAN ALONE OR IN COMBINATION WITH ONE OR MORE OTHER RACES	B02011
NATIVE HAWAIIAN AND OTHER PACIFIC ISLANDER ALONE OR IN COMBINATION WITH ONE OR MORE OTHER RACES	B02012
SOME OTHER RACE ALONE OR IN COMBINATION WITH ONE OR MORE OTHER RACES	B02013
HISPANIC OR LATINO ORIGIN BY RACE	B03002
HOUSEHOLD LANGUAGE BY HOUSEHOLD LIMITED ENGLISH SPEAKING STATUS	C16002
MEDIAN HOUSEHOLD INCOME IN THE PAST 12 MONTHS (IN 2020 INFLATION-ADJUSTED DOLLARS)	B19013
RATIO OF INCOME TO POVERTY LEVEL IN THE PAST 12 MONTHS	C17002

**10.2.1.1 Demographic Variables used by Environmental Justice**

The EJ capability tracks a series of demographic variables. Key demographic variables include total population, minority population, population below the poverty level, population by race or ethnicity, etc. These variables can be divided into two groups:

- Variables that directly come from the ACS data tables (they may be mapped to a new name or use the variable ID); and
- Variables that are calculated from the ACS variables.

For a full list of all variables that come directly from the ACS data and variables that are calculated, see Section 10.3. The following demographic variables are calculated by the EJ capability:

$$pop_{minority} = B03002\_001E - B03002\_003E \tag{Eq. 10-1}$$

where

- pop<sub>minority</sub> Population of minorities in the block group;
- B03002\_001E Total population (ACS Table B03002); and
- B03002\_003E Population of Non-Hispanic or Latino, White alone (ACS Table B03002).

$$pop_{1xpov} = C17002\_002E + C17002\_003E \tag{Eq. 10-2}$$

where

$pop_{1xpov}$	Population below 1 times the Census poverty threshold;
C17002_002E	Population whose ratio of income to threshold is less than 0.5 (ACS Table C17002); and
C17002_003E	Population whose ratio of income to threshold is 0.5 to 0.99 (ACS Table C17002).

$$pop_{lang} = C16002_004E + C16002_007E + C16002_010E + C16002_013E \quad \text{Eq. 10-3}$$

where

$pop_{lang}$	Population that is linguistically isolated;
C16002_004E	Population of households primarily language Spanish with limited English (ACS Table C16002);
C16002_007E	Population of households primarily languages Indo-European with limited English (ACS Table C16002);
C16002_010E	Population of households primarily languages Asian and Pacific Island with limited English (ACS Table C16002); and
C16002_013E	Population of households primarily language Other with limited English (ACS Table C16002).

In addition to calculating the population, the EJ capability calculates the percentage population by dividing the demographic variable by the total population in that block group and converting the fraction to percentage. The naming convention is to use “pct” as a prefix, for example percentage of population below the Census poverty threshold is “pct\_1xpov”.

Coloring of the EJ layer map within AEDT is determined based on the thresholds that have been exceeded. Each blockgroup will be color-coded as follows:

- Yellow: when **pct\_1xpov** has exceeded the threshold.
- Orange: when **pct\_minority** has exceeded the threshold.
- Blue: when **both** pct\_1xpov and pct\_minority have exceeded the threshold.
- Gray: when no attribute has exceeded the threshold.

The coloring of the EJ layer map is driven by the threshold flag column which is created or updated during the EJ analysis. This column can be used in GIS tools such as Esri ArcMap to do further analysis. A summary file with the postfix “\_summary.txt” is created when saving the layer to a shapefile. This will contain the attributes used for analysis and their specified thresholds and associated flags. The threshold flag is a bit field flag. For example, a flag of 3 means that both attributes with flag 1 and 2 have exceeded their threshold.

Of special note, the user should be careful when calculating custom variables based on the demographic variables by race and/or by ethnicity. The U.S. Census allows individuals to select more than one racial group and ethnic group; therefore, the sum of the logical set of demographic variables within one census block will likely exceed the total population within that census block.

### 10.2.2 Limited English Proficiency (LEP)

The LEP capability utilizes ACS data at the spatial resolution of census tracts. Census tracts typically have a population of between 1,200 and 8,000 people with an optimum size of 4,000 people. A census tract usually covers a contiguous area; however, the spatial size of census tracts varies widely depending on the density of settlement. Census tract boundaries are delineated with the intention of being maintained over a long time so that statistical comparisons can be made from census to census.

The following demographic tables from the ACS 5-year estimates are used by the LEP capability. For more information on the ACS demographic variables used by LEP, see

<https://api.census.gov/data/2020/acs/acs5/variables.html>.

Table 10-2 ACS Data Tables Used by Limited English Proficiency

ACS Table	ACS Table ID
LANGUAGE SPOKEN AT HOME FOR THE POPULATION 5 YEARS AND OVER	C16001

#### 10.2.2.1 Demographic Variables used by Limited English Proficiency

The LEP capability tracks a single of demographic variable, which is the ability to ‘Speak English less than “very well”’. These values come directly from the ACS data table without any further post-calculation.

Only certain statistics are calculated for the selected region within AEDT based on the retrieved ACS data. For a full list of all variables that come directly from the ACS data and variables that are calculated, see Section 10.4.

Coloring of the LEP layer map within AEDT is done based upon the selected group of ‘Speak English less than “very well”’ in the LEP Analysis pane and takes the census tract with the highest population within that group, considering that value to be hundred percent value (dark blue) and use that to create ten equal steps as part of the white-to-dark blue gradient. A census tract is greyed out when there is no such population within that census tract for the selected group.

Based on the total population and the LEP population for the selected area, certain statistics are calculated that shows the percent of the population that ‘Speak English less than “very well”’ within that population. Furthermore, for each defined population group within the ‘Speak English less than “very well”’ population, AEDT also calculates the percentage of that population in regard to the total population and the percent of that population based on the whole LEP population.

### 10.3 Environmental Justice Demographic Variables

This section provides details on the demographic variables used by the Environmental Justice capability. Of special note, the user should be careful when calculating custom variables based on the demographic variables by race and/or by ethnicity. The U.S. Census allows individuals to select more than one racial group and ethnic group; therefore, the sum of the logical set of demographic variables within one census block will likely exceed the total population within that census block.

The following tables list variables either taken directly from the ACS data source or calculated from the ACS data.

Table 10-3 Environmental Justice Demographic Variables, from the ACS

Variable	ACS Field Description
FIPS	FIPS Code
STATE	State Name
COUNTY	County Name
NAME	Full Name
B02008_001E	WHITE ALONE OR IN COMBINATION WITH ONE OR MORE OTHER RACES: Total: White alone or in combination with one or more other races -- (Estimate)
B02009_001E	BLACK OR AFRICAN AMERICAN ALONE OR IN COMBINATION WITH ONE OR MORE OTHER RACES: Total: Black or African American alone or in combination with one or more other races -- (Estimate)
B02010_001E	AMERICAN INDIAN AND ALASKA NATIVE ALONE OR IN COMBINATION WITH ONE OR MORE OTHER RACES: Total: People who are American Indian or Alaska Native alone or in combination with one or more other races -- (Estimate)
B02011_001E	ASIAN ALONE OR IN COMBINATION WITH ONE OR MORE OTHER RACES: Total: Asian alone or in combination with one or more other races -- (Estimate)
B02012_001E	NATIVE HAWAIIAN AND OTHER PACIFIC ISLANDER ALONE OR IN COMBINATION WITH ONE OR MORE OTHER RACES: Total: Native Hawaiian and Other Pacific Islander alone or in combination with one or more other races -- (Estimate)
B02013_001E	SOME OTHER RACE ALONE OR IN COMBINATION WITH ONE OR MORE OTHER RACES: Total: Some other race alone or in combination with one or more other races -- (Estimate)
B03002_012E	HISPANIC OR LATINO ORIGIN BY RACE: Total: Hispanic or Latino
B03002_001E	HISPANIC OR LATINO ORIGIN BY RACE: Total: Total population -- (Estimate)
B03002_003E	HISPANIC OR LATINO ORIGIN BY RACE: Not Hispanic or Latino: White alone: Total population -- (Estimate)
C17002_001E	RATIO OF INCOME TO POVERTY LEVEL IN THE PAST 12 MONTHS: Total: Population for whom poverty status is determined -- (Estimate)

Variable	ACS Field Description
C17002_002E	RATIO OF INCOME TO POVERTY LEVEL IN THE PAST 12 MONTHS: Under .50: Population for whom poverty status is determined -- (Estimate)
C17002_003E	RATIO OF INCOME TO POVERTY LEVEL IN THE PAST 12 MONTHS: .50 to .99: Population for whom poverty status is determined -- (Estimate)
C17002_004E	RATIO OF INCOME TO POVERTY LEVEL IN THE PAST 12 MONTHS: 1.00 to 1.24: Population for whom poverty status is determined -- (Estimate)
C16002_001E	HOUSEHOLD LANGUAGE BY HOUSEHOLD LIMITED ENGLISH SPEAKING STATUS: Total: Households -- (Estimate)
C16002_004E	HOUSEHOLD LANGUAGE BY HOUSEHOLD LIMITED ENGLISH SPEAKING STATUS: Spanish: Limited English speaking household: Households -- (Estimate)
C16002_007E	HOUSEHOLD LANGUAGE BY HOUSEHOLD LIMITED ENGLISH SPEAKING STATUS: Other Indo-European languages: Limited English speaking household: Households -- (Estimate)
C16002_010E	HOUSEHOLD LANGUAGE BY HOUSEHOLD LIMITED ENGLISH SPEAKING STATUS: Asian and Pacific Island languages: Limited English speaking household: Households -- (Estimate)
C16002_013E	HOUSEHOLD LANGUAGE BY HOUSEHOLD LIMITED ENGLISH SPEAKING STATUS: Other languages: Limited English speaking household: Households -- (Estimate)
B01001_001E	SEX BY AGE: Total: Total population -- (Estimate)
B19013_001E	MEDIAN HOUSEHOLD INCOME IN THE PAST 12 MONTHS (IN 2020 INFLATION-ADJUSTED DOLLARS): Median household income in the past 12 months (in 2020 inflation-adjusted dollars): Households -- (Estimate)
state_id	State FIPS Code
county_id	County FIPS Code
Tract	Census Tract Code
block group	Block Group Code

Table 10-4 Environmental Justice Demographic Variables, Derived from ACS

Variable	Description / Calculation
pop_total	Copy of field B01001_001E
pop_white	Copy of field B02008_001E
pop_afam	Copy of field B02009_001E
pop_amind	Copy of field B02010_001E
pop_asian	Copy of field B02011_001E
pop_hawaii	Copy of field B02012_001E
pop_other	Copy of field B02013_001E
pop_hispanic	Copy of field B03002_012E



Variable	Description / Calculation
med_hh_income	Copy of field B19013_001E
pop_minority	Total population of block group minus the non-Hispanic White only population.  B03002_001E - B03002_003E
pct_minority	Percent of total population that is minority.  round(pop_minority / B03002_001E * 100, 1)
pop_1xpov	C17002_002E + C17002_003E
pct_1xpov	round(pop_1xpov / C17002_001E * 100, 1)
pop_lang	C16002_004E + C16002_007E + C16002_010E + C16002_013E
pct_lang	round(pop_lang / C16002_001E * 100, 1)
thresholdflag	Possible values are 0, 1, 2, 3. 0 – no threshold exceeded 1 – yellow, pct_1xpov exceeds threshold 2 – orange, pct_minority exceeds threshold 3 – both pct_1xpov and pct_minority exceed threshold

### 10.4 Limited English Proficiency Demographic Variables

This section provides details on the demographic variables used by the LEP capability. The following is a list of variables that are taken directly from the ACS data source.

Table 10-5 ACS 2020 Limited English Proficiency Demographic Variables

Variable	ACS Field Description
C16001_001E	Total population
C16001_005E	Spanish: Speak English less than "very well"
C16001_008E	French, Haitian, or Cajun: Speak English less than "very well"
C16001_011E	German or other West Germanic languages: Speak English less than "very well"
C16001_014E	Russian, Polish, or other Slavic languages: Speak English less than "very well"
C16001_017E	Other Indo-European languages: Speak English less than "very well"
C16001_020E	Korean: Speak English less than "very well"
C16001_023E	Chinese (incl. Mandarin, Cantonese): Speak English less than "very well"
C16001_026E	Vietnamese: Speak English less than "very well"
C16001_029E	Tagalog (incl. Filipino): Speak English less than "very well"
C16001_032E	Other Asian and Pacific Island languages: Speak English less than "very well"
C16001_035E	Arabic: Speak English less than "very well"
C16001_038E	Other and unspecified languages: Speak English less than "very well"

### 10.4.1 Backwards Compatibility for ACS 2015 Data

AEDT supports 2020 American Community Survey (ACS) 5-year data for the Environmental Justice analysis and 2020 ACS 5-year data for the Limited English Proficiency analysis by default. 2015 ACS 5-year data is also supported for Limited English Proficiency analyses which includes more language categories than the 2020 dataset.

The following is a list of language categories made available when the *Enable 2015 ACS Census Language Categories* option is selected in the *Study* tab, *Preferences*, *Environmental Justice Model* screen. When this option is selected, the 2015 Tract feature layer is used with the 2015 ACS data.

Table 10-6 ACS 2015 Limited English Proficiency Demographic Variables

2015 ACS Field Description
Spanish or Spanish Creole: Speak English less than "very well"
French (incl. Patois, Cajun): Speak English less than "very well"
French Creole: Speak English less than "very well"
Italian: Speak English less than "very well"
Portuguese or Portuguese Creole: Speak English less than "very well"
German: Speak English less than "very well"
Yiddish: Speak English less than "very well"
Scandinavian languages: Speak English less than "very well"
Greek: Speak English less than "very well"
Russian: Speak English less than "very well"
Polish: Speak English less than "very well"
Serbo-Croatian: Speak English less than "very well"
Other Slavic languages: Speak English less than "very well"
Armenian: Speak English less than "very well"
Persian: Speak English less than "very well"
Gujarati: Speak English less than "very well"
Hindi: Speak English less than "very well"
Urdu: Speak English less than "very well"
Other Indic languages: Speak English less than "very well"
Other Indo-European languages: Speak English less than "very well"
Chinese: Speak English less than "very well"
Japanese: Speak English less than "very well"
Korean: Speak English less than "very well"
Mon-Khmer, Cambodian: Speak English less than "very well"
Hmong: Speak English less than "very well"
Thai: Speak English less than "very well"

---

<b>2015 ACS Field Description</b>
Laotian: Speak English less than "very well"
Vietnamese: Speak English less than "very well"
Other Asian languages: Speak English less than "very well"
Tagalog: Speak English less than "very well"
Other Pacific Island languages: Speak English less than "very well"
Navajo: Speak English less than "very well"
Other Native North American languages: Speak English less than "very well"
Hungarian: Speak English less than "very well"
Arabic: Speak English less than "very well"
Hebrew: Speak English less than "very well"
African languages: Speak English less than "very well"
Other and unspecified languages: Speak English less than "very well"

## 11. Appendix – Noise

### 11.1 Noise Adjustment and Metric Derivations

This appendix provides detailed derivations for the following noise adjustments and metrics: the acoustic impedance adjustment (Section 11.1.1), the noise exposure fraction adjustment (Section 11.1.2), and the equation to compute the time-above metric (Section 11.1.3).

#### 11.1.1 Derivation of the Acoustic Impedance Adjustment

The majority of noise level data in the AEDT Fleet database were derived from data originally measured during aircraft noise certification tests conducted in accordance with the Code of Federal Regulation, Title 14, Aeronautics and Space, Part 36, "Noise Standards: Aircraft Type and Airworthiness Certification" (14 CFR Part 36)<sup>26</sup>. Section B36.7 of 14 CFR Part 36 states that the noise measurements must be corrected to the following (homogeneous) noise certification reference atmospheric conditions:

1. Sea level pressure of 2116 psf (76 cm mercury);
2. Ambient temperature of 77°F (25° C);
3. Relative humidity of 70%; and
4. Zero wind.

The concept of acoustic impedance (denoted by the symbol  $\rho c$ ) is used in AEDT to correct the reference-day NPD data to the off-reference, non-sea level conditions associated with the user-specified case airport. Acoustic impedance is the product of the density of air and the speed of sound, and is a function of temperature, atmospheric pressure, and indirectly MSL altitude. An acoustic impedance of 409.81 newton-seconds/m<sup>3</sup> corresponds to the reference atmospheric conditions as defined by 14 CFR Part 36. Acoustic impedance adjustments are correct for the differences between reference-day sea-level conditions to airport-specific temperature and altitude.

Harris<sup>57</sup> and Beranek<sup>58</sup> both contain empirical curves showing acoustic impedance adjustment as a function of temperature and atmospheric pressure (see Figure 11-1 and Figure 11-2). These curves can be used to obtain a general sense for the magnitude and direction of the adjustment. However they are not appropriate for correcting AEDT noise-power-distance (NPD) data because the curves are referenced to an acoustic impedance of 406 and 400 newton-seconds/m<sup>3</sup>, respectively, not the 409.81 newton-seconds/m<sup>3</sup> associated with NPD reference-day conditions in AEDT.

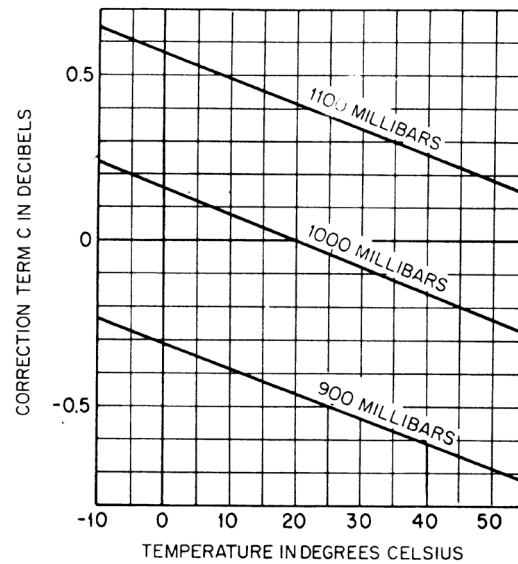

Figure 11-1 Acoustic Impedance Adjustment re. 406 newton-second/m<sup>3</sup>

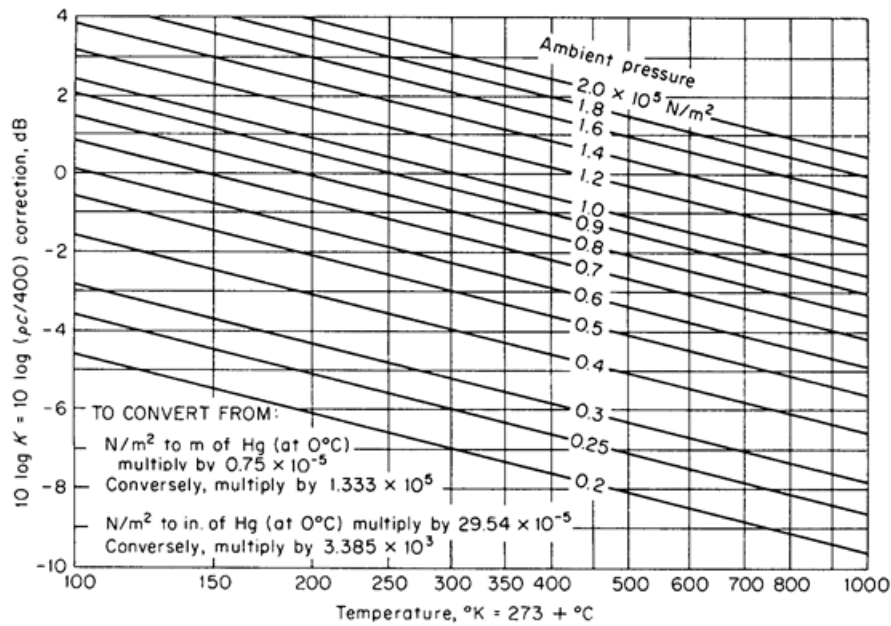

Figure 11-2 Acoustic Impedance Adjustment re. 400 newton-second/m<sup>3</sup>

The acoustic impedance adjustment is relatively small, usually less than a few tenths of a decibel. However, when there is a significant variation in temperature and atmospheric pressure relative to reference-day conditions, the adjustment can be substantial. For example, Denver International Airport is at an elevation of approximately 5,000 feet, and assuming a temperature of 70°F and an atmospheric pressure of 29.92 in-Hg, an acoustic impedance adjustment of -0.77 dB is added to NPD noise curves.

The acoustic impedance adjustment is computed by:

$$AI_{ADJ} = 10 \cdot \log_{10} \left[ \frac{\rho c}{409.81} \right] \quad \text{Eq. 11-1}$$

where

- $AI_{ADJ}$  Acoustic impedance adjustment to be added to noise level data in the AEDT NPD database (dB); and  
 $\rho c$  Acoustic impedance at observer MSL altitude and pressure (newton-seconds/m<sup>3</sup>).

$$\rho \cdot c = 416.86 \cdot \left[ \frac{\delta}{\theta^{1/2}} \right] \quad \text{Eq. 11-2}$$

where

- $\delta$  Ratio of atmospheric pressure at observer altitude to standard-day pressure at sea level.

$$\delta = \left[ \left( \frac{P}{29.92} \right)^{\frac{1}{5.256}} - \left( \frac{3.566 \times 10^{-3} A}{518.67} \right) \right]^{5.256} \quad \text{Eq. 11-3}$$

where

- $\theta$  Ratio of absolute temperature at observer altitude to standard-day temperature at sea level.

$$\theta = \frac{[459.67 + T - (3.566 \times 10^{-3}) \cdot (A - E)]}{518.67} \quad \text{Eq. 11-4}$$

where

- A Observer elevation MSL (feet);  
 E Airport elevation MSL (feet);  
 T Temperature at airport (°F); and  
 P Atmospheric pressure at airport relative to MSL (in-Hg).

Harris<sup>57</sup> and Beranek<sup>58</sup> explain the acoustic impedance adjustment in terms of sound intensity and sound pressure. In a free field for plane waves or spherical waves, the sound pressure and particle velocity are in phase, and the magnitude of the intensity (power per unit area) in the direction of propagation of the sound waves is related to the mean-square sound pressure by:

$$I = \frac{p^2}{\rho c} \quad \text{Eq. 11-5}$$

where

- I Sound intensity (power per unit area);  
 $p^2$  Mean-square sound pressure; and  
 $\rho c$  Acoustic impedance.

Two sound intensities at a given distance from a given acoustical power source, one measured under actual conditions and the other measured under reference-day conditions are equivalent as shown:

$$\frac{p^2}{\rho c} = \frac{p_{ref}^2}{\rho c_{ref}} \quad \text{Eq. 11-6}$$

where

$$\frac{p^2}{\rho c} \quad \text{Sound intensity, actual conditions; and}$$

$$\frac{p_{ref}^2}{\rho c_{ref}} \quad \text{Sound intensity, reference-day conditions.}$$

By rearranging terms and dividing by a constant  $p_0 = 20 \mu\text{Pa}$ , the equation becomes:

$$\frac{p^2}{p_0^2} = \left( \frac{p_{ref}^2}{p_0^2} \right) \left( \frac{\rho c}{\rho c_{ref}} \right) \quad \text{Eq. 11-7}$$

Converting to decibels,

$$10 \cdot \log_{10} \left[ \frac{p^2}{p_0^2} \right] = 10 \cdot \log_{10} \left[ \frac{p_{ref}^2}{p_0^2} \right] + 10 \cdot \log_{10} \left[ \frac{\rho c}{\rho c_{ref}} \right] \quad \text{Eq. 11-8}$$

and substituting symbols, produces the noise level adjustment equation (in dB):

$$L = L_{ref} + 10 \cdot \log_{10} \left[ \frac{\rho c}{\rho c_{ref}} \right] \quad \text{Eq. 11-9}$$

where

$$L \quad \text{Corrected NPD level at an airport;}$$

$$L_{ref} \quad \text{NPD level in the AEDT database for reference-day conditions; and}$$

$$10 \cdot \log_{10} \left[ \frac{\rho c}{\rho c_{ref}} \right] \quad \text{Acoustic impedance adjustment, } AI_{ADJ}, \text{ as seen in Eq. 11-1.}$$

### 11.1.2 Derivation of the Noise Exposure Fraction Adjustment<sup>59,60</sup>

This section presents a derivation of the noise exposure fraction equation used in AEDT. The assumptions are that the aircraft is on a straight and level flight path flying at constant speed. The equations are based upon a fourth-power, 90 degree dipole model of sound radiation. The geometry for the derivation is shown in the figure below.

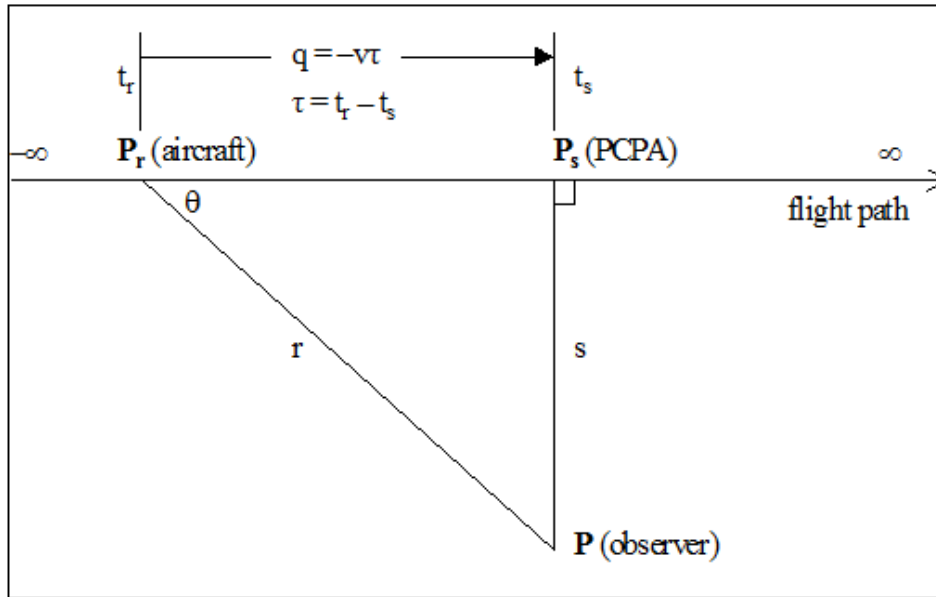

Figure 11-3 Observer/Flight Path Geometry

- r distance from the observer at point **P** to the aircraft at point **Pr** (ft);
- s perpendicular distance from the observer at point **P** to PCPA at point **Ps** (ft);
- q distance along the flight path relative to PCPA (ft);
- v speed of the aircraft (ft/s);
- tr time at which the aircraft is located at point **Pr** (s);
- ts time at which the aircraft is located at point **Ps** (s);
- τ time difference, tr minus ts (s);
- θ angle formed by the flight path and a connecting segment from the aircraft at point **Pr** to the observer at point **P**;
- pr root-mean-square sound pressure generated by the aircraft at point **Pr**; and
- ps root-mean-square sound pressure generated by the aircraft at point **Ps**.

The relative distance, q, along the flight path from point **Pr** to point **Ps** is computed from the scalar product of two vectors: **PrP**, from the aircraft to the observer; and the unit vector, **u**, in the direction of the flight path.

$$q = \mathbf{P_r P} \cdot \mathbf{u} = \frac{\mathbf{P_r P} \cdot \mathbf{P_r P_s}}{|\mathbf{P_r P_s}|} \tag{Eq. 11-10}$$

The value of q is positive if the aircraft is located behind the perpendicular closest point of approach to an extended line segment, PCPA, (as pictured in Figure 11-3), and the value of q is negative if the aircraft is ahead of PCPA. In terms of speed and time,

$$q = -v \cdot \tau \tag{Eq. 11-11}$$

The sign in Eq. 11-11 is negative because τ is negative when the aircraft is behind PCPA.



The noise fraction algorithm is derived from a fourth-power, 90 degree dipole time history model. In this model,  $p_r^2$  is the mean-square sound pressure at the observer due to the aircraft, located at point  $P_r$ ; and  $p_s^2$  is the mean-square sound pressure at the observer when the aircraft is located at PCPA at point  $P_s$ . The mean-square pressure,  $p_r^2$ , at the observer is expressed in terms  $p_s^2$  by:

$$p_r^2 = p_s^2 \cdot \left( \frac{s^2}{r^2} \right) \cdot \sin^2(\theta) \quad \text{Eq. 11-12}$$

which becomes:

$$p_r^2 = p_s^2 \cdot \frac{s^4}{r^4} \quad \text{Eq. 11-13}$$

In this equation, the mean-square sound pressure for an aircraft flying along a straight path is determined by  $r^2$  spherical spreading loss and by a  $\sin^2\theta$  "90 degree dipole" term that accounts for a variety of physical phenomena. These phenomena include atmospheric absorption, which is accentuated in front of the airplane due to Doppler shift, sound refraction away from the hot gases behind the airplane, and ground attenuation. The purpose of the dipole term is to shape the sides of the time-history curve to fit empirical data<sup>23</sup>. When the  $\sin\theta$  term is replaced by  $s/r$ , the mean-square sound pressure is seen to vary inversely as  $r^4$ ; therefore, another name for the model is the fourth-power time-history model.

The Pythagorean theorem can be used to solve for  $r^2$

$$r^2 = s^2 + q^2 \quad \text{Eq. 11-14}$$

Which can be rewritten as follows, based on Eq. 11-11:

$$r^2 = s^2 + (v\tau)^2 \quad \text{Eq. 11-15}$$

$$\left( \frac{r}{s} \right)^2 = 1 + \left( \frac{v \cdot \tau}{s} \right)^2 \quad \text{Eq. 11-16}$$

Equation 10-16 can then be substituted into Eq. 11-13, in order to derive the mean-square pressure as a function of time:

$$p_r^2(\tau) = \frac{p_s^2}{\left( 1 + \left( \frac{v \cdot \tau}{s} \right)^2 \right)^2} \quad \text{Eq. 11-17}$$

The integral of the mean-square pressure, from time  $\tau_1$  to  $\tau_2$ , is the segment noise exposure  $E_{12}$

$$E_{12} = \int_{\tau_1}^{\tau_2} p_r^2(\tau) d\tau \quad \text{Eq. 11-18}$$

By using the substitution:

$$\alpha = \frac{v \cdot \tau}{s} \quad \text{Eq. 11-19}$$

the segment noise exposure integral becomes:

$$E_{12} = p_s^2 \cdot \left(\frac{s}{v}\right) \cdot \int_{\alpha_1}^{\alpha_2} \frac{1}{(1 + \alpha^2)^2} d\alpha \quad \text{Eq. 11-20}$$

and its solution is:

$$E_{12} = p_s^2 \cdot \left(\frac{s}{v}\right) \cdot \left(\frac{1}{2}\right) \cdot \left\{ \left[ \frac{\alpha_2}{(1 + \alpha_2^2)} + \tan^{-1}(\alpha_2) \right] - \left[ \frac{\alpha_1}{(1 + \alpha_1^2)} + \tan^{-1}(\alpha_1) \right] \right\} \quad \text{Eq. 11-21}$$

The total noise exposure from  $\tau_1 = -\infty$  to  $\tau_2 = \infty$  is:

$$E_\infty = \frac{1}{2} \cdot \pi \cdot p_s^2 \cdot \frac{s}{v} \quad \text{Eq. 11-22}$$

The noise exposure fraction,  $F_{12}$ , is the noise exposure between time  $\tau_1$  and  $\tau_2$  divided by the total noise exposure:

$$F_{12} = \frac{E_{12}}{E_\infty} \quad \text{Eq. 11-23}$$

$$F_{12} = \left(\frac{1}{\pi}\right) \cdot \left[ \frac{\alpha_2}{(1 + \alpha_2^2)} + \tan^{-1}(\alpha_2) - \frac{\alpha_1}{(1 + \alpha_1^2)} - \tan^{-1}(\alpha_1) \right] \quad \text{Eq. 11-24}$$

The next part of the derivation shows how to calculate  $\alpha_1$  and  $\alpha_2$ .

The AEDT NPD database contains noise exposure level data referenced to 160 kt,  $L_{E,160}$ , and maximum noise level data,  $L_{Smx}$ . These noise level data are related to the parameters in the above equations by:

$$L_{E,160} = 10 \cdot \log_{10} \left[ \left(\frac{v}{v_0}\right) \cdot \frac{E_\infty}{(p_0^2 \cdot t_0)} \right] \quad \text{Eq. 11-25}$$

$$L_{Smx} = 10 \cdot \log_{10} \left[ \frac{P_s^2}{P_0^2} \right] \quad \text{Eq. 11-26}$$

where

$p_0$       20  $\mu$ Pa;

$t_0$	1 sec for $L_{AE}$ and $L_{CE}$ , or 10 sec for $L_{EPN}$ ; and
$v_0$	270.05 ft/s (160 ks).

To ensure that the total exposure obtained from the fourth-power time-history model in Eq. 11-22 is consistent with AEDT NPD data, the following relationship must hold:

$$L_{E,160} - L_{Smx} = 10 \cdot \log_{10} \left[ \left( \frac{v}{v_0} \right) \cdot \frac{\left( \frac{1}{2} \cdot \pi \cdot p_s^2 \cdot \frac{s}{v} \right)}{(p_0^2 \cdot t_0)} \right] - 10 \cdot \log_{10} \left[ \frac{p_s^2}{p_0^2} \right] \quad \text{Eq. 11-27}$$

therefore

$$\frac{1}{2} \cdot \pi \cdot \frac{s}{(v_0 \cdot t_0)} = 10^{\frac{[L_{E,160} - L_{Smx}]}{10}} \quad \text{Eq. 11-28}$$

and the distance,  $s$ , is scaled to fit the NPD data:

$$s = \left( \frac{2}{\pi} \right) \cdot v_0 \cdot t_0 \cdot 10^{\frac{[L_{E,160} - L_{Smx}]}{10}} \quad \text{Eq. 11-29}$$

Using the symbol  $s_L$  to indicate a scaled distance, rather than the actual distance, the NPD-consistency requirement becomes:

$$s_L = s_0 \cdot 10^{\frac{[L_{E,160} - L_{Smx}]}{10}} \quad \text{Eq. 11-30}$$

where

$s_0$	A constant dependent on the type of noise exposure level;
$s_0$	171.92 feet (52.4 meters) for $L_{AE}$ and $L_{CE}$ ; and
$s_0$	1719.2 feet (524.0 meters) for $L_{EPN}$ .

Using the scaled distance,  $s_L$ , Eq. 11-11, and Eq. 11-19, the two  $\alpha$ -numbers that are needed to calculate the noise exposure fraction,  $F_{12}$ , are determined by  $q = q_1$  at the start of a segment:

$$\alpha_1 = \frac{-q_1}{s_L} \quad \text{Eq. 11-31}$$

$$\alpha_2 = \frac{(-q_1 + L)}{s_L} \quad \text{Eq. 11-32}$$

where

$q_1$	Relative distance (ft) from segment start point to point $P_s$ and
$L$	Length of segment (ft).

### 11.1.3 Derivation of the Time-Above Equation

The equation to compute the time-above metric in AEDT can be developed by using the previously developed time-history equation and substituting  $s = s_L$ , the mean-square pressure is written as a function of time difference ( $\tau$ ) and speed ( $v$ ), using Eq. 11-17:

$$p_r^2 = \frac{p_s^2}{\left(1 + \left(\frac{v \cdot \tau}{s_L}\right)^2\right)^2} \quad \text{Eq. 11-33}$$

The time-history equation is solved for  $\tau$  as a function of  $p_r$ :

$$\tau = \left(\frac{s_L}{v}\right) \cdot \left[\left(\frac{p_s}{p_r}\right)^2 - 1\right]^{1/2} \quad \text{Eq. 11-34}$$

Given a noise threshold level,  $L_x$ , of root-mean-square pressure,  $p_x$ :

$$L_x = 10 \cdot \log_{10} \left[ \frac{p_x^2}{p_0^2} \right] \quad \text{Eq. 11-35}$$

The time duration (in seconds) during which the noise level exceeds  $L_x$ ,  $\Delta t_x$ , is twice the  $\tau$ -value at  $p_r = p_x$ :

$$\Delta t_x = 2 \cdot \left(\frac{s_L}{v}\right) \cdot \left[\left(\frac{p_s}{p_x}\right)^2 - 1\right]^{1/2} \quad \text{Eq. 11-36}$$

which can be written as:

$$\Delta t_x = \begin{cases} 2 \cdot \left(\frac{s_L}{v}\right) \cdot \left[10^{\frac{[L_{Smx,adj} - L_x]}{20}} - 1\right]^{1/2} & L_x < L_{Smx,adj} \\ 0.0 & L_x \geq L_{Smx,adj} \end{cases} \quad \text{Eq. 11-37}$$

where

$L_{Smx,adj}$  The adjusted maximum noise level at the observer.

Note that:

$$\frac{s_L}{v} = \left(\frac{2}{\pi}\right) \cdot \left(\frac{t_0 \cdot v_0}{v}\right) \cdot 10^{\frac{[L_{E,160,adj} - L_{Smx,adj}]}{10}} \quad \text{Eq. 11-38}$$

and that:

$$L_{E,adj} = L_{E,160,adj} + 10 \cdot \log_{10} \left[ \frac{v_0}{v} \right] \quad \text{Eq. 11-39}$$

where

- $L_{E,160,adj}$  Adjusted noise exposure level referenced to 160 knots;
- $L_{E,adj}$  Adjusted noise exposure level at the observer; and
- $L_{Smx,adj}$  Adjusted maximum noise level at the observer.

Eq. 11-36 can be written to express time-above duration (in minutes) in terms of adjusted exposure and maximum levels:

$$\Delta t_x = \left( \frac{1}{60} \right) \cdot \left( \frac{4}{\pi} \right) \cdot t_0 \cdot \left[ 10^{\frac{[L_{E,adj} - L_{Smx,adj}]}{10}} \right] \cdot \left[ 10^{\frac{[L_{Smx,adj} - L_x]}{20}} - 1 \right]^{\frac{1}{2}} \quad \text{Eq. 11-40}$$

#### 11.1.4 Recalculation of NPD Data for Non-Reference Conditions

The noise level contributions from each segment of the flight path are derived from the NPD data stored in the international ANP database. However, it is important to note that these data have been normalized using average atmospheric attenuation rates defined in SAE-AIR-1845<sup>3</sup> based on analysis done during the ICAO Committee on Aircraft Noise 7th meeting cycle<sup>61</sup>. Those rates are averages of values determined during aeroplane noise certification testing in Europe and the United States. The wide variation of atmospheric conditions (temperature and relative humidity) in those tests is shown in Figure 11-1.

An atmospheric absorption adjustment accounts for changes in noise levels due to the atmospheric absorption for study or airport-specific atmospheric conditions that differ from the reference atmospheric conditions. The curves overlaid on Figure 11-1, calculated using an industry standard atmospheric attenuation model SAE-ARP-866A<sup>2</sup>, illustrate that across the test conditions a substantial variation of high frequency (8 kHz) sound absorption would be expected (although the variation of overall absorption would be less). Since SAE-ARP-5534<sup>4</sup> is currently being evaluated as a possible replacement for SAE-ARP-866A<sup>2</sup> for aircraft noise certification, AEDT provides the flexibility to model non-standard atmospheric conditions with either SAE-ARP-5534<sup>4</sup> or SAE-ARP-866A<sup>2</sup>. Both methods are presented in this section.

Because the attenuation rates, given in Table 11-1, are arithmetic averages, the complete set cannot be associated with a single reference atmosphere (i.e., with specific values of temperature and relative humidity). They should be thought of as properties of a purely notional atmosphere – referred to as the “reference atmosphere”.

Table 11-1 Average Atmospheric Attenuation Rates from SAE-AIR-1845<sup>3</sup>

Center Frequency of 1/3-octave band [Hz]	Attenuation Rate [dB/100m]	Center Frequency of 1/3-octave band [Hz]	Attenuation Rate [dB/100m]
50	0.033	800	0.459
63	0.033	1,000	0.590
80	0.033	1,250	0.754
100	0.066	1,600	0.983
125	0.066	2,000	1.311
160	0.098	2,500	1.705
200	0.131	3,150	2.295
250	0.131	4,000	3.115
315	0.197	5,000	3.607
400	0.230	63,00	5.246
500	0.295	8,000	7.213
630	0.361	10,000	9.836

ACTUAL DAY CONDITIONS RECORDED  
DURING CERTIFICATION TESTING

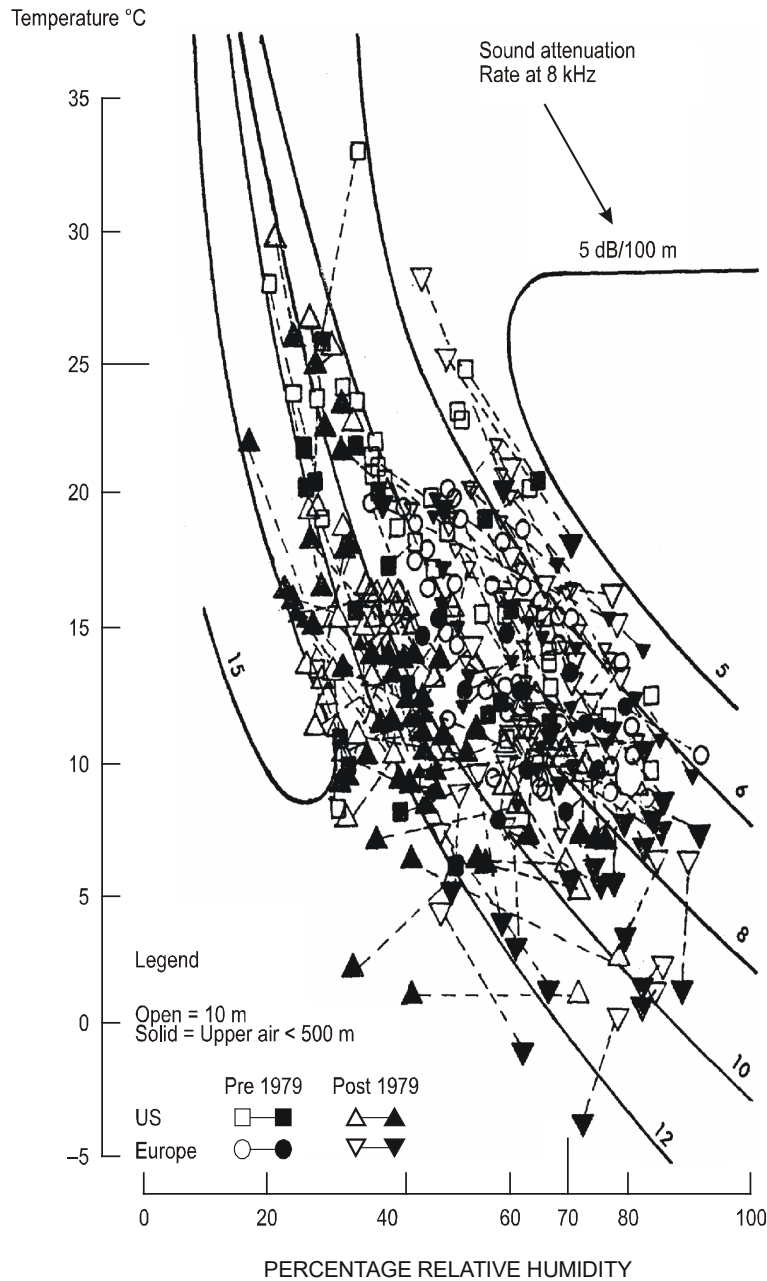

Figure 11-4 Meteorological Conditions Recorded During Noise Certification Tests<sup>61</sup>

The attenuation coefficients in Table 11-1 should be considered valid over reasonable ranges of temperature and humidity. However, to check whether adjustments may be necessary, SAE-ARP-5534<sup>4</sup> or SAE-ARP-866A<sup>2</sup> should be used to calculate the atmospheric absorption for the specific airport temperature  $T$ , relative humidity  $RH$  and atmospheric pressure  $p$ . If a comparison of these attenuation

rates with those in Table 11-1 indicates that adjustment is required, the following methodology should be used.

The ANP database provides the following NPD data for each power setting (all data being normalized to the reference atmosphere):

- maximum sound level versus slant distance,  $L_{max}(d)$ ;
- time integrated level versus distance for the reference airspeed,  $L_E(d)$ ; and
- unweighted reference sound spectrum at a slant distance of 305 m (1,000 ft),  $L_{n,ref}(d_{ref})$  where  $n$  = frequency band (ranging from 1 to 24 for 1/3-octave bands with Center frequencies from 50 Hz to 10 kHz).

Adjustment of the NPD curves to user-specified conditions  $T$  and  $RH$  is performed in three steps:

The reference spectrum is corrected to remove the reference atmospheric attenuation  $\alpha_{n,ref}$ :

$$L_n(d_{ref}) = L_{n,ref}(d_{ref}) + \alpha_{n,ref} \cdot d_{ref} \quad \text{Eq. 11-41}$$

where

$L_n(d_{ref})$  The unattenuated spectrum at  $d_{ref} = 305$  m (1,000 ft); and

$\alpha_{n,ref}$  The coefficient of atmospheric absorption for the frequency band  $n$  taken from Table 11-1 (but expressed in dB/m).

The corrected spectrum is adjusted to each of the ten standard NPD distances<sup>x1</sup>  $d_i$  using attenuation rates for both the reference atmosphere and the specified atmosphere (based on either SAE-ARP-5534<sup>4</sup> or SAE-ARP-866A<sup>2</sup>).

For the reference atmosphere:

$$L_{n,ref}(d_i) = L_n(d_{ref}) - 20 \cdot \log\left(\frac{d_i}{d_{ref}}\right) - \alpha_{n,ref} \cdot d_i \quad \text{Eq. 11-42}$$

For the specified atmosphere:

$$L_{n,atm}(T, p_a, h_{rel}, d_i) = L_n(d_{ref}) - 20 \cdot \log\left(\frac{d_i}{d_{ref}}\right) - \delta_n(T, p_a, h_{rel}) \cdot d_i \quad \text{Eq. 11-43}$$

where

$\delta_n(T, p_a, h_{rel})$  The coefficient of atmospheric absorption for the frequency band  $n$  (expressed in dB/m) calculated using either SAE-ARP-5534<sup>4</sup> or SAE-ARP-866A<sup>2</sup> with temperature  $T$ , atmospheric pressure  $p_a$  and relative humidity  $h_{rel}$ .

At each NPD distance  $d_i$  the two spectra are A-weighted and decibel-summed to determine the resulting A-weighted levels  $L_{A,atm}$  and  $L_{A,ref}$ , which are then subtracted arithmetically:

<sup>x1</sup> The NPD distances are 200; 400; 630; 1,000; 2,000; 4,000; 6,300; 10,000; 16,000; and 25,000 ft.



$$\begin{aligned}
 \Delta_L(T, p_a, h_{rel}, d_i) &= L_{A,ATM}(T, p_a, h_{rel}, d_i) - L_{A,ref}(d_i) \\
 &= 10 \cdot \log \left( \sum_{n=17}^{40} 10^{(L_{n,atm}(T, p_a, h_{rel}, d_i) - A_n)/10} \right) \\
 &\quad - 10 \cdot \log \left( \sum_{n=17}^{40} 10^{(L_{n,ref}(d_i) - A_n)/10} \right)
 \end{aligned}
 \tag{Eq. 11-44}$$

The increment  $\Delta_L(T, p_a, h_{rel}, d_i)$  is the difference between the NPD in the specified atmosphere and the reference atmosphere at the NPD distance  $d_i$ . This is added to the ANP database NPD data value to derive the adjusted NPD data.

Applying  $\Delta_L(T, p_a, h_{rel}, d_i)$  to adjust both  $L_{max}$  and  $L_E$  NPDs effectively assumes that different atmospheric conditions affect the reference spectrum only and have no effect on the shape of the level-time-history. This may be considered valid for typical propagation ranges and typical atmospheric conditions. The following is an example of the application of the NPD spectral adjustment: adjust standard NPD data to the atmosphere 10°C, 80% relative humidity and sea level atmospheric pressure.

Using the SEL NPD data presented in the AEDT Fleet database for the V2527A, the matching spectral classes in the ANP database are 103 and 205 for departure and arrival, respectively. The spectra data are tabulated in Table 11-2.

First the spectrum levels (referenced to 305 m (1,000 ft)) are corrected back to the source to remove the reference atmosphere, ignoring spherical spreading effects. This is done using Eq. 11-41. The corresponding spectra at source are also tabulated in Table 11-2.

Table 11-2 Spectra for V2527 NPD from ANP Database and Calculated Source Spectra

Frequency (Hz)	At 1,000 ft		At source	
	DEP_103 (dB)	ARR_205 (dB)	DEP_103 (dB)	ARR_205 (dB)
50	56.7	68.3	56.8	68.4
63	66.1	60.7	66.2	60.8
80	70.1	64.6	70.2	64.7
100	72.8	67.4	73.0	67.6
125	76.6	78.4	76.8	78.6
160	73.0	74.8	73.3	75.1
200	74.5	71.4	74.9	71.8
250	77.0	72.4	77.4	72.8
315	75.3	72.0	75.9	72.6
400	72.2	72.4	72.9	73.1
500	72.2	71.6	73.1	72.5
630	71.2	72.0	72.3	73.1
800	70.2	71.0	71.6	72.4
1,000	70.0	70.0	71.8	71.8
1,250	69.6	68.9	71.9	71.2
1,600	71.1	67.2	74.1	70.2
2,000	70.6	65.8	74.6	69.8
2,500	67.1	64.4	72.3	69.6
3,150	63.4	63.0	70.4	70.0
4,000	63.5	62.0	73.0	71.5
5,000	58.2	60.6	69.2	71.6
6,300	51.5	54.4	67.5	70.4
8,000	42.3	48.5	64.3	70.5
10,000	37.7	39.0	67.7	69.0

The source spectra data are then propagated out to the standard NPD data distances using Eq. 11-42 and Eq. 11-43, together with the absorption coefficients in Table 11-1 for the reference atmosphere and using absorption coefficients calculated using SAE ARP-866A<sup>2</sup> and SAE ARP-5534<sup>4</sup> for the atmosphere, 10°C, 80% relative humidity, 101.325 kPa (sea level). All three sets of absorption coefficients are listed in Table 11-3.

Table 11-3 Reference Absorption Coefficients (from Table 11-1) and Coefficients for 10°C/80% Relative Humidity/101.325 kPa Calculated using SAE-ARP-866A<sup>2</sup> and SAE-ARP-5534<sup>4</sup>

Frequency (Hz)	Reference absorption (dB/100 m)	ARP-866A <sup>2</sup> 10°C/80% relative humidity (dB/100 m)	ARP-5534 <sup>4</sup> 10°C/80% relative humidity /101.325 kPa (dB/100 m)
50	0.033	0.021	0.007
63	0.033	0.027	0.011
80	0.033	0.034	0.017
100	0.066	0.043	0.026
125	0.066	0.053	0.039
160	0.098	0.068	0.056
200	0.131	0.086	0.078
250	0.131	0.107	0.104
315	0.197	0.135	0.134
400	0.230	0.172	0.166
500	0.295	0.216	0.201
630	0.361	0.273	0.241
800	0.459	0.349	0.292
1,000	0.590	0.439	0.364
1,250	0.754	0.552	0.471
1,600	0.983	0.738	0.636
2,000	1.311	0.985	0.893
2,500	1.705	1.322	1.297
3,150	2.295	1.853	1.931
4,000	3.115	2.682	2.922
5,000	3.607	3.216	4.461
6,300	5.246	4.580	6.826
8,000	7.213	6.722	10.398
10,000	9.836	9.774	15.661

At each NPD distance, the 1/3-octave band levels are A-weighted and decibel-summed to give the overall A-weighted level at each distance. This is repeated for both the departure spectrum (103) and the approach spectrum (205). For each NPD distance, the A-weighted levels are then subtracted to give the increment,  $\Delta L$ . The A-weighted levels and increments  $\Delta_{AA}$  are shown in Table 11-5 for SAE-ARP-866A<sup>2</sup> and Table 11-6, Table 11-7, and Table 11-8 for SAE-ARP-5534<sup>4</sup>.

Table 11-4 A-weighted Levels for Reference and SAE-ARP-866A Atmosphere and Difference Between Each Atmosphere,  $\Delta_L$

Distance (ft)	DEP_103			ARR_205		
	$L_{A,ref}$ (dBA)	$L_{A,866A}$ (dBA)	$\Delta_L$ (dB)	$L_{A,ref}$ (dBA)	$L_{A,866A}$ (dBA)	$\Delta_L$ (dB)
200	97.0	97.2	0.2	95.8	95.9	0.1
400	90.3	90.6	0.3	88.9	89.2	0.3
630	85.6	86.0	0.4	84.2	84.6	0.4
1,000	80.6	81.2	0.6	79.2	79.8	0.5
2,000	72.5	73.4	0.9	71.3	72.2	0.8
4,000	63.6	64.9	1.3	62.7	63.9	1.2
6,300	57.4	59.0	1.5	56.4	58.0	1.6
10,000	50.7	52.5	1.8	49.5	51.4	2.0
16,000	43.3	45.5	2.2	41.8	44.1	2.3
25,000	35.3	38.2	2.8	34.0	36.7	2.7

Table 11-5 A-weighted Levels for Reference and SAE-ARP-5534<sup>4</sup> Atmosphere and Difference Between Each Atmosphere,  $\Delta_L$

Distance (ft)	DEP_103			ARR_205		
	$L_{A,ref}$ (dBA)	$L_{A,5534}$ (dBA)	$\Delta_L$ (dB)	$L_{A,ref}$ (dBA)	$L_{A,5534}$ (dBA)	$\Delta_L$ (dB)
200	97.0	97.1	0.1	95.8	95.8	0.0
400	90.3	90.6	0.3	88.9	89.1	0.2
630	85.6	86.1	0.4	84.2	84.6	0.3
1,000	80.6	81.3	0.7	79.2	79.8	0.6
2,000	72.5	73.7	1.2	71.3	72.4	1.1
4,000	63.6	65.4	1.8	62.7	64.4	1.7
6,300	57.4	59.6	2.1	56.4	58.6	2.2
10,000	50.7	53.2	2.4	49.5	52.2	2.7
16,000	43.3	46.2	2.9	41.8	45.0	3.2
25,000	35.3	38.9	3.6	34.0	37.7	3.7

The departure and approach increments shown in Table 11-4 and Table 11-5 are then added to the departure and approach ANP database NPD thrust levels (Table 11-6) to construct the new NPD with SAE-ARP-866A<sup>2</sup> shown in Table 11-7 atmospheric absorption and new NPD with SAE-ARP-5534<sup>4</sup> atmospheric absorption shown in Table 11-8.

Table 11-6 Original NPD Data

NPD Identifier	Noise Descriptor	Op Mode	Power Setting	L_200ft	L_400ft	L_630ft	L_1,000ft	L_2,000ft	L_4,000ft	L_6,300ft	L_10,000ft	L_16,000ft	L_25,000ft
V2527A	SEL	A	2,000	93.1	89.1	86.1	82.9	77.7	71.7	67.1	61.9	55.8	49.2
V2527A	SEL	A	2,700	93.3	89.2	86.2	83.0	77.7	71.8	67.2	62.0	55.8	49.3
V2527A	SEL	A	6,000	94.7	90.5	87.4	83.9	78.5	72.3	67.7	62.5	56.3	49.7
V2527A	SEL	D	10,000	95.4	90.7	87.3	83.5	77.7	71.1	66.3	60.9	54.6	47.4
V2527A	SEL	D	14,000	100.4	96.1	93.0	89.4	83.5	77.0	72.2	66.7	60.1	53.0
V2527A	SEL	D	18,000	103.2	99.1	96.2	92.9	87.4	81.1	76.5	71.1	64.9	57.9
V2527A	SEL	D	22,500	105.1	101.2	98.5	95.4	90.3	84.3	79.9	74.8	68.7	62.0

Table 11-7 Revised NPD Data Using SAE-ARP-866A<sup>2</sup>

NPD Identifier	Noise Descriptor	Op Mode	Power Setting	L_200ft	L_400ft	L_630ft	L_1,000ft	L_2,000ft	L_4,000ft	L_6,300ft	L_10,000ft	L_16,000ft	L_25,000ft
V2527A	SEL	A	2,000	93.2	89.4	86.5	83.4	78.5	72.9	68.7	63.9	58.1	51.9
V2527A	SEL	A	2,700	93.4	89.5	86.6	83.5	78.5	73.0	68.8	64.0	58.1	52.0
V2527A	SEL	A	6,000	94.8	90.8	87.8	84.4	79.3	73.5	69.3	64.5	58.6	52.4
V2527A	SEL	D	10,000	95.6	91.0	87.7	84.1	78.6	72.4	67.8	62.7	56.8	50.2
V2527A	SEL	D	14,000	100.6	96.4	93.4	90.0	84.4	78.3	73.7	68.5	62.3	55.8
V2527A	SEL	D	18,000	103.4	99.4	96.6	93.5	88.3	82.4	78.0	72.9	67.1	60.7
V2527A	SEL	D	22,500	105.3	101.5	98.9	96.0	91.2	85.6	81.4	76.6	70.9	64.8

Table 11-8 Revised NPD Data Using SAE-ARP-5534<sup>4</sup>

NPD Identifier	Noise Descriptor	Op Mode	Power Setting	L_200ft	L_400ft	L_630ft	L_1,000ft	L_2,000ft	L_4,000ft	L_6,300ft	L_10,000ft	L_16,000ft	L_25,000ft
V2527A	SEL	A	2,000	93.1	89.3	86.4	83.5	78.8	73.4	69.3	64.6	59.0	52.9
V2527A	SEL	A	2,700	93.3	89.4	86.5	83.6	78.8	73.5	69.4	64.7	59.0	53.0
V2527A	SEL	A	6,000	94.7	90.7	87.7	84.5	79.6	74.0	69.9	65.2	59.5	53.4
V2527A	SEL	D	10,000	95.5	91.0	87.7	84.2	78.9	72.9	68.4	63.3	57.5	51.0
V2527A	SEL	D	14,000	100.5	96.4	93.4	90.1	84.7	78.8	74.3	69.1	63.0	56.6
V2527A	SEL	D	18,000	103.3	99.4	96.6	93.6	88.6	82.9	78.6	73.5	67.8	61.5
V2527A	SEL	D	22,500	105.2	101.5	98.9	96.1	91.5	86.1	82.0	77.2	71.6	65.6

### 11.1.5 Calculating Audibility

This appendix provides a description of the computation of the Time Audible (TAUD) metric in AEDT.

Audibility is defined as the ability for an attentive listener to hear aircraft noise. Detectability is based on signal detection theory<sup>62,63</sup>, and depends on both the actual aircraft sound level (“signal”) and the ambient sound level (or “noise”). As such, audibility is based on many factors including the listening environment in which one is located. Conversely, detectability is a theoretical formulation based on a significant body of research. For the purposes of AEDT modeling the terms “audibility” and “detectability” are used interchangeably. The detectability level ( $d'$ ) calculated in AEDT is based on the signal-to-noise ratio within one-third octave band spectra for both the signal and noise, using a  $10\log(d')$  value of 7 dB.

There are three parts to the calculation of audibility in AEDT:

1. Calculate the detectability level ( $D'L_{\text{band}}$ ) for each one-third octave band of the signal for a single contributing flight path segment;
2. Calculate the detectability level ( $D'L_{\text{total}}$ ) for the overall signal for a single contributing flight path segment; and
3. Calculate absolute or percentage of time a signal is audible (detectable by a human) for a flight path (TAUD or TAUDP).

#### Definitions

$L_{\text{signal,band}}$	sound level of the signal (aircraft) for a particular frequency band
$L_{\text{noise,band}}$	sound level of the ambient noise for a particular frequency band
$\eta_{\text{band}}$	efficiency of the detector (a scalar value known for each frequency band)
Bandwidth	one-third octave bandwidth
$D'L_{\text{band}}$	detectability level for a particular frequency band
$D'L_{\text{total}}$	total detectability level
$d'_{\text{band}}$	detectability for a particular frequency band
$d'_{\text{total}}$	sum of squares of detectability over all frequency bands
TAUD	absolute amount of time a signal is audible by humans
TAUDP	percentage of a time period that a signal is audible

Note that values of  $L_{\text{signal,band}}$  and  $L_{\text{noise,band}}$  are calculated for each segment-receiver pair and then the total audibility for a given flight track is summed from the individual segments.

#### Part I of Calculations

Calculate the detectability level for each one-third octave frequency band, and then determine if the signal for that frequency band is detectable.

The theory of detectability level is based on the following equation:

$$D'L_{band} = 10 \cdot \log_{10} \left[ \eta_{band} \cdot (bandwidth)^{\frac{1}{2}} \cdot \left( \frac{signal}{noise} \right) \right] \quad \text{Eq. 11-45}$$

The following one-third octave band filter characteristics are used in the calculation of detectability:

Table 11-9 One-Third Octave Band Characteristics

ANSI Band #	Nominal Center Frequency (Hz)	Bandwidth (Hz)	$10 \log[\eta_{band}]$
17	50	11	-6.96
18	63	15	-6.26
19	80	19	-5.56
20	100	22	-5.06
21	125	28	-4.66
22	160	40	-4.36
23	200	44	-4.16
24	250	56	-3.96
25	315	75	-3.76
26	400	95	-3.56
27	500	110	-3.56
28	630	150	-3.56
29	800	190	-3.56
30	1000	220	-3.56
31	1250	280	-3.76
32	1600	400	-3.96
33	2000	440	-4.16
34	2500	560	-4.36
35	3150	750	-4.56
36	4000	950	-4.96
37	5000	1100	-5.36
38	6300	1500	-5.76
39	8000	1900	-6.26
40	10000	2200	-6.86

- 1) Calculate the detectability level for each one-third octave frequency band.

$$D'L_{band} = (L_{signal,band} - L_{noise,band}) + \{10 \cdot \log_{10}[\eta_{band}] + 0.5 \cdot 10 \cdot \log_{10}[bandwidth]\} \quad \text{Eq. 11-46}$$

where

$10 \log[\eta_{band}]$  one-third octave band specific constant (see Table 11-9), and  
 $L_{noiseband}$  the addition of the un-weighted, measured one-third octave band ambient levels and the appropriate EASN level (see Table 11-10).

Figure 11-5 and Table 11-10 below present the Equivalent Auditory System Noise (EASN)<sup>64</sup> levels derived for modeling audibility using one-third octave band data.

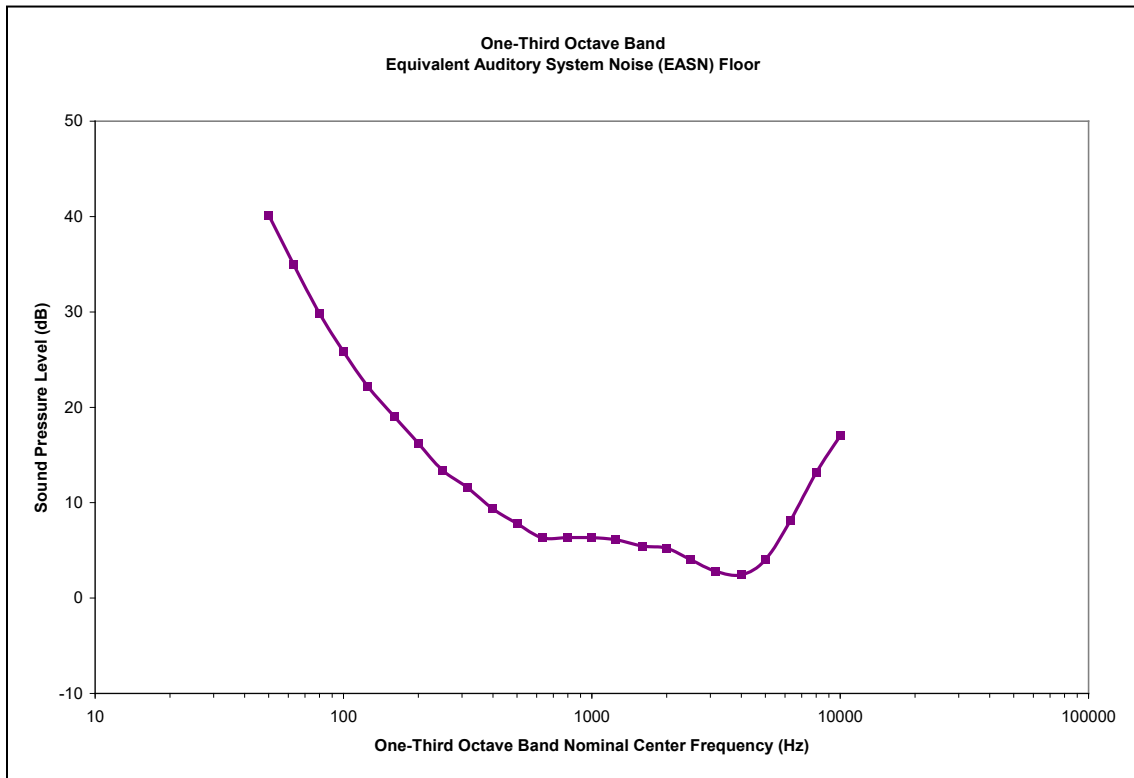

Figure 11-5 EASN Threshold



Table 11-10 EASN Threshold

One-Third Octave Band Nominal Center Frequency (Hz)	EASN Threshold (dB)
50	40.2
63	35.0
80	29.8
100	25.8
125	22.2
160	19.0
200	16.2
250	13.4
315	11.6
400	9.3
500	7.8
630	6.3
800	6.3
1000	6.3
1250	6.1
1600	5.4
2000	5.2
2500	4.0
3150	2.8
4000	2.4
5000	4.0
6300	8.1
8000	13.1
10000	17.0

- 2) Determine if the signal for that frequency band is detectable.

If  $D'L_{band} \geq 7$ , the signal is flagged as **detectable** for that frequency band.

## Part II of Calculations

Determine if the overall signal is detectable.

- 1) Calculate the detectability for each one-third octave frequency band using the band detectability levels from Part I.

$$d'_{band} = 10^{\frac{D'L_{band}}{10}} \quad \text{Eq. 11-47}$$

- 2) Calculate the square root of the sum of squares of detectability over all frequency bands.

$$d'_{total} = \left[ \sum_{band=17}^{40} (d'_{band})^2 \right]^{1/2} \quad \text{Eq. 11-48}$$

- 3) Calculate the total detectability level.

$$D'L_{total} = 10 \cdot \log_{10} [d'_{total}] \quad \text{Eq. 11-49}$$

- 4) Determine if the overall signal is detectable.

$$\begin{array}{ll} D'L_{total} \geq 7 & \text{the overall signal is detectable.} \\ D'L_{total} < 7 & \text{the overall signal is not detectable.} \end{array} \quad \text{Eq. 11-50}$$

### Part III of Calculations

Calculate the absolute or percentage of time a signal is audible by a human; the time for a single contributing flight path segment is first calculated, then the absolute or percent time is calculated for an overall event or larger period of time (multiple flights for an average day or other time period).

- 1) Calculate the time audible (in seconds) for a single flight path.

For each segment, calculate time it takes aircraft to travel through flight path segment

$$segtime = \left( \frac{seglength}{segspeed} \right) \cdot \# \text{ of operations} \quad \text{Eq. 11-51}$$

where

seglength      length (in feet) of contributing flight path segment,  
 segspeed      average speed (in feet/s) during contributing flight path segment, and  
 segtime      time passed during contributing flight path segment(s).

If segment is flagged as detectable, then

$$TAud = TAud + segtime \quad \text{Eq. 11-52}$$

Once *segtime* has been totaled for all segments, the percent Time Audible over the user-specified time period will be:

$$\%TAud = \frac{TAud}{(T)} \quad \text{Eq. 11-53}$$

where

T the user-specified time period(s).

- 2) Calculate the time audible (in minutes) for a time period.

$$TAud = \frac{TAud}{\left(\frac{60 \text{ seconds}}{\text{minute}}\right)} \quad \text{Eq. 11-54}$$

## 11.2 Acoustic Data Development

This appendix provides detailed descriptions of the acoustic data development process for AEDT: the acoustic data development criteria (Section 11.2.1), and an overview of spectral class development (Section 11.2.2).

### 11.2.1 Acoustic Data Development Criteria

Guidance for developing acoustic aircraft source data is presented in detail in Appendix B of SAE-AIR-1845 “Procedure for the Computation of Airplane Noise in the Vicinity of Airports”<sup>3</sup>. While this guidance is specific for developing SEL NPDs for fixed-wing aircraft, it may be modified in order to develop NPDs for other base noise metrics (LAMAX, EPNL and PNLTM) and aircraft types (helicopters and military aircraft).

Supplemental criteria for developing fixed-wing aircraft and helicopter NPDs are presented below.

For fixed-wing aircraft, criteria for development of NPD data for use by AEDT include the following<sup>18</sup>:

- Acoustically soft ground under the measurement microphone, similar to the terrain around the microphone during aircraft noise certification tests<sup>26,65</sup>.
- For  $L_{AE}$  and  $L_{EPN}$  values, an integrated adjustment procedure (involving time integration over the full spectral time history) as compared with a simplified adjustment procedure (involving the spectrum measured at the time of maximum noise level only) for airplanes where adequate field data are available.
- Reference-day air attenuation coefficients as specified by SAE-ARP-866A<sup>2</sup>.
- $L_{AE}$  and  $L_{EPN}$  values time-integrated over the upper 10 dB of the noise event as prescribed by the 14 CFR Part 36<sup>26</sup> and SAE-AIR-1845<sup>3</sup>. (The time interval from  $t_1$  to  $t_2$  designates the time in seconds, from the beginning to the end of the integration period for the sound produced by an airplane. The duration  $[t_2 - t_1]$  should be long enough to include all significant contributions to the total noise exposure. Sufficient accuracy is usually achieved by integration over the time interval during which the frequency-weighted sound level is within ten dB of its maximum value.)
- $L_{AE}$  and  $L_{EPN}$  values normalized to reference aircraft speed of 160 knots for both approach and departure NPDs.

- Noise levels specified as a function of power, in the form of corrected net thrust per engine<sup>xli</sup>.

In addition, criteria for development of helicopter NPD data for use by AEDT also include the following:

- $L_{AE}$  and  $L_{EPN}$  values normalized to helicopter- and operation-specific reference speeds.
- Noise levels specified as a function of helicopter mode at the three microphone locations for dynamic modes. A single microphone location may be utilized for static modes. Noise levels may also be specified as a function of angle around the helicopter for static modes, in order to establish helicopter directivity during this configuration (see Section 4.5.3).

For the complete AEDT Database Submittal Forms, please contact [aedt-support@dot.gov](mailto:aedt-support@dot.gov).

The FAA position is to adhere closely to the above criteria both for the development and validation of the AEDT NPD data. Diligent compliance is needed to ensure confidence in having consistent and comparable aircraft NPD and performance data. More information on the AEDT data validation is presented in Section 11.2.3.

It is important to note that the civil fixed wing aircraft noise and performance data that make up the AEDT database are also included in ICAO's Aircraft Noise and Performance (ANP) database. The ANP database is maintained by EUROCONTROL, and may be accessed via the internet at: <http://www.aircraftnoisemodel.org>.

### 11.2.2 Overview of Spectral Class Development

For each aircraft acoustic data submittal to the AEDT Fleet database, a spectral class assignment is made by either pairing the aircraft with an appropriate existing spectral class, or developing a new spectral class for the aircraft. The original development and assignment of spectral classes was performed in 1999<sup>66</sup>. Additional spectral classes are developed as needed, if there are no reasonable representations of that aircraft's spectral acoustic data in the current database.

This section provides an example of the derivation of a spectral class for the AEDT database. Departure spectral class #104 is used in this example. The class originally consisted of the Fokker F28-2000, the McDonnell-Douglas MD80 series aircraft (i.e., MD81, MD82 and MD83), and the Gulfstream G11B and G11C twin-engine turbofan aircraft.

The B737700 and the hushkit retrofitted B737N17 and B737N19 have NPD curves referenced to spectral class 104. They were added to the AEDT database after the original derivations were performed and were found to agree with an already developed class based on the criteria described in Step 1 through Step 4 below<sup>67</sup>. A more detailed description of the spectral class assignment process is described in Section 11.3.2.

---

<sup>xli</sup> For FAA AEDT-mandated analysis, FAA AEE approval is required in order to develop NPDs for fixed-wing aircraft with any power parameter other than net corrected thrust.

**Step 1: Group Similar Aircraft/Engine Combinations**

The first step in deriving a spectral class is the grouping of aircraft considered similar based on the combination of the aircraft and engine types. Considerations for grouping aircraft include the airframe, type of engine, number of engines, location of engine, and bypass ratio.

**Step 2: Visual Inspection of Potential Spectral Class Data**

After having grouped the aircraft by similar aircraft/engine types, the maximum-level spectra are compared. Specifically, each spectrum at the time of A-weighted Maximum Sound Level ( $L_{AS_{mx}}$ ) is graphed on a single chart and visually inspected for similarity. Similarity is based on the shape of the spectrum and the relative location of any tones below 1,000 Hz. The spectra for class 104 are presented in Figure 11-6.

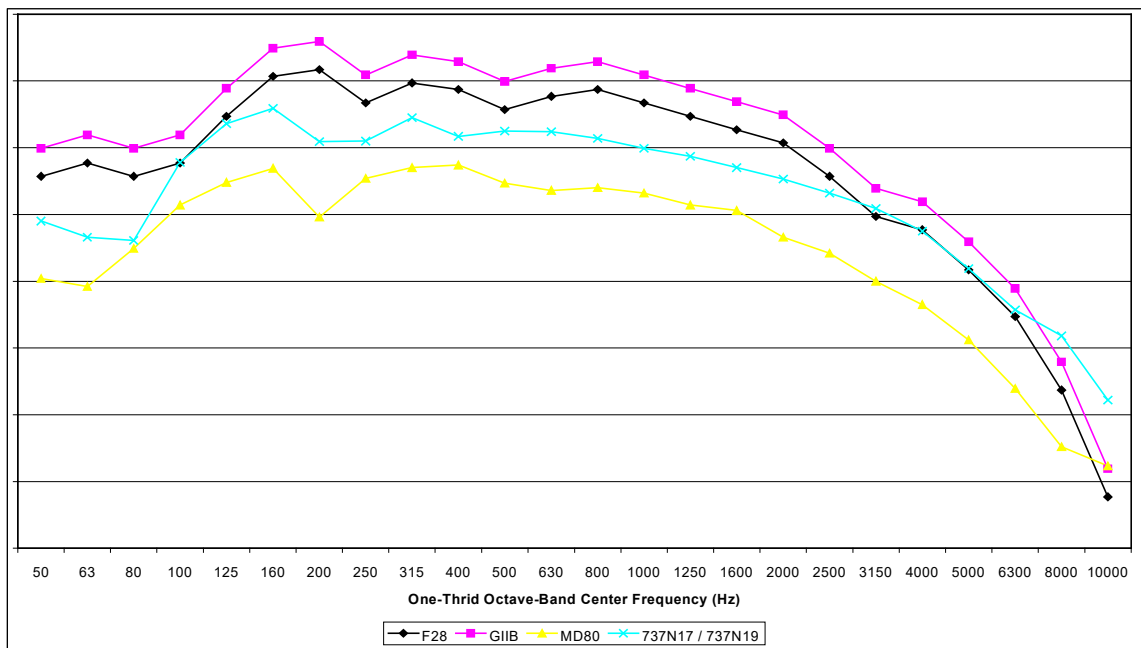

Figure 11-6 Departure Class 104

To aid in the visual inspection of the spectra, each one is normalized to a value of 70 dB at 1,000 Hz. Figure 11-7 presents the normalized spectra along with the *proposed* spectrum that would represent this spectral class. The representative spectrum for this spectral class is the weighted arithmetic average of the individual one-third octave-band spectral data. The weighting was based on a recent annual survey<sup>68,69</sup> of the number of departures for each aircraft type<sup>xlii</sup>.

<sup>xlii</sup> The representative spectrum for commercial aircraft was determined considering operational information contained in the 1995 national operational data base [ref x]; and the representative spectrum for military aircraft was determined considering 1997 fleet inventory data [ref y].

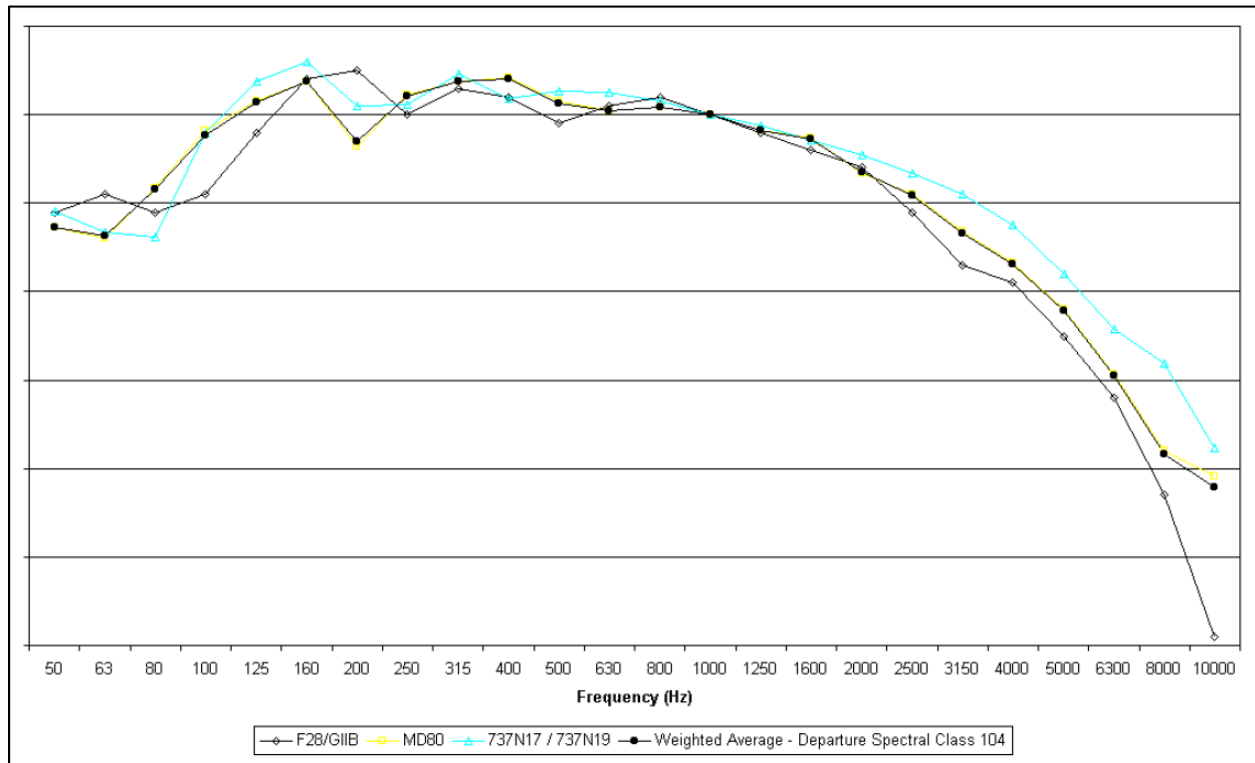

Figure 11-7 Normalized Spectral Class 104 Data

### Step 3: Verification of Proposed Spectral Class

In order to verify the appropriateness of the proposed spectral class, the individual spectra and the representative were systematically evaluated using the acoustical calculations that require third-octave band spectra data: atmospheric absorption effects (Section 4.3.1), and barrier (or line of sight blockage, Section 4.3.6) effects. Testing parameters were chosen to represent the range of plausible airport conditions (temperature, humidity, slant distance, and path-length difference due to line-of-sight terrain blockage).

#### Step 3.A: Atmospheric Absorption Effects

The assessment of spectral classes in the calculation of atmospheric absorption adjustment ( $AA_{adj}$ ) effects was conducted using a range of atmospheric conditions which are representative of realistic airport conditions. Monthly atmospheric data for the 34 Operational Evolution Plan (OEP) airports was originally obtained from the National Oceanic and Atmospheric Administration (NOAA) website by accessing the “Local Climatological Data Annual Summary” report. Reported were the 30-year average (1971-2004) monthly temperature, and a 1-year (2004) average monthly minimum and maximum relative humidity at each airport weather station. Thus, the database for this analysis contained 816 representative temperature/humidity conditions (34 airports, 12 months, 2 temperature/humidity combinations per month); 670 of these values were unique, 146 were duplicates. Table 11-11 contains the descriptive statistics of this database. Notably, the average condition at these airports closely resembles the International Standard Atmosphere, Standard Day condition of 59 °F and 70% relative humidity. Figure 11-8 graphically depicts the conditions represented in this database.

Table 11-11 OEP Airport Atmospheric Condition Statistics

	Mean	Median	Minimum	Maximum
Temperature	59 °F	61 °F	51 °F	93 °F
Relative Humidity	67%	67%	12%	93%

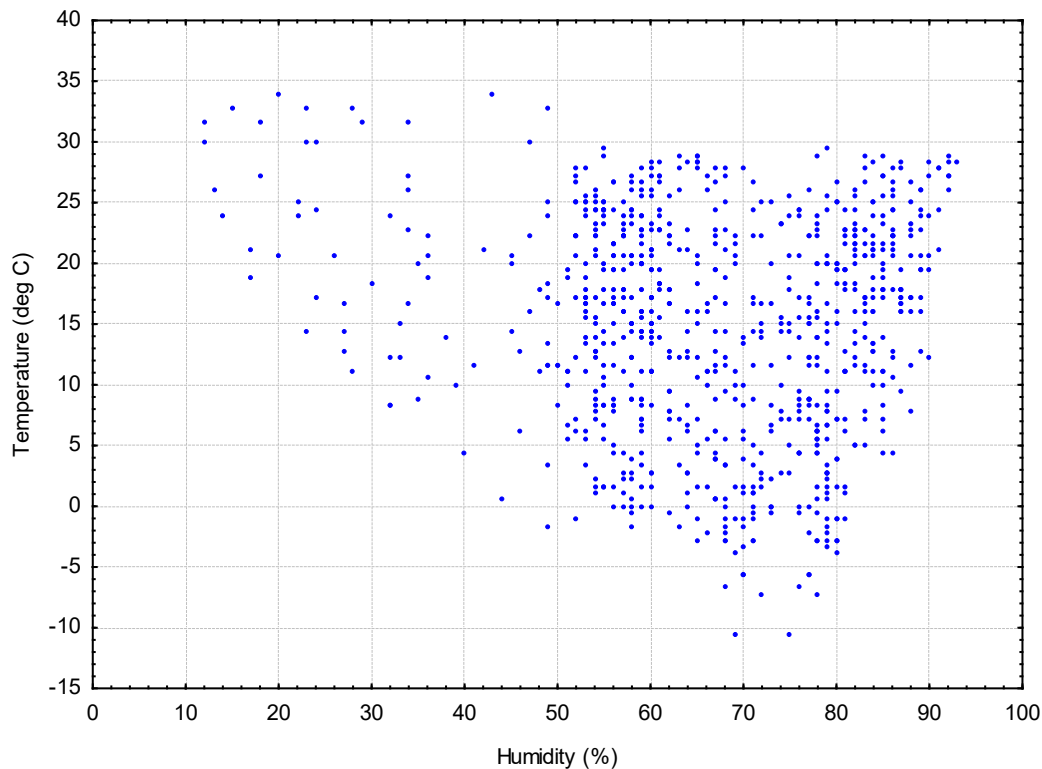

Figure 11-8 Range of Average Airport Atmospheric Conditions Represented in the AEDT Database

The  $AA_{adj}$  was calculated for each aircraft using discrete points from a uniform distribution of slant distance and the 816 values collected from the temperature and humidity condition distribution, using SAE-ARP-866A<sup>2</sup>. These discrete slant distance points correspond to the 10 standard AEDT distances (200, 400, 630, 1,000, 2,000, 4,000, 6,300, 10,000, 16,000, and 25,000 ft). The uncertainties associated with the use of spectral classes in the calculation of AEDT's atmospheric absorption adjustment ( $\Delta AA_{adj}$ ) were computed by subtracting the  $AA_{adj}$  calculated using each individual aircraft from the  $AA_{adj}$  calculated using the representative spectrum from the associated spectral class. In this manner, a positive value indicates that the use of spectral classes results in an over-prediction of the resulting noise level. The resulting database of approximately 1.2 million  $\Delta AA_{adj}$  uncertainty values is depicted in Figure 11-9. Table 11-12 presents further summary of these values grouped by aircraft power setting, aircraft type, atmospheric conditions, and slant distance. It tabulates the distribution of these values within  $\pm 1$  and  $\pm 2$  dB bounds. In general, the vast majority of these values are within  $\pm 1$  dB. Slightly larger errors occur for the following: 1) approach conditions, where SPLs in the high-frequency bands are prevalent in the source spectrum; 2) propeller-driven aircraft, where tonal components are present in the spectrum; and 3) low humidity conditions, where atmospheric absorption is most significant.

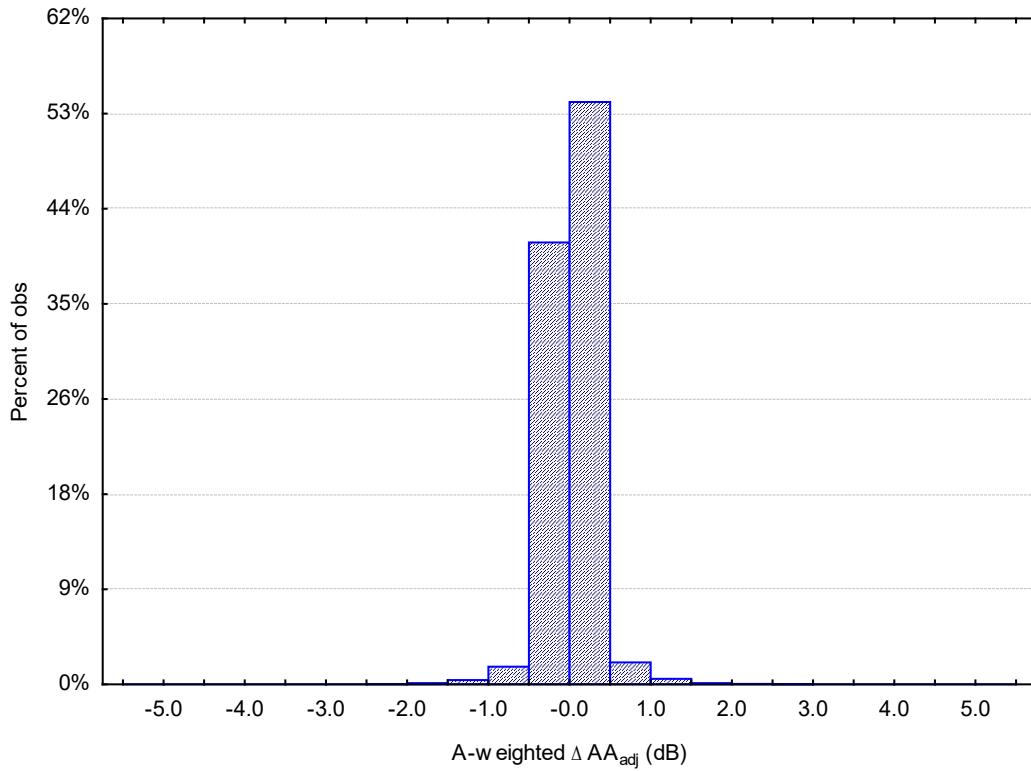

Figure 11-9 Histogram of A-weighted  $\Delta AA_{adj}$



Table 11-12 Summary of A-weighted  $\Delta A_{adj}$ 

Data Subset	% of Data Within $\pm 1$ dB	% of Data Within $\pm 2$ dB
All	98.7	99.9
Departure Power	99.4	100.0
Approach Power	98.1	99.8
Jet Aircraft	99.0	99.9
Prop Aircraft	98.0	100.0
Departure Power, Jet Aircraft	100.0	100.0
Approach Power, Jet Aircraft	98.0	99.7
Departure Power, Prop Aircraft	98.0	100.0
Approach Power, Prop Aircraft	98.4	100.0
Temp $\leq$ 39°F, Humidity $\leq$ 55%	97.7	99.5
Temp $\geq$ 80.6°F, Humidity $\leq$ 55%	99.1	99.8
Temp $\leq$ 39°F, Humidity $\geq$ 80%	98.1	99.3
Temp $\geq$ 80.6°F, Humidity $\geq$ 80%	98.7	99.9
200 ft Slant Distance	98.7	99.8
400 ft Slant Distance	97.4	99.6
630 ft Slant Distance	98.0	99.7
1,000 ft Slant Distance	99.2	100.0
2,000 ft Slant Distance	99.8	100.0
4,000 ft Slant Distance	99.6	99.9
6,300 ft Slant Distance	99.8	100.0
10,000 ft Slant Distance	99.9	100.0
16,000 ft Slant Distance	99.1	100.0
25,000 ft Slant Distance	96.0	100.0

### Step 3.B: Line-of-Sight Blockage Effects

The second assessment was conducted to determine the uncertainty associated with the use of spectral classes for the calculation of the  $LOS_{adj}$ , which accounts for the attenuation due to line-of-sight blockage from terrain features. The  $LOS_{adj}$  uncertainty values ( $\Delta LOS_{adj}$ ) due to the use of spectral classes were computed by subtracting the  $LOS_{adj}$  calculated using each individual aircraft spectrum from the  $LOS_{adj}$  calculated using the representative spectrum from the associated spectral class. In this manner, a positive  $\Delta LOS_{adj}$  represents an over-prediction of the resulting noise level.

$\Delta LOS_{adj}$  was calculated for 14 path-length differences (-1, 0.1, 0.5, 1, 2, 4, 6, 8, 10, 12, 14, 16, 18, and 20 ft)<sup>xliii</sup> at the 816 average monthly OEP temperature and humidity conditions and the 10 standard AEDT slant distances. The resulting database of approximately 17 million  $\Delta LOS_{adj}$  values, or differences, associated with the use of spectral classes is depicted in Figure 11-10.

<sup>xliii</sup> The value of  $\delta_0 = -1$  ft is a value used for testing only that represents a grazing incidence case where the direct line-of-sight is not obstructed, and in turn will result in the computation of a negative Fresnel number. It is not meant to represent a realistic path length difference.

Table 11-13 summarizes the  $\Delta\text{LOS}_{\text{adj}}$  with breakdowns by aircraft power setting, aircraft type, atmospheric conditions, slant distance, and path-length difference. The A-weighted  $\Delta\text{LOS}_{\text{adj}}$  values are almost all within a  $\pm 2.5$  dB range, and the large majority of values (over 90%) are within a  $\pm 1$  dB range. Slightly larger errors occur for the following: 1) propeller-driven aircraft, where tonal components can dominate the spectrum; 2) shorter slant distances; and 3) path-length differences between 1 and 6 ft (near grazing incidence), where barrier attenuation is most frequency dependent.

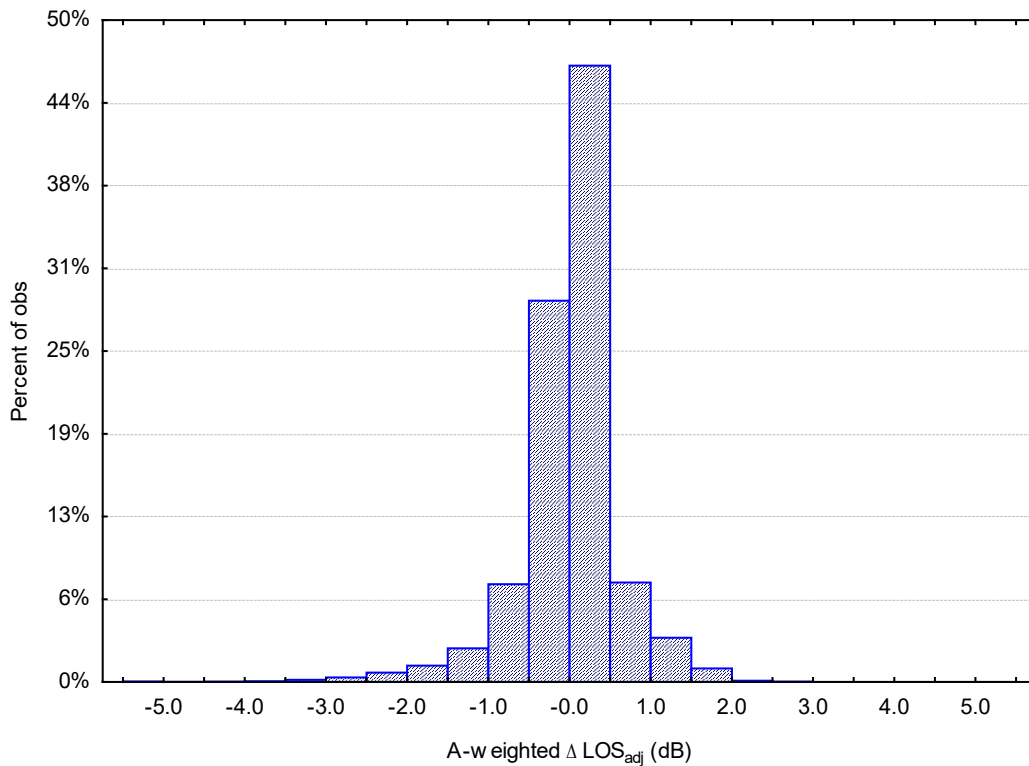

Figure 11-10 Histogram of A-Weighted  $\Delta\text{LOS}_{\text{adj}}$

Table 11-13 Summary of A-Weighted  $\Delta\text{LOS}_{\text{adj}}$ 

Data Subset	% of Data Within $\pm 1$ dB	% of Data Within $\pm 2$ dB
All	90.4	98.6
Departure Power	90.3	99.0
Approach Power	90.4	98.1
Jet Aircraft	93.8	99.4
Prop Aircraft	80.5	96.1
Departure Power, Jet Aircraft	92.8	99.7
Approach Power, Jet Aircraft	94.8	99.2
Departure Power, Prop Aircraft	83.0	97.0
Approach Power, Prop Aircraft	83.0	97.0
Temp $\leq$ 39°F, Humidity $\leq$ 55%	91.6	98.9
Temp $\geq$ 80.6°F, Humidity $\leq$ 55%	90.9	98.7
Temp $\leq$ 39°F, Humidity $\geq$ 80%	90.7	98.7
Temp $\geq$ 80.6°F, Humidity $\geq$ 80%	90.4	98.5
200 ft Slant Distance	87.4	96.5
400 ft Slant Distance	88.2	97.3
630 ft Slant Distance	88.8	97.8
1,000 ft Slant Distance	89.1	98.3
2,000 ft Slant Distance	89.0	98.8
4,000 ft Slant Distance	89.2	98.8
6,300 ft Slant Distance	89.9	99.0
10,000 ft Slant Distance	91.7	99.4
16,000 ft Slant Distance	94.2	99.7
25,000 ft Slant Distance	96.5	100.0
$\delta_0 = -1$ ft	100.0	100.0
$\delta_0 = 0.1$ ft	96.6	99.0
$\delta_0 = 0.5$ ft	87.4	97.6
$\delta_0 = 1$ ft	83.0	96.9
$\delta_0 = 2$ ft	80.9	96.6
$\delta_0 = 4$ ft	82.2	97.2
$\delta_0 = 6$ ft	83.9	98.0
$\delta_0 = 8$ ft	87.5	98.6
$\delta_0 = 10$ ft	89.2	98.6
$\delta_0 = 12$ ft	91.8	98.7
$\delta_0 = 14$ ft	94.3	98.9
$\delta_0 = 16$ ft	95.4	99.7
$\delta_0 = 18$ ft	96.1	100.0
$\delta_0 = 20$ ft	96.9	100.0

**Step 4: Final Spectral Class**

Given that the curves for each individual aircraft spectrum adjusted by the aforementioned spectral-based effects fall within the  $\pm 1$ -dB limit curves for all elevation angles, the proposed representative spectrum is considered to adequately represent the individual spectra used to derive the spectral class. Figure 11-11 presents the final spectral class.

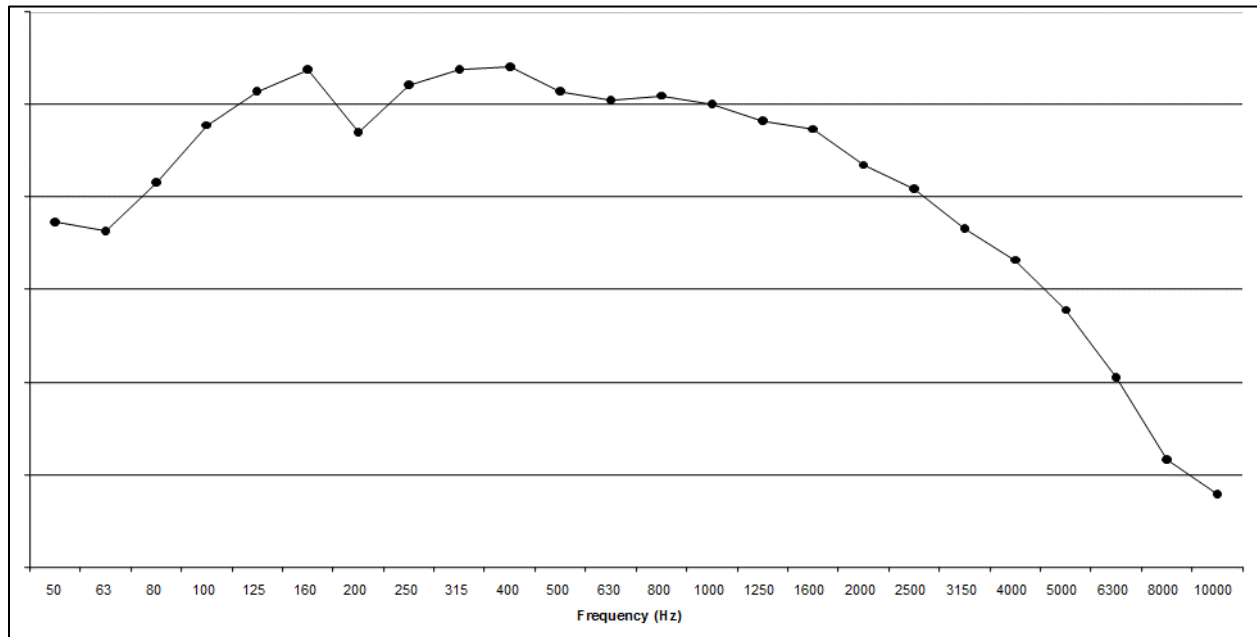

Figure 11-11 Departure Spectral Class 104

### 11.2.3 Performance and Acoustics

#### 11.2.3.1 AEDT Fleet Database Submittal Guidance for Fixed Wing Aircraft

##### 11.2.3.1.1 Data Submittal Overview

This section is a data request form for a submittal to the AEDT database. This database request form implements the fixed wing aircraft data requirements for a noise model as described in this report, as well as in the following supporting documents: SAE-AIR-1845<sup>3</sup>, ECAC Doc 29<sup>70</sup>, and ICAO Doc 9911<sup>67</sup>. The following describes the aircraft performance and noise data required for aircraft to be included in the ANP database. Additional guidance for developing aircraft performance and noise data submittals is found in SAE-AIR-1845<sup>3</sup> (see SAE-AIR-1845 Appendix A and Appendix B respectively).

##### 11.2.3.1.2 Reference Conditions for Performance and Noise Data

Table 11-14 presents the standard reference conditions that are used for the development of all aircraft performance and noise data submittals to the AEDT Fleet database. The use of these reference conditions during data development ensures consistency across the ANP database. It is important to note that different atmospheric conditions are referenced for developing aircraft performance and aircraft noise data.

Table 11-14 Reference Conditions for Performance Data

Wind	4 m/s headwind, constant with height above ground (8 knots)
Runway elevation	Mean Sea Level (MSL)
Runway gradient	None
Surface Air temperature	15°C (59°F)
Number of engines supplying thrust	All
Atmosphere	For performance: International Standard Atmosphere (ISA) For noise: SAE-AIR-1845 <sup>3</sup> reference atmosphere

The Jet thrust coefficients of Section 11.2.3.1.6 may be validated for conditions other than 15°C sea level. For these equations, it has been shown that coefficients may be developed for temperatures of 15°C to temperatures up to the engine break point and for takeoff altitudes of sea level up until 5,000 feet MSL.

Other input parameters such as rate-of-climb are not as flexible in their use and should be developed for a specific atmosphere. As per SAE-AIR-1845<sup>3</sup>, the default operating procedures described in Sections 11.2.3.1.7 and 11.2.3.1.8 will be provided for airports at 15°C, sea level condition assuming the International Standard Atmosphere. As an example, the parameters for rate-of-climb, target speed, and cutback height for a procedure will be developed specifically for sea level ISA.

#### 11.2.3.1.3 Aircraft and Engine Data

Where there are variations in certification weights and engine thrusts for a given model, provide data for the heaviest aircraft in terms of maximum gross takeoff weight in the model classification.

**NOTE:** Aircraft should reference a certification equivalent. Where there are variations in weight and engine thrusts for a given model, data for the heaviest aircraft that has been delivered in the model classification should be provided.

Table 11-15 General Aircraft and Engine Data Form

Aircraft model <sup>xliv</sup>			
Engine model*			
Number of engines			
Engine type (jet, turboprop, piston)			
Propeller model, if applicable*			
Engine Installation (tail- or wing-mounted)			
Noise stage number (2, 3, 4)			
Maximum static thrust (lb/engine)			
Automated thrust restoration (yes, no)			
Weight class (small, large, heavy)			
Maximum gross takeoff weight (lb)			
Maximum gross landing weight (lb)			
Maximum landing distance (ft)			
Reference Certification Levels (dB) <sup>xliv</sup>	TO:	SL:	AP:

#### 11.2.3.1.4 Guidance for Default Weights and Procedures

Default procedures should be developed for ranges suitable for representing the normal operating range of the aircraft. In this way, users may interpolate to other weights provided they have justification or other data. In the absence of more detailed data, users will resort to default weights corresponding to the trip length of the aircraft. Takeoff weights should be developed so as to increase with an increase in mission trip length. Weight assumptions should use industry planning assumptions for load factor, average passenger weight, excess cargo beyond passenger weight, and fuel required to complete mission trip length Table 11-20. Weights should be developed for the trip length ranges using the default mission planning rules below.

<sup>xliv</sup> As in the aircraft's type certificate.

<sup>xliv</sup> TO = takeoff; SL= sideline during takeoff; and AP = approach.

Table 11-16 Departure Takeoff Weights Form

Stage number	Trip length (nmi)	Representative Range (nmi)	Weight
1	0-500	350	lb
2	500-1,000	850	lb
3	1,000-1,500	1,350	lb
4	1,500-2,500	2,200	lb
5	2,500-3,500	3,200	lb
6	3,500-4,500	4,200	lb
7	4,500-5,500	5,200	lb
8	5,500-6,500	6,200	lb
9	6,500-7,500	7,200	lb
10	7,500-8,500	8,200	lb
11	>8,500		lb
M	Maximum range at MTOW		lb

The following guidance has been established to provide common mission planning rules for determining default weights to the stage lengths given in the table above. For stage length “M”, this is maximum range with maximum fuel and no additional cargo other than what is already included in the payload assumption.

Table 11-17 Guidance for Determining Departure Takeoff Weights

Parameter	Planning Rule
Representative Trip Length	Min Range + 0.70*(Max Range – Min Range)
Load Factor	65% Total Payload.
Fuel Load	Fuel Required for Representative Trip Length + ATA Domestic up to 3,000 nmi and International Reserves for trip length > 3,000 nmi.  As an example, typical domestics reserves include 5% contingency fuel, 200 nmi alternate landing with 30 minutes of holding.
Cargo	No additional cargo over and above the assumed payload percentage.

Not all trip lengths will be required for every aircraft as not all aircraft will be able to fly the higher trip length ranges. In addition to providing the trip length ranges for which an aircraft is able to fly, weights and procedures should also be developed for the aircraft maximum takeoff weight, MTOW, which is intended for modelling the maximum range (full fuel) of the aircraft. If relevant, a lower bound weight may also be provided that would be more representative of operations that would occur at weights below trip lengths of 350 nautical miles using the mission planning rules above.

11.2.3.1.5 Aerodynamic Coefficients

Aerodynamic coefficients for use with this methodology are required for available flap settings. The flap settings may be identified in degrees and abbreviations. Please provide data for all flap settings specified in Sections 11.2.3.1.7 and 11.2.3.1.8 and include separate coefficients per flap setting for cases with landing gear up and with landing gear down as appropriate.

Table 11-18 Aerodynamic Coefficients Form

Flap Configuration Identifier	Operation (A, D) <sup>xlvi</sup>	Gear	Takeoff B (ft/lb)	Takeoff C (kt/ $\sqrt{lb}$ )	Land D (kt/ $\sqrt{lb}$ ) <sup>xlvii</sup>	Drag/Lift R
	D	down				
	D	down				
	D	up				
	D	up				
	D	up				
	A	up				
	A	up				
	A	down				
	A	down				
	A	down				

11.2.3.1.6 Engine Coefficients

For jet aircraft, engine coefficients are required for maximum takeoff, maximum climb, and general thrust in terms of EPR or N1. The Max-Takeoff coefficients should be valid to 6,000 feet MSL, the Max-Climb, and General Thrust coefficients should be valid to 16,000 feet MSL. This is necessary so that the methodology accurately models operations at high altitude airports.

In addition, high temperature coefficients are required for operations above the thrust break temperature. AEDT uses the Max-Takeoff and Max-Climb coefficients below the breakpoint temperature and uses the Hi-Temp coefficients above the breakpoint temperature. The breakpoint temperature is at the intersection of the two curves. An example of Max-Takeoff and Hi-Temp Max-Takeoff curves is shown in Figure 11-12.

<sup>xlvi</sup> A = Approach, D = Depart

<sup>xlvii</sup> Not applicable.



Table 11-19 Jet Engine Coefficients Form

Thrust Type	E (lb)	F (lb/kt)	Ga (lb/ft)	Gb (lb/ft <sup>2</sup> )	H (lb/°C)
Max-Takeoff					
Hi-Temp Max-Takeoff					
Max-Climb					
Hi-Temp Max-Climb					
General Thrust					
Hi-Temp General Thrust					
	K1a (lb/EPR)	K1b (lb/EPR <sup>2</sup> )	or	K2 lb/(N1/√θ)	K3 lb/(N1/√θ) <sup>2</sup>
General Thrust					
Hi-Temp General Thrust					

Example of MAX and HI TEMP curves

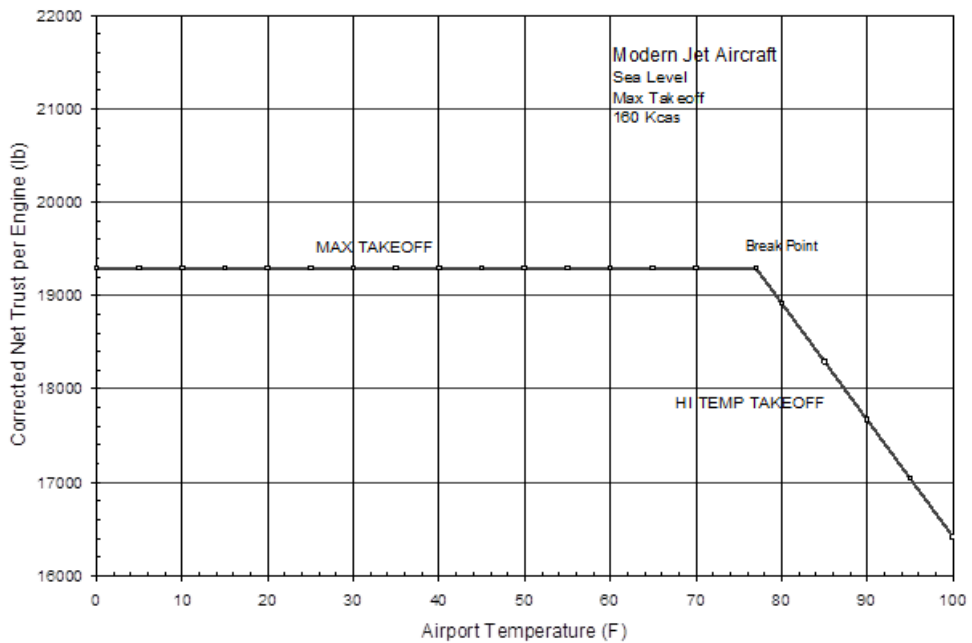

Figure 11-12 Example Maximum Takeoff Thrust vs. Temperature

For propeller-driven aircraft, engine coefficients are required for propeller efficiency and installed net propulsive power. Note that turboprop engine performance may be better modelled with the jet engine coefficients given above.

Table 11-20 Propeller Engine Coefficients Form

<b>Thrust Type</b>	<b>Propeller Efficiency</b>	<b>Installed net propulsive horsepower (hp)</b>
Max-Takeoff		
Max-Climb		

#### 11.2.3.1.7 Departure Procedures

Departure procedures consist of a takeoff segment, and a combination of climb and acceleration segments up to an altitude of 10,000 feet AFE. A climb segment is defined by its endpoint altitude. An acceleration segment is defined by its rate of climb and the calibrated airspeed (knots) at its endpoint. The flap settings are indicated for endpoints of segments. These flap settings should coincide with those given in Section 4 above. Please provide procedural data for each stage length given in Section 11.2.3.1.5 above.

Default takeoff procedures include an ICAO A, an ICAO B, and a BBN/AAAI reference procedure<sup>xlviii</sup>. Guidelines for the all three procedures are included below in Table 11-21. In developing these procedures, manufactures should use best judgment based on experience with their customers in determining a default takeoff flap setting and an appropriate power cutback point. Manufacturers of propeller-driven aircraft should use their own recommended procedures.

<sup>xlviii</sup> Historically, the BBN/AAAI reference procedure is known as the “DEFAULT” or “STANDARD” procedure.

Table 11-21 Default Takeoff Procedure Descriptions

<b>Default Procedure<sup>xlix</sup> Modified BBN/AAAI Procedure</b>	<b>ICAO A</b>	<b>ICAO B</b>
Takeoff at MaxToPower (full power) and Climb to 1,000 feet AFE	Takeoff MaxToPower (full power)	Takeoff at MaxToPower (full power)
Pitch over and cutback to climb power. Accelerate to zero flaps retracting flaps on schedule (clean configuration) <sup>l</sup>	Climb at constant speed to 1,500 feet AFE	Climb to 1,000 feet AFE and pitch-over to accelerate at full power to clean configuration
Climb at constant speed to 3,000 feet AFE	Reduce thrust to Climb Power	At Clean Configuration, cutback top climb power
	Climb at constant speed to 3,000 ft AFE	Climb at constant speed to 3,000 ft
Upon achieving 3,000 feet AFE, accelerate to 250 KCAS <sup>l</sup>	Accelerate while retracting flaps to zero (clean configuration)	Upon achieving 3,000 feet AFE, accelerate to 250 KCAS
	Continue accelerating to 250 KCAS	
Upon achieving 250 KCAS, climb to 10,000 feet AFE	Upon achieving 250 KCAS, climb to 10,000 feet	Upon achieving 250 KCAS, climb to 10,000 feet

The AEDT Fleet database supports two types of departure procedures: procedural profiles and profile points. Procedural profiles utilize aircraft performance methods, and they take into account atmospheric effects on the aircraft performance. Profile points are an ordered set of fixed profile points specifies a two-dimensional trajectory for the aircraft, and they do not take into account atmospheric effects on the aircraft performance. Procedural profiles are considered to be of a higher data quality than the profile points, because they allow for more modelling flexibility. Therefore, the development of procedural profiles is recommended. If possible, both procedural profiles and the corresponding profile point should be submitted for each submitted takeoff procedure, to aid in the review of the data submittal.

<sup>xlix</sup> In many cases, the “Default” procedure is the same as the ICAO B procedure. Manufacturers of propeller-driven aircraft should use their own recommended procedures.

<sup>l</sup> During acceleration steps, flaps are retracted on scheduled according to the published guidance for the airplane. Power is distributed between climb and acceleration according to the flight management system for the aircraft. This distribution between climb and acceleration should be provided as part of the data submission. As an example, a parameter of 55/45 would signify that 55% power would be for climb and 45% would be for acceleration .

Table 11-22 below should be completed for each submitted procedure (ICAO A, BBN/AAAI, etc.) over each takeoff weight given in Section 11.2.3.1.4. Table 11-24 should be completed for each corresponding submitted profile points. For both tables, the number and sequence of the procedure steps given below is for example purposes only and will vary depending on the aircraft and operating procedure. Additional information on CLIMB and ACCELERATION procedures steps is provided in Section 3.6.2.7.

Table 11-22 Takeoff Procedure Profile Form

Stage Number		Procedure Type (Procedural or Points)			Procedure Name	
Segment Type <sup>ii</sup>	Thrust Type <sup>iii</sup> (T/C)	Flap Configuration Identifier	Endpoint Altitude (ft AFE)	Rate-of-Climb (ft/min)	Endpoint Speed (KCAS)	Start Thrust <sup>liii</sup> (lb)
Takeoff						lb
Climb			ft			lb
Climb			ft			lb
Accelerate				fpm	kt	lb
Accelerate				fpm	kt	lb
Climb			ft			lb
Climb			ft			lb
Accelerate				fpm	kt	lb
Accelerate				fpm	kt	lb
Climb			10,000			lb

<sup>ii</sup> Add, delete, and sequence the segments as necessary to represent a takeoff procedure.

<sup>iii</sup> T = Max-Takeoff, C = Max-Climb, as defined in Section 10.2.3.1.6.

<sup>liii</sup> These data are used to compare to computed thrust values.

Table 11-23 Takeoff Profile Points Form

Stage Number		Procedure Type (Procedural or Points)			Procedure Name	
Profile Points	Segment Type	Thrust Type (T/C)	Start Altitude (ft AFE)	Horizontal Coordinate (ft) Relative to the start-roll point on a runway	Aircraft True Airspeed (KTAS)	Start Thrust (lb)
1	Takeoff		ft	ft	kt	lb
2	Climb		ft	ft	kt	lb
3	Climb		ft	ft	kt	lb
4	Accelerate		ft	ft	kt	lb
5	Accelerate		ft	ft	kt	lb
6	Climb		ft	ft	kt	lb
7	Climb		ft	ft	kt	lb
8	Accelerate		ft	ft	kt	lb
9	Accelerate		ft	ft	kt	lb
10	Climb		10,000 ft	ft	kt	lb

#### 11.2.3.1.8 Approach Procedures

A landing (or approach) profile should be calculated for a starting altitude of 10,000 feet above field elevation (AFE) following a 3 degree approach glide slope with a level segment at 3,000 feet AFE. The flap-setting identifiers should coincide with those given in Section 11.2.3.1.5 above. Reverse thrust distance is nominally 10% of ground roll distance, which is 90% of the stop distance minus 291 meters (954 feet). Reverse corrected net thrust is nominally 40% of maximum static thrust for narrow-body aircraft and 10% of maximum static thrust for wide-body aircraft. The idle/taxi distance is 90% of the stop distance minus 291 meters (954 feet). Stop distance can be smaller than the maximum landing distance reported in Section 11.2.3.1.3 above. Taxi/idle corrected net thrust is nominally 10% of maximum static thrust reported in Section 11.2.3.1.3 above.

Similar to the departure procedures, the ANP database supports both procedural profiles and profile points approach procedures. Procedural profiles are considered to be of a higher data quality than the profile points, because they allow for more modelling flexibility. Therefore, the development of procedural profiles is recommended. If possible, both procedural profiles and the corresponding profile point should be submitted for each submitted approach procedure, to aid in the review of the data submittal.

Table 11-24 below should be completed for each submitted landing procedure. Table 11-24 should be completed for each corresponding submitted profile points. For both tables, the number and sequence of the procedure steps given below is for example purposes only and will vary depending on the aircraft and operating procedure. Additional information on landing procedures steps is provided in Section 3.6.2.7.

Table 11-24 Approach Procedure Profile Form

Landing Weight (lb)					Stopping Distance (ft)			
Procedure Type (Procedural or Points)					Procedure Name			
Profile Point	Operation	Starting Flap Configuration	Starting Altitude (ft AFE)	Decent Angle (deg)	Start Speed <sup>liv</sup> (KCAS)	Track Distance (Horizontal Length) (ft)	Start Thrust (% of static thrust)	Start Thrust <sup>lv</sup> (lb)
1	Descend							
2	Descend							
3	Descend							
4	Level-Decel							
5	Descend							
6	Land							
7	Decelerate							
8	Decelerate					0 ft		

Table 11-25 Approach Profile Points Form

Landing Weight (lb)			Stopping Distance (ft)		
Procedure Type (Procedural or Points)			Procedure Name		
Profile Points	Segment Type	Start Altitude (AFE)	Horizontal Coordinate (ft) Relative to the touchdown point <sup>lvi</sup>	Aircraft True Airspeed (KTAS)	Start Thrust
1	Descend	ft	ft	kt	lb
2	Descend	ft	ft	kt	lb
3	Level-Decel	ft	ft	kt	lb
4	Descend	ft	ft	kt	lb
5	Land	0 ft	0 ft	kt	lb
6	Decelerate	0 ft	ft	kt	lb
7	Decelerate	0 ft	ft	kt	lb

#### 11.2.3.1.9 Noise Data

Noise Power Distance (NPD) data are requested for noise exposure levels (Sound Exposure Level and Effective Perceived Noise Level) and maximum noise levels (Maximum A-weighted Sound Level and Maximum Tone-Corrected Perceived Noise Level). Specific guidelines<sup>3</sup> are followed for developing NPD data. NPDs should be provided for representative corrected net thrust values that span the procedures given in Sections 11.2.3.1.7 and 11.2.3.1.8. In general, noise measurements are collected under certification-like conditions and then are adjusted to different distances based on spherical divergence, altitude, duration, time-varying aircraft speed, and atmospheric absorption. Where applicable, be sure to differentiate between approach and takeoff configuration noise data. For example, "6000-A" would be 6,000 lb. of corrected net thrust under approach configuration.

Two different SEL NPD calculation adjustment procedures<sup>3</sup>: the integrated procedure and the simplified procedure. The integrated procedure requires a higher quality of data, where measured noise and performance data include spectral data available for the complete flyover time period of interest, whereas the simplified procedure is typical used with measured noise and performance data where spectral data are available only for the time of occurrence of the maximum sound level. The integrated procedure is recommended for computing NPDs for the data submittal form, although NPDs computed using either integrated or simplified will be accepted. Where applicable, be sure to differentiate between NPDs generated using integrated and simplified procedures.

In general, noise measurements are collected under certification-like conditions and then are adjusted to different distances based on spherical divergence, altitude, duration, time-varying aircraft speed, and atmospheric absorption. Noise data should be normalized to standard reference conditions specified in Section 11.2.3.1.2. Where applicable, be sure to differentiate between approach and takeoff configuration noise data. For example, "6000-A" would be 6,000 lb. of corrected net thrust under approach configuration.

It is important to note that SAE-AIR-1845<sup>3</sup> references SAE-ARP-866A<sup>2</sup> for computing the atmospheric absorption adjustment during the NPD computation process. As mentioned in Section 11.1.4, SAE-ARP-5534<sup>4</sup> is being evaluated for use with noise certification, and is intended to replace SAE-ARP-866A<sup>2</sup>. In the meantime, the effects of study or airport-specific atmospheric conditions (temperature, relative humidity and atmospheric pressure) on noise levels may be accounted for using an atmospheric absorption adjustment as defined by either SAE-ARP-5534<sup>4</sup> or SAE-ARP-866A<sup>2</sup> in the noise modelling. When developing NPDs from empirical data, SAE-ARP-866A<sup>2</sup> should still be used to correct the empirical data to the source using the measurement day atmospheric conditions, and the reference atmospheric

---

<sup>liv</sup> Landing speed is for reference only; ICAO Doc 9911<sup>67</sup> methods calculate landing speed using the D coefficient and landing weight.

<sup>lv</sup> These data are used to compare to computed thrust values.

<sup>lvi</sup> These horizontal coordinate values are negative during descent and positive during the landing ground roll.



adjustment (in Section 11.1.4) should be used to compute the noise levels at the ten NPD distances using standard atmospheric conditions, as specified in SAE-AIR-1845<sup>3</sup>.

Noise data for approach conditions should use the final approach landing speed as the reference speed for the noise data. All exposure based metrics such as EPNL and SEL should be further normalized to 160 knots using the duration correction equation<sup>3</sup>.

Sound exposure levels should be calculated for the distances given on the tables, below which range from 200 feet to 25,000 feet. SEL values less than 75 dB at 1,000 feet may require additional extrapolation and may not be consistently derived or accessed for accuracy across all aircraft types. When modelling propeller aircraft, the propeller rotations per minute (RPM) should also be provided for each NPD.

Repeat Table 11-26 for each combination of noise type and operation (8 tables). Where applicable, be sure to differentiate between approach and takeoff configuration noise data. In each table, a minimum of two NPDs per operation mode and noise type is required, in order to have the minimum number of NPDs required for NPD interpolation and extrapolation as described in Section 4.2.2. The development of more than 2 NPDs for each combination of noise type and operation mode is strongly recommended. A larger NPD data set results in both the noise levels of the aircraft being more comprehensively represented, and noise levels being extrapolated over smaller ranges, thus improving the accuracy of the noise model utilizing those data. It is not uncommon for aircraft in the ANP database to have 3 or 4 approach NPDs and 6 or more departure NPDs for each noise metric type.

Table 11-26 NPD Data Form

<b>Noise Type<sup>lvii</sup></b>		<b>Operation<sup>lviii</sup></b>				
Atmospheric Absorption Method (SAE-ARP-5534 <sup>4</sup> or SAE-ARP-866A <sup>2</sup> )		SAE-AIR-1845 <sup>3</sup> Integrated or Simplified Procedure				
Distance (ft)	Corrected Net Thrust per Engine (lb)					
	lb	lb	lb	lb	lb	lb
	RPM	RPM	RPM	RPM	RPM	RPM
200	dB	dB	dB	dB	dB	dB
400	dB	dB	dB	dB	dB	dB
630	dB	dB	dB	dB	dB	dB
1,000	dB	dB	dB	dB	dB	dB
2,000	dB	dB	dB	dB	dB	dB
4,000	dB	dB	dB	dB	dB	dB
6,300	dB	dB	dB	dB	dB	dB
10,000	dB	dB	dB	dB	dB	dB
16,000	dB	dB	dB	dB	dB	dB
25,000	dB	dB	dB	dB	dB	dB

Unweighted one-third octave-band spectral data corresponding to the time of  $L_{PNTS_{mx}}$  and the time of  $L_{AS_{mx}}$  should be provided for each thrust level represented in the NPDs. The spectra should be at the same corrected net thrust values as provided in the noise exposure and maximum noise tables, and span the one-third octave-bands from 50 to 10,000 Hz<sup>lix</sup>. The spectra should be measured at a speed close to 160 kts and adjusted to a reference distance of 1,000 feet using the atmospheric absorption.

**lvii NOISE TYPES:**

- LAE = Sound Exposure Level (reference speed 160 kts)
- LEPN = Effective Perceived Noise Level (reference speed 160 kts)
- LAS<sub>mx</sub> = Maximum A-weighted Sound Level (at speed close to 160 knots)
- LPNTS<sub>mx</sub> = Maximum Tone-Corrected Perceived Noise Level (at speed close to 160 knots)

**lviii OPERATIONS:**

- A = Approach
- D = Depart

lix Note: if one-third octave-band spectral data are available at frequencies below 50 Hz (e.g., 20 Hz to 50 Hz), they should also be submitted, in order to support the enhancement of low frequency noise computation capabilities in future releases of AEDT.

Repeat Table 11-27 for each combination of noise type and operation (4 tables). Where applicable, be sure to differentiate between approach and takeoff configuration noise data.

Table 11-27 Spectral Data Form

Noise Type <sup>lx</sup>		Operation				
One-Third Octave Band (Hz)	Corrected Net Thrust per Engine (lb)					
	lb	lb	lb	lb	lb	lb
50	dB	dB	dB	dB	dB	dB
63	dB	dB	dB	dB	dB	dB
80	dB	dB	dB	dB	dB	dB
100	dB	dB	dB	dB	dB	dB
125	dB	dB	dB	dB	dB	dB
160	dB	dB	dB	dB	dB	dB
200	dB	dB	dB	dB	dB	dB
250	dB	dB	dB	dB	dB	dB
315	dB	dB	dB	dB	dB	dB
400	dB	dB	dB	dB	dB	dB
500	dB	dB	dB	dB	dB	dB
630	dB	dB	dB	dB	dB	dB
800	dB	dB	dB	dB	dB	dB
1,000	dB	dB	dB	dB	dB	dB
1,250	dB	dB	dB	dB	dB	dB
1,600	dB	dB	dB	dB	dB	dB
2,000	dB	dB	dB	dB	dB	dB
2,500	dB	dB	dB	dB	dB	dB
3,150	dB	dB	dB	dB	dB	dB
4,000	dB	dB	dB	dB	dB	dB
5,000	dB	dB	dB	dB	dB	dB
6,300	dB	dB	dB	dB	dB	dB
8,000	dB	dB	dB	dB	dB	dB
10,000	dB	dB	dB	dB	dB	dB

<sup>lx</sup> At time of L<sub>ASmx</sub> and L<sub>PNTSmx</sub>

### 11.2.3.2 AEDT Database Submittal Form for Propeller-Driven, Fixed-Wing Aircraft

This section is a data request form for a submittal to the AEDT database. Since the form in Section 11.2.3.1 may be used for either jet or propeller fixed-wing aircraft, it is formatted to allow for the entry of information that may be extraneous for propeller aircraft.

Therefore, an abbreviated version of that form specific to propeller-driven aircraft is presented in Section 11.2.3.2. It is intended for the submittal of propeller-driven, fixed-wing aircraft noise and performance data for the AEDT database.

#### 11.2.3.2.1 Reference Conditions For Performance Data

As per SAE-AIR-1845<sup>3</sup>, the default operating procedures described in Section 11.2.3.2.4 will be provided for airports at 15°C, sea level condition assuming the ISA. As an example, the parameters for rate-of-climb, target speed, and cutback height for a procedure will be developed specifically for sea level ISA.

Table 11-28 Reference Conditions for Performance Data

Wind	4 m/s (8 kts) headwind, constant with height above ground
Runway elevation	Mean Sea Level (MSL)
Runway gradient	None
Surface Air temperature	15°C (59°F)
Number of engines supplying thrust	All
Atmosphere	For performance: International Standard Atmosphere (ISA) For noise: SAE-AIR-1845 <sup>3</sup> atmosphere

#### 11.2.3.2.2 Aircraft and Engine Data

Where there are variations in certification weights and engine thrusts for a given model, provide data for the heaviest aircraft in terms of maximum gross takeoff weight in the model classification.

**NOTE:** Aircraft should reference a certification equivalent. Where there are variations in weight and engine power settings for a given model, data for the heaviest aircraft that has been delivered in the model classification should be provided. Furthermore, power should be presented in the form of horsepower.

Table 11-29 General Aircraft and Engine Data Form

Aircraft model <sup>lxi</sup>			
Engine model*			
Number of engines			
Engine type (jet, turboprop, piston)			
Propeller model*			
Engine Installation (tail- or wing-mounted)			
Noise stage number (2, 3, 4)			
Sea Level rated HP (per engine)			
Automated thrust restoration (yes, no)			
Weight class (small, large, heavy)			
Maximum gross takeoff weight (lb)			
Maximum gross landing weight (lb)			
Maximum landing distance (ft)			
14 CFR Part 36 Reference Certification Levels <sup>lxii</sup> , either:			
(a) Appendix B, or	TO:	SL:	AP:
(b) Appendix G	TO:		

11.2.3.2.3 Guidance for Default Weights and Procedures

Default procedures should be developed for ranges suitable for representing the normal operating range of the aircraft. In this way, users may interpolate to other weights provided they have justification or other data. In the absence of more detailed data, users will resort to default weights corresponding to the trip length of the aircraft. Takeoff weights should be developed so as to increase with an increase in mission trip length. Weight assumptions should use industry planning assumptions for load factor, average passenger weight, excess cargo beyond passenger weight, and fuel required to complete mission trip length. Weights should be developed for the trip length ranges using the default mission planning rules below. Stage “M” represents the maximum trip length (in nmi) of the individual aircraft at MTOW, and it should be submitted separately, even if the maximum trip length falls within one of the other stage number categories.

<sup>lxi</sup> As in the Aircraft’s type certificate.

<sup>lxii</sup> TO = takeoff; SL = sideline; and AP = Approach.

Table 11-30 Departure Takeoff Weights Form

Stage number	Trip length (nmi)	Representative Range	Weight
1	0-500	350	lb
2	500-1,000	850	lb
3	1,000-1,500	1,350	lb
4	1,500-2,500	2,200	lb
5	2,500-3,500	3,200	lb
6	3,500-4,500	4,200	lb
7	4,500-5,500	5,200	lb
8	5,500-6,500	6,200	lb
9	6,500-7,500	7,200	lb
10	7,500-8,500	8,200	lb
11	>8,500		lb
M	Maximum range at MTOW		lb

The following guidance has been established to provide common mission planning rules for determining default weights to the stage lengths given in the table above. For stage length "M", this is maximum range with maximum fuel and no additional cargo other than what is already included in the payload assumption.

Table 11-31 Guidance for Determining Departure Takeoff Weights

Parameter	Planning Rule
Representative Trip Length	Min Range + 0.70*(Max Range – Min Range)
Load Factor	65% Total Payload.
Fuel Load	Fuel Required for Representative Trip Length + ATA Domestic up to 3,000 nmi and International Reserves for trip length > 3,000 nmi.  As an example, typical domestics reserves include 5% contingency fuel, 200 nmi alternate landing with 30 minutes of holding.
Cargo	No additional cargo over and above the assumed payload percentage.

Not all nine trip lengths will be required for every aircraft as not all aircraft will be able to fly the higher trip length ranges. In addition to providing the trip length ranges for which an aircraft is able to fly, weights and procedures should also be developed for the aircraft MTOW, which is intended for modelling the maximum range (full fuel) of the aircraft. If relevant, a lower bound weight may also be

provided that would be more representative of operations that would occur at weights below trip lengths of 350 nmi using the mission planning rules above.

11.2.3.2.4 Aerodynamic Coefficients

Aerodynamic coefficients for use with the SAE-AIR-1845<sup>3</sup> equations are required for available flap settings. The flap settings may be identified in degrees and/or abbreviations. Please provide data for all flap settings specified in Sections 11.2.3.2.5 and 11.2.3.2.6, and include separate coefficients per flap setting for cases with landing gear up and with landing gear down as appropriate. Fixed gear aircraft do not require gear position information.

Table 11-32 Aerodynamic Coefficients Form

Flap Configuration Identifier	Operation (A, D) <sup>lxiii</sup>	Gear	Takeoff B (ft/lb)	Takeoff C (kt/vlb)	Land D (kt/vlb)	Drag/Lift R
	D	down				
	D	down				
	D	up				
	D	up				
	D	up				
	A	up				
	A	up				
	A	down				
	A	down				
	A	down				

11.2.3.2.5 Engine Coefficients

For propeller-driven aircraft, engine coefficients in accordance with SAE-AIR-1845<sup>3</sup> equations are required for propeller efficiency and installed net propulsive power. In many cases, turboprop engine performance may be better modeled with the jet engine coefficients given in Section 11.2.3.1.

**NOTE:** the current version of the AEDT uses the Max-Climb power setting from the thrust reduction point up to 10,000 feet AFE. If the aircraft engine is flat-rated, no change is required. If the engine is normally aspirated, the average power in the climb should be used. Propeller efficiencies should also be averaged over the conditions when the different power settings are used.

<sup>lxiii</sup> A = Approach, D = Depart

Table 11-33 Propeller Engine Coefficients Form

Power Setting	Propeller Efficiency	Installed net propulsive horsepower (hp)
Max-Takeoff		
Max-Climb		

#### 11.2.3.2.6 Departure Procedures

Departure procedures consist of a takeoff segment, and a combination of climb and acceleration segments up to an altitude of 10,000 feet AFE. A climb segment is defined by its endpoint altitude. An acceleration segment is defined by its rate-of-climb and the calibrated airspeed (knots) at its endpoint. The flap settings are indicated for endpoints of segments. These flap settings should coincide with those given in Section 11.2.3.2.3 above. Please provide procedural data for each stage length given in Section 11.2.3.2.2 above.

Default takeoff procedures for jet aircraft include an ICAO A, an ICAO B, and a BBN/AAAI reference procedure, included in Section 11.2.3.1 in Table 11-21. However, these procedures may not be appropriate for propeller-driven aircraft. Manufacturers of propeller-driven aircraft should use their own recommended procedures. In developing these procedures, manufactures should use best judgment based on experience with their customers in determining a default takeoff flap setting and an appropriate power cutback point.

The ANP database supports two types of departure procedures: procedural profiles and profile points. Procedural profiles utilize aircraft performance methods, and they take into account atmospheric effects on the aircraft performance. Profile points are an ordered set of fixed profile points specifies a two-dimensional trajectory for the aircraft, and they do not take into account atmospheric effects on the aircraft performance. Procedural profiles are considered to be of a higher data quality than the profile points, because they allow for more modelling flexibility. Therefore, the development of procedural profiles is recommended. If possible, both procedural profiles and the corresponding profile point should be submitted for each submitted takeoff procedure, to aid in the review of the data submittal.

Table 11-34 below should be completed for each submitted procedural profile verses each takeoff weight given in Section 11.2.3.2.3. The number and sequence of the Doc 9911 procedure steps given below is for example purposes only and will vary depending on the aircraft and operating procedure. Database submittals should comply with manufacturer's recommended departure procedures. Additional information on CLIMB and ACCELERATION procedures steps is provided in SAE-AIR-1845<sup>3</sup>. Note, certain SAE parameters such as rate-of-climb are not flexible in their use and should be developed for a specific atmosphere.



Table 11-34 Takeoff Procedural Profile Form

Stage Number		Procedure Type (Procedural or Points)			Procedure Name		
Profile Steps	Segment Type <sup>lxiv</sup>	Thrust Type <sup>lxv</sup> (T/C)	Flap Configuration Identifier	Endpoint Altitude (ft AFE)	Rate-of-Climb (ft/min)	Endpoint Speed (KCAS)	Start Thrust <sup>lxvi</sup> (lb or %hp)
1	Takeoff			N/A	N/A	N/A	
2	Climb			ft	N/A	N/A	
3	Climb			ft	N/A	N/A	
4	Accelerate			N/A	ft/min	kt	
5	Accelerate			N/A	ft/min	kt	
6	Climb			ft	N/A	N/A	
7	Climb			ft	N/A	N/A	
8	Accelerate			N/A	ft/min	kt	
9	Accelerate			N/A	ft/min	kt	
10	Climb			10,000 ft	N/A	N/A	lb

<sup>lxiv</sup> Add, delete, and sequence the segments as necessary to represent a takeoff procedure.

<sup>lxv</sup> T = Max-Takeoff, C = Max-Climb.

<sup>lxvi</sup> Start thrust data may be presented in either corrected net thrust (lb) or percent horsepower (%hp). These data are used to compare to computed thrust values.

Table 11-35 Takeoff Profile Points Form

Stage Number		Procedure Type (Procedural or Points)			Procedure Name	
Profile Points	Segment Type	Thrust Type (T/C)	Start Altitude (ft AFE)	Horizontal Coordinate (m) Relative to the start-roll point on a runway	Aircraft True Airspeed (KTAS)	Start Thrust (lb or %hp)
1	Takeoff		ft	ft	kt	lb
2	Climb		ft	ft	kt	lb
3	Climb		ft	ft	kt	lb
4	Accelerate		ft	ft	kt	lb
5	Accelerate		ft	ft	kt	lb
6	Climb		ft	ft	kt	lb
7	Climb		ft	ft	kt	lb
8	Accelerate		ft	ft	kt	lb
9	Accelerate		ft	ft	kt	lb
10	Climb		10,000 ft	ft	kt	lb

#### 11.2.3.2.7 Approach Procedures

A landing profile should be calculated for a starting altitude of 10,000 feet AFE following a 3 degree approach glide slope with a level segment at 3,000 ft AFE. The flap-setting identifiers should coincide with those given in Section 11.2.3.2.3 above. Reverse thrust distance is nominally 10% of ground roll distance, which is 90% of the stop distance minus 291 m (954 ft), if applicable. Stop distance can be smaller than the maximum landing distance reported in Section 11.2.3.2.2. Reverse corrected net thrust is nominally 40% of maximum static thrust for narrow-body aircraft and 10% of maximum static thrust for wide-body aircraft. The idle/taxi distance is 90% of the stop distance minus 291 meters (954 ft). Taxi/idle corrected net thrust is nominally 10% of maximum static thrust reported in Section 11.2.3.2.2.

Similar to the departure procedures, the ANP database supports both procedural profiles and profile points approach procedures. Procedural profiles are considered to be of a higher data quality than the profile points, because they allow for more modelling flexibility. Therefore, the development of procedural profiles is recommended. If possible, both procedural profiles and the corresponding profile point should be submitted for each submitted approach procedure, to aid in the review of the data submittal.

Table 11-36 below should be completed for each submitted landing procedure. Table 11-37 should be completed for each corresponding submitted profile points. For both tables, the number and sequence of the procedure steps given below is for example purposes only and will vary depending on the aircraft and operating procedure. Additional information on landing procedures steps is provided in Section 3.6.2.7.

Table 11-36 Approach Procedural Profile Form

Landing Weight (lb)					Stopping Distance (ft)			
Procedure Type (Procedural or Points)					Procedure Name			
Profile Step	Operation	Starting Flap Configuration	Starting Altitude (ft AFE)	Decent Angle (deg)	Start Speed <sup>lxvii</sup> (KCAS)	Track Distance (Horizontal Length) (ft)	Start Thrust (% of static thrust)	Start Thrust <sup>lxviii</sup> (lb or %hp)
1	Descend		ft		kt			lb
2	Descend		ft		kt			lb
3	Descend		ft		kt			lb
4	Level-Decel		ft		kt	ft		lb
5	Descend		ft		kt			lb
6	Land		0 ft			ft		lb
7	Decelerate		0 ft		kt	ft		lb
8	Decelerate		0 ft		kt	0 ft		lb

<sup>lxvii</sup> Landing speed is for reference only; ICAO Doc 9911<sup>67</sup> methods calculate landing speed using the D coefficient and landing weight.

<sup>lxviii</sup> These data are used to compare to computed thrust values.

Table 11-37 Approach Profile Points Form

Landing Weight (lb)			Stopping Distance (ft)		
Procedure Type (Procedural or Points)			Procedure Name		
Profile Points	Segment Type	Start Altitude (ft AFE)	Horizontal Coordinate (m) Relative to the touchdown point <sup>lxix</sup>	Aircraft True Airspeed (KTAS)	Start Thrust (lb or %hp)
1	Descend	ft	ft	kt	lb
2	Descend	ft	ft	kt	lb
3	Descend	ft	ft	kt	lb
4	Level-Decel	ft	ft	kt	lb
5	Descend	ft	ft	kt	lb
6	Land	0 ft	0 ft	kt	lb
7	Decelerate	0 ft	ft	kt	lb
8	Decelerate	0 ft	ft	kt	lb

#### 11.2.3.2.8 Noise Data

NPD data are requested for noise exposure levels (Sound Exposure Level and Effective Perceived Noise Level) and maximum noise levels (Maximum A-weighted Sound Level and Maximum Tone-Corrected Perceived Noise Level). Specific guidelines for developing NPD data are provided in SAE-AIR-1845<sup>3</sup>. NPDs should be provided for representative corrected net thrust values that span the procedures given in Section 11.2.3.2.5 and Section 11.2.3.2.6. Corrected net thrust for propeller-driven aircraft should be calculated using the SAE-AIR-1845<sup>3</sup> equations (see Section 3.6.2.2.2) and the coefficients provided in this data submittal. In general, noise measurements are collected under certification-like conditions and then are adjusted to different distances based on spherical divergence, altitude, duration, time-varying aircraft speed, and atmospheric absorption. Where applicable, be sure to differentiate between approach and takeoff configuration noise data. For example, "200-A" would be 200 lb. of corrected net thrust per engine under approach configuration.

Two different SEL NPD calculation adjustment procedures are defined in SAE-AIR-1845<sup>3</sup>: the integrated procedure and the simplified procedure. The integrated procedure requires a higher quality of data, where measured noise and performance data include spectral data available for the complete flyover time period of interest, whereas the simplified procedure is typical used with measured noise and

<sup>lxix</sup> These horizontal coordinate values are negative during descent and positive during the landing ground roll.

performance data where spectral data are available only for the time of occurrence of the maximum sound level. The integrated procedure is recommended for computing NPDs for the data submittal form, although NPDs computed using either integrated or simplified will be accepted. Where applicable, be sure to differentiate between NPDs generated using integrated and simplified procedures.

In general, noise measurements are collected under certification-like conditions and then are adjusted to different distances based on spherical divergence, altitude, duration, time-varying aircraft speed, and atmospheric absorption. Noise data should be normalized to standard reference conditions specified in Section 11.2.3.2.1. Where applicable, be sure to differentiate between approach and takeoff configuration noise data. For example, "200-A" would be 200 lb of corrected net thrust per engine under approach configuration.

It is important to note that SAE-AIR-1845<sup>3</sup> references SAE-ARP-866A<sup>2</sup> for computing the atmospheric absorption adjustment during the NPD computation process. As mentioned in Section 4.3.1 SAE-ARP-5534<sup>4</sup> is being evaluated for use with noise certification, and is intended to replace SAE-ARP-866A<sup>2</sup>. In the meantime, the effects of study or airport-specific atmospheric conditions (temperature, relative humidity and atmospheric pressure) on noise levels may be accounted for using an atmospheric absorption adjustment as defined by either SAE-ARP-5534<sup>4</sup> or SAE-ARP-866A<sup>2</sup> in the noise modelling. When developing NPDs from empirical data, SAE-ARP-866A<sup>2</sup> should still be used to correct the empirical data to the source using the measurement day atmospheric conditions, and the reference atmospheric adjustment in Section 11.1.4 should be used to compute the noise levels at the ten NPD distances using standard atmospheric conditions, as specified in SAE-AIR-1845<sup>3</sup>.

Noise data for approach conditions should use the final approach landing speed as the reference speed for the noise data. All exposure based metrics such as EPNL and SEL should be further normalized to 160 knots using the duration correction equation in SAE-AIR-1845<sup>3</sup>.

Sound exposure levels should be calculated for the distances given on the tables, below which range from 200 feet to 25,000 feet. When modelling propeller aircraft, the propeller rotations per minute (RPM) should also be provided for each NPD.

Unweighted one-third octave-band spectral data corresponding to the time of  $L_{PNTS_{max}}$  and the time of  $L_{AS_{max}}$  should be provided for each thrust level represented in the NPDs. The spectral data should be measured at a reference distance of 1,000 ft, and span the one-third octave-bands from 50 to 10,000 Hz. Where applicable, be sure to differentiate between approach and takeoff configuration noise data.

Repeat Table 11-38 for each combination of noise type and operation mode (8 tables). Where applicable, be sure to differentiate between approach and takeoff configuration noise data. In each table, a minimum of two NPDs per operation mode and noise type is required, in order to have the minimum number of NPDs required for NPD interpolation and extrapolation as described in Section 11.1.4. The development of more than 2 NPDs for each combination of noise type and operation mode is strongly recommended. A larger NPD data set results in both the noise levels of the aircraft being more comprehensively represented, and noise levels being extrapolated over smaller ranges, thus

improving the accuracy of the noise model utilizing those data. It is not uncommon for aircraft in the ANP database to have 3 or 4 approach NPDs and 6 or more departure NPDs for each noise metric type.

Table 11-38 NPD Data Form

Noise Type <sup>lxx</sup>		Operation <sup>lxxi</sup>					
Atmospheric Absorption Method (SAE-ARP-5534 <sup>4</sup> or SAE-ARP-866A <sup>2</sup> )		SAE-AIR-1845 <sup>3</sup> Integrated or Simplified Procedure					
Distance (ft)	Power Setting (lb or %hp)						
	lb	lb	lb	lb	lb	lb	
	RPM	RPM	RPM	RPM	RPM	RPM	
200	dB	dB	dB	dB	dB	dB	
400	dB	dB	dB	dB	dB	dB	
630	dB	dB	dB	dB	dB	dB	
1,000	dB	dB	dB	dB	dB	dB	
2,000	dB	dB	dB	dB	dB	dB	
4,000	dB	dB	dB	dB	dB	dB	
6,300	dB	dB	dB	dB	dB	dB	
10,000	dB	dB	dB	dB	dB	dB	
16,000	dB	dB	dB	dB	dB	dB	
25,000	dB	dB	dB	dB	dB	dB	

Unweighted one-third octave-band spectral data corresponding to the time of  $L_{PNTS_{mx}}$  and the time of  $L_{AS_{mx}}$  should be provided for each thrust level represented in the NPDs. The spectra should be at the same corrected net thrust values as provided in the noise exposure and maximum noise tables, and

**lxx NOISE TYPES:**

- LAE = Sound Exposure Level (reference speed 160 knots)
- LEPN = Effective Perceived Noise Level (reference speed 160 knots)
- LAS<sub>mx</sub> = Maximum A-weighted Sound Level (at speed close to 160 knots)
- LPNTS<sub>mx</sub> = Maximum Tone-Corrected Perceived Noise Level (at speed close to 160 knots)

**lxxi OPERATIONS:**

- A = Approach
- D = Depart

span the one-third octave-bands from 50 to 10,000 Hz<sup>lxxii</sup>. The spectra should be measured at a speed close to 160 knots, if possible, and adjusted to a reference distance of 1,000 feet using the atmospheric absorption table in Section 11.1.4. Repeat Table 11-39 for each combination of noise type and operation (4 tables). Where applicable, be sure to differentiate between approach and takeoff configuration spectral data.

---

<sup>lxxii</sup> Note: if one-third octave-band spectral data are available at frequencies below 50 Hz (e.g., 20 Hz to 50 Hz), they should also be submitted, in order to support the enhancement of low frequency noise computation capabilities in future releases of AEDT.

Table 11-39 Spectral Data Form

Noise Type <sup>lxxiii</sup>		Operation				
One-Third Octave Band (Hz)	Corrected Net Thrust per Engine (lb)					
	lb	lb	lb	lb	lb	lb
50	dB	dB	dB	dB	dB	dB
63	dB	dB	dB	dB	dB	dB
80	dB	dB	dB	dB	dB	dB
100	dB	dB	dB	dB	dB	dB
125	dB	dB	dB	dB	dB	dB
160	dB	dB	dB	dB	dB	dB
200	dB	dB	dB	dB	dB	dB
250	dB	dB	dB	dB	dB	dB
315	dB	dB	dB	dB	dB	dB
400	dB	dB	dB	dB	dB	dB
500	dB	dB	dB	dB	dB	dB
630	dB	dB	dB	dB	dB	dB
800	dB	dB	dB	dB	dB	dB
1,000	dB	dB	dB	dB	dB	dB
1,250	dB	dB	dB	dB	dB	dB
1,600	dB	dB	dB	dB	dB	dB
2,000	dB	dB	dB	dB	dB	dB
2,500	dB	dB	dB	dB	dB	dB
3,150	dB	dB	dB	dB	dB	dB
4,000	dB	dB	dB	dB	dB	dB
5,000	dB	dB	dB	dB	dB	dB
6,300	dB	dB	dB	dB	dB	dB
8,000	dB	dB	dB	dB	dB	dB
10,000	dB	dB	dB	dB	dB	dB

**11.2.3.3 AEDT Fleet Database Submittal Form for Helicopters**

This section is a data request form for a submittal to the AEDT database. The following form describes the performance and noise data required for helicopters to be included in the AEDT Fleet database.

<sup>lxxiii</sup> At time of L<sub>ASmx</sub> and L<sub>PNTSmx</sub>.



### 11.2.3.3.1 Reference Conditions for Performance Data

Helicopter noise data required for use in the AEDT should be corrected for the conditions contained in the following table:

Table 11-40 Reference Conditions for Performance Data

Wind	Zero
Runway/helipad elevation	Mean Sea Level (MSL)
Number of engines supplying thrust	All
Atmosphere	For performance: International Standard Atmosphere (ISA) For noise: SAE-AIR-1845 <sup>3</sup> atmosphere

### 11.2.3.3.2 Aircraft and Engine Data

Where there are variations in certification weights for a given model, provide data for the heaviest aircraft in terms of maximum gross takeoff weight in the model classification.

**NOTE:** Aircraft should reference a certification equivalent. Where there are variations in weight for a given model, data for the heaviest aircraft that has been delivered in the model classification should be provided.

Table 11-41 General Helicopter and Engine Data Form

Helicopter model				
Description				
Owner category <sup>lxxiv</sup>				
Engine type ('turboshaft', 'piston')				
Number of main rotor blades				
Main rotor diameter (ft)				
Rotor speed (RPM)				
Maximum gross takeoff weight (lb)				
Wheels ('yes' or 'no')				
Engine model				
Number of rotors (main plus tail)				
Maximum Speed in Level Flight w/ Maximum Continuous Power, $V_H$ (kt)				
Speed for Best Rate of Climb, $V_Y$ (kt)				
Never Exceed Speed, $V_{NE}$ (kt)				
14 CFR Part 36 Reference Certification Levels <sup>lxxv</sup> , either:				
(a) Appendix H, or	TO:	SL:	AP:	LF:
(b) Appendix J	TO:			LF:

11.2.3.3.3 Speed Coefficients

$B_0$ ,  $B_1$ , and  $B_2$  are regression coefficients used in the calculation of a source-noise correction for level flight only, and are applied to the left, center and right NPDs. The correction accounts for changes in sound level associated with the deviation of advancing blade Mach number from that associated with the source data reference conditions. The coefficients are derived using a least-squares, 2<sup>nd</sup> order regression through measured  $L_{PNTS_{mx}}$  data as a function of test speed.

To determine the sound level correction in AEDT, the relationship between the  $PNLT_{max}$  (usually as-measured or corrected for distance) and the difference between the test  $M_{ADV}$  and the AEDT reference  $M_{ADV}$  ( $\Delta(M_{ADV\_T} - M_{ADV\_R})$ , computed using Eq. 4-58] must be determined. This relationship usually takes the form of a second order polynomial regression (with an upward curve that increases as the difference increases).

<sup>lxxiv</sup> COM = commercial aviation, and GA = general aviation.

<sup>lxxv</sup> TO = takeoff; SL = sideline; AP = approach; and LF = level flyover.

To determine the coefficients of the second order regression, the as-measured  $PNT_{max}$  versus  $\Delta(M_{ADV\_T} - M_{ADV\_R})$  can be plotted in a spreadsheet or statistical analysis program, and the computed trendline computation will determine the regression coefficients ( $B_0$ , the constant,  $B_1$ , the first-order term, and  $B_2$ , the second-order term). A separate regression shall be computed for each microphone position: centerline, left side, and right side, and provided in Table 11-42.

It should be noted that computing these coefficients with data taken over a limited range of airspeeds may result in an adjustment that produces unrealistic results, when applied far outside of this range of airspeeds in a modeled case.

Table 11-42 Helicopter Speed Coefficients

Position	Coefficients		
	$B_0$	$B_1$	$B_2$
Center			
Left			
Right			

#### 11.2.3.3.4 Departure Procedures

Departure procedures consist of ground and flight idle segments, a combination of vertical and horizontal movement segments, and ending in a level flight segment. An idle segment is defined by its duration. A climb segment is defined by its endpoint AFE altitude (feet). An acceleration segment is defined by its calibrated airspeed at its endpoint. If data for additional takeoff weights are provided in addition to the maximum takeoff weight specified in Section 11.2.3.3.2, please provide procedural data for each takeoff weight.

The table below should be completed for each submitted procedure. The number and sequence of procedure steps given below is for example purposes only and will vary depending on the aircraft and operating procedure. In general taxi profiles, are modeled separately from departure profiles. Database submittals should comply with manufacturer's recommended departure procedures.

Repeat table for each takeoff weight provided in the data submittal.

Table 11-43 Helicopter Departure Procedures Form

Takeoff Weight (lb)			lb		
Profile Steps	Segment Type <sup>lxxvi</sup>	Duration (s)	Endpoint Altitude (AFE)	Track Distance	Endpoint Speed (KCAS)
1	Ground Idle	s			
2	Flight Idle	s			
3	Departure Vertical	s	ft		
4	Departure Horizontal Accelerate			ft	kt
5	Departure Climb Accelerate		ft	ft	kt
6	Departure Constant Speed		ft	ft	
7	Departure Horizontal Accelerate	s		ft	kt
8	Level Fly			ft	

#### 11.2.3.3.5 Approach Procedures

A landing profile should be calculated for a helicopter starting with a level flight segment, followed by a combination of vertical and horizontal movement segments (corresponding with a 6 degree approach, when appropriate) with , and ending with flight and ground idle segments. If available, profiles for additional approach angles (such as 3 degree, 9 degree, and 12 degree) should also be submitted.

Table 11-44 should be completed for each submitted procedure. The number and sequence of approach procedure steps given below is for example purposes only and will vary depending on the aircraft and operating procedure. Database submittals should comply with manufacturer's recommended approach procedures.

In general, taxi profiles are modeled separately from approach profiles. The number and sequence of taxi procedure steps given in Table 11-45 for a helicopter with wheels and in Table 11-46 for a helicopter without wheels is for example purposes only and will vary depending on the aircraft and operating procedure.

<sup>lxxvi</sup> Add, delete, and sequence the segments as necessary to represent a takeoff procedure.

Table 11-44 Helicopter Approach Procedures Form

Approach Angle				
Segment Type <sup>lxxvii</sup>	Duration (s)	Endpoint Altitude (AFE)	Track Distance (ft)	Endpoint Speed (KCAS)
Start Altitude <sup>lxxviii</sup>		ft		kt
Level Fly			ft	
Approach Horizontal Decelerate			ft	kt
Approach Constant Speed		ft	ft	
Approach Descend Accelerate		ft	ft	kt
Approach Vertical	s	ft		
Flight Idle	s	0 ft		
Ground Idle	s	0 ft		

Table 11-45 Helicopter Taxi Procedures for a Helicopter with Wheels Form

Segment Type <sup>lxxix</sup>	Duration (s)	Endpoint Altitude (ft AFE)	Track Distance (ft)	Endpoint Speed (KCAS)
Ground Idle	s	0 ft		
Flight Idle	s	0 ft		
Taxi				kt
Flight Idle	s	0 ft		
Ground Idle	s	0 ft		

<sup>lxxvii</sup> Add, delete, and sequence the segments as necessary to represent a takeoff procedure.

<sup>lxxviii</sup> Since there are no track distance and duration information associated with a “Start Altitude” segment, the endpoint speed and altitude correspond to the starting speed and altitude.

<sup>lxxix</sup> Add, delete, and sequence the segments as necessary to represent a takeoff procedure.

Table 11-46 Helicopter Taxi Procedures for a Helicopter without Wheels Form

Segment Type <sup>lxxx</sup>	Duration (s)	Endpoint Altitude (ft AFE)	Track Distance (ft)	Endpoint Speed (KCAS)
Ground Idle	s	0 ft		
Flight Idle	s	0 ft		
Departure Vertical	s	ft		
Taxi				kt
Approach Vertical	s	0 ft		
Flight Idle	s	0 ft		
Ground Idle	s	0 ft		

#### 11.2.3.3.6 NOISE DATA

For helicopters, noise-operational mode-distance data consist of a set of three noise curves for dynamic operations and a single noise curve for static operations. Noise data are required for noise exposure levels (Sound Exposure Level [SEL] and Effective Perceived Noise Level [EPNL]) and maximum noise levels (Maximum A-weighted Sound Level [LAMAX] and Maximum Tone-Corrected Perceived Noise Level [PNLTM]). Noise levels should be adjusted for spherical spreading, distance duration, time-varying aircraft speed, and atmospheric absorption in accordance with the methodology presented in SAE-AIR-1845<sup>3</sup>.

The following two tables present the noise type and operation mode used to define each noise-distance data set:

<sup>lxxx</sup> Add, delete, and sequence the segments as necessary to represent a takeoff procedure.

Table 11-47 Noise Type for Each Helicopter NPD Data Set

Noise Type	Description
L <sub>AE</sub>	Sound Exposure Level (note reference speed)
L <sub>EPN</sub>	Effective Perceived Noise Level (note reference speed)
L <sub>ASmx</sub>	Maximum A-weighted Sound Level (near reference speed)
L <sub>PNTSmx</sub>	Maximum Tone-Corrected Perceived Noise Level (near reference speed)

Table 11-48 Operation Mode for Each Helicopter NPD Data Set

Operation Mode	Procedure Step Description	
A	Approach at constant speed	
D	Depart at constant speed	
X	Level flyover at constant speed	
G	Ground idle (GIDLE)	
H	Flight idle (FIDLE)	
I	Hover in ground effect (HIGE)	
J	Hover out of ground effect (HOGE)	
V	Vertical ascent in ground effect	
W	Vertical ascent out of ground effect	
B	Approach with horizontal deceleration	
C	Approach with descending deceleration	
E	Depart with horizontal acceleration	
F	Depart with climbing acceleration	
T	Taxi at constant speed	

Where available, level flyover noise-operational mode-distance data may be provided which are representative of different reference flight speeds. Similarly, approach data may be provided which are representative of different reference flight angles (i.e., 3, 6, 9 and 12degree approaches), and departure data may be provided for different takeoff weights (in addition to maximum takeoff weight).

11.2.3.3.6.1 Minimum Required Noise Data

A minimum of nine SEL NPD curves for dynamic operations and two LAMAX curves for static operations are required to model a helicopter in AEDT. Specifically, three (left, center and right) SEL curves are required for approach, departure and level flyover operations. Additionally, one hover LAMAX curve (either HIGE or HOGE, see ‘Operation Types’ table above for definitions) and one idle LAMAX curve (either GIDLE or FIDLE) are required.

11.2.3.3.6.2 Noise Data Tables for Dynamic Operations

Noise-operational mode-distance data should be provided for each dynamic operations (departure, approach and level flight), including left, center and right curves, representative of 45 degree, 90 degree, and 45 degree elevation angles, respectively.

Repeat the following table for each combination of noise type and dynamic operation.

Table 11-49 Helicopter NPDs for Dynamic Operations Form

Noise Type		Operation		
Distance (ft)	Speed (KCAS)			
	NPD Level (dB)			
	Left	Center	Right	
200	dB	dB	dB	
400	dB	dB	dB	
630	dB	dB	dB	
1,000	dB	dB	dB	
2,000	dB	dB	dB	
4,000	dB	dB	dB	
6,300	dB	dB	dB	
10,000	dB	dB	dB	
16,000	dB	dB	dB	
25,000	dB	dB	dB	



#### 11.2.3.3.6.3 Noise Data Tables for Static Operations

A single curve should be provided for each static operation (ground idle, flight idle, hover in ground effect, and hover out of ground effect) collected directly in front of the helicopter (0 degree) at a nominal distance of approximately 200 feet. These data should be adjusted out to the 10 NPD distances for spherical spreading, distance duration, time-varying aircraft speed, and atmospheric absorption in accordance with the methodology presented in SAE-AIR-1845<sup>3</sup>. Instead of the three noise curves representing helicopter directivity in dynamic operations (see Section 11.2.3.3.6.2), directivity for static operations is represented by the single noise curve plus a directivity adjustment (see Section 11.2.3.3.8).

Repeat the following table for each combination of noise type and static operation.

Table 11-50 Helicopter NPDs for Static Operations Form

Noise Type	Operation
Distance (ft)	NPD Level (dB)
200	dB
400	dB
630	dB
1,000	dB
2,000	dB
4,000	dB
6,300	dB
10,000	dB
16,000	dB
25,000	dB

#### 11.2.3.3.6.4 NPD Adjustments

As discussed in Section 11.2.3.3.6.1, many helicopter data submittals may not consist of a comprehensive data set covering all operational modes. Therefore, the AEDT can perform noise calculations even if noise data is not available for every flight operational mode. When a flight profile uses a particular operating mode for which noise data are not available, the AEDT substitutes noise data from a similar operating mode. It also adds any dB offsets specified in the helicopter noise data set. The AEDT makes substitutions for missing NPD data sets as follows:

Table 11-51 Noise Data Substitutes for Missing Operational Modes

Missing Flight Operational Mode	Use Available Operational Mode
GndIdle	FltIdle
FltIdle	GndIdle
HovInGE	HovOutGE
HovOutGE	HovInGE
DepVertInGE	HovInGE + Vert Asc Adjustment
DepVert.OutGE	HovOutGE + Vert Asc Adjustment
AppVertInGE	HovInGE + Vert Des Adjustment
AppVert.OutGE	HovOutGE + Vert Des Adjustment
AppHorDec	Approach + Decel Hor Adjustment
AppDesDec	Approach + Decel Des Adjustment
DepHorAcc	Depart + Accel Hor Adjustment
DepClimAcc	Depart + Accel Clm Adjustment
Taxi	FltIdle (has wheels) HovInGE (no wheels)

The NPD Adjustments supplied below will only be applied to the corresponding helicopter NPD data. These NPD adjustments are typically manufacturer supplied, fixed noise level adjustments for operational modes that are not directly represented in the AEDT NPD database. Historically, these adjustments are based on empirical data, and it is up to the data supplier's discretion on how to develop these adjustments. These adjustments are always superseded by operation-specific helicopter NPDs, when available. If adjustments are not provided, then default values of 0.0 dB are used.

Table 11-52 NPD Adjustments for Helicopter Operations Form

Type of Operation	NPD Adjustment	NPD Adjustment Level (dB)
Departure Vertical (In Ground Effect and Out of Ground Effect)	Vert Asc Adjustment	dB
Approach Vertical (In Ground Effect and Out of Ground Effect)	Vert Des Adjustment	dB
Approach Horizontal Decelerate	Decel Hor Adjustment	dB
Approach Descend Decelerate	Decel Des Adjustment	dB
Departure Horizontal Accelerate	Accel Hor Adjustment	dB

#### 11.2.3.3.7 Spectral Data

In addition to NPD data, unweighted one-third octave-band spectral data corresponding to the time of  $L_{PNTS_{mx}}$  and the time of  $L_{AS_{mx}}$  should be provided for each thrust level represented in the NPDs, including data corresponding to left, center and right NPD curves for dynamic operations. At a minimum, six tables

of unweighted one-third octave-band spectral data collected at the center microphone are requested that correspond to the following NPDs:

- maximum A-weighted sound level for approach,
- maximum A-weighted sound level for departure,
- maximum A-weighted sound level for level flight,
- maximum tone-corrected perceived noise level for approach,
- maximum tone-corrected perceived noise level for departure, and
- maximum tone-corrected perceived noise level for level flight.

The spectra should be for the same operational conditions provided in the noise exposure and maximum noise tables, and span the one-third octave-bands from 20 to 10,000 Hz<sup>lxxxii</sup>. The spectra should be measured at a speed close to the indicated reference speed and adjusted to a reference distance of 1,000 feet using the atmospheric absorption table<sup>3</sup>. Repeat table for each combination of noise type and operation.

Table 11-53 Helicopter Spectral Data for Spectral Class Determination Form

Noise Type <sup>lxxxii</sup>	Operation <sup>lxxxiii</sup>
<b>Reference Speed (KCAS)</b>	<b>kt</b>
<b>One-Third Octave-Band Nominal Center Frequency (Hz)</b>	<b>One-Third Octave-Band Level (dB)</b>
20	dB
25	dB
31.5	dB
40	dB
50	dB
63	dB
80	dB
100	dB
125	dB
160	dB
200	dB
250	dB
315	dB
400	dB

<sup>lxxxii</sup> Note: if one-third octave-band spectral data are available at frequencies below 50 Hz (e.g., 20 Hz to 50 Hz), they should also be submitted.

<sup>lxxxii</sup> Noise type represents the third-octave band spectra at time of max ( $L_{ASmx}$  and  $L_{PNTSMx}$ ).

<sup>lxxxiii</sup> Operations are abbreviated as follows: A = Approach, D = Depart and L = Level Flight

Noise Type <sup>lxxxii</sup>	Operation <sup>lxxxiii</sup>
<b>Reference Speed (KCAS)</b>	<b>kt</b>
<b>One-Third Octave-Band Nominal Center Frequency (Hz)</b>	<b>One-Third Octave-Band Level (dB)</b>
500	dB
630	dB
800	dB
1,000	dB
1,250	dB
1,600	dB
2,000	dB
2,500	dB
3,150	dB
4,000	dB
5,000	dB
6,300	dB
8,000	dB
10,000	dB

#### 11.2.3.3.8 Directivity Data for Static Operations

Directivity data for static operations (HIGE, HOGE, GIDLE and FIDLE) shall be collected for modeling purposes, providing relative differences in sound level as a function of angle around the craft. Data for these operations shall be collected at locations representative of multiple directivity angles around the helicopter. Microphones should be placed around the helicopter at a nominal radial distance of approximately 200 feet. AEDT accommodates data in 15 degree increments, but will linearly interpolated to fill in missing data. At a minimum data should be collected at 45 degree increments around the helicopter.

Relative directivity adjustment data should be provided for static operations. If possible, directivity adjustments should be supplied for both hard ground (e.g., pavement) and soft ground (e.g., grass).

Table 11-54 Helicopter Directivity Adjustment Data Form

Helicopter Directivity Angle (deg)	Adjustment (dB)	
	Hard Ground	Soft Ground
180 (L)	dB	dB
165 (L)	dB	dB
150 (L)	dB	dB
135 (L)	dB	dB
120 (L)	dB	dB
105 (L)	dB	dB
90 (L)	dB	dB
75 (L)	dB	dB
60 (L)	dB	dB
45 (L)	dB	dB
30 (L)	dB	dB
15 (L)	dB	dB
0	dB	dB
15 (R)	dB	dB
30 (R)	dB	dB
45 (R)	dB	dB
60 (R)	dB	dB
75 (R)	dB	dB
90 (R)	dB	dB
105 (R)	dB	dB
120 (R)	dB	dB
135 (R)	dB	dB
150 (R)	dB	dB
165 (R)	dB	dB
180 (R) = 180 (L)	dB	dB

### 11.3 Aircraft Noise and Performance Data Verification and Validation

This section describes the Validation and Verification (V&V) processes for new aircraft noise and performance database submittals for inclusion in AEDT. Typically, the aircraft manufacturer or consultants to the manufacturer provide new database submittals. Because of the many different measurement and processing methodologies that could be employed by these parties, the quality of new submittals must always be inspected for consistency and completeness in the AEDT Fleet database to ensure high data quality. This inspection process is referred to as validation and verification. As far as updated or revised database submittals are concerned, the scope of the inspection process is specifically

tailored to each submittal, based on the nature and extent of the update or revision. For in-depth updates, the full V&V process is conducted.

The format and content of a new database submittal are laid out in the AEDT Database Request Form. To request the AEDT Database Request Form, contact [aedt-support@dot.gov](mailto:aedt-support@dot.gov). All database submittals should be checked against the requirements in this form for completeness. All required data must be present in order to run the submitted aircraft in AEDT.

New database submittals are comprised of both noise and performance data; however, these two data sets may be evaluated independently. The noise portion of this database is divided into two major parts: the NPD data and the spectral data. Both of these data sets undergo the V&V process to insure the quality of the data. Once the quality of the data submittals has been checked, the spectral data are further processed and spectral class assignments are made.

The performance portion of this database (which also includes aircraft and engine data) also undergoes the V&V process to insure data quality. Performance data are checked for consistency with existing data and reasonableness. This includes a sensitivity analysis to determine impacts due to the new data.

After the noise and performance data have been reviewed, the entire aircraft noise and performance data set is incorporated into AEDT, and a comparison with noise certification data is conducted as a final check.

### 11.3.1 NPD and Spectral Data Verification and Validation

The new acoustic data for an aircraft consist of a set (or sets) of NPD data corresponding one-third octave-band data. Typically this data would be derived from aircraft certification and would consist at Effective Perceived Noise Level ( $L_{EPN}$ ), Sound Exposure Level ( $L_{AE}$ ), Maximum A-Weighted Sound Level ( $L_{ASmx}$ ), and Maximum Tone-Corrected Perceived Noise Level (PNLT<sub>max</sub> or  $L_{PNLTsmx}$ ) NPD curves, representing each operation mode and thrust parameter values that span the range of thrust values used in the flight profiles for the aircraft<sup>lxxxiv</sup>. The corresponding one-third octave-band data are measured at the time of the maximum A-weighted sound level, or the maximum tone-corrected perceived noise level. This data are described in SAE-AIR-1845 Appendix B<sup>3</sup>. The data submitted by the manufacturer do not include recommended spectral class assignments, only spectral data corrected to 1,000 ft assuming the SAE-AIR-1845<sup>3</sup> standard atmosphere<sup>lxxxv</sup>.

The Verification and Validation of NPD and spectral data involves four major tasks:

- Internal consistency check
- Comparison of new NPDs to NPDs of similar aircraft
- Reprocessing of the new spectral data to produce NPDs, and the comparison of these NPDs with the new NPDs submitted by the manufacturer
- Comparison of modeled results at certification distances to the corresponding manufacturer data (either certification or NPD data)

---

<sup>lxxxiv</sup> The submittal should differentiate between acoustic data for different operational modes (approach, departure, etc.).

<sup>lxxxv</sup> Although previous submittals specified corrections using 25°C / 70% relative humidity or standard day sea level conditions of 15°C and 70% relative humidity, the use of these conditions is discouraged.

### 11.3.1.1 *Internal Consistency*

New aircraft acoustic data are checked for consistency across data files. The data must meet the AEDT's requirements for completeness, consistency and must not contradict itself. For example, the aircraft NPDs must include sound pressure levels at all 10 NPD distances. The aircraft manufacturer is then contacted if significant anomalies or data gaps are observed.

### 11.3.1.2 *Comparison with NPDs of Similar Aircraft*

The new NPD data are compared with NPDs from similar aircraft. Aircraft are deemed to be similar based on airframe model, engine type, number of engines, static thrust, engine bypass ratio, maximum takeoff, and landing weights. The NPDs are compared for each aircraft across all thrust values, in order to evaluate the overall shape of the NPDs. Approach and departure NPDs are evaluated separately. Although NPDs from different aircraft should not necessarily be the same, the comparison aids in the identification of erroneous data points and atypical data trends. The aircraft manufacturer is then contacted if significant anomalies are observed.

### 11.3.1.3 *Reprocessing NPDs and Comparison with Manufacture Submitted NPDs*

The spectral data provided by the manufacturer are reprocessed using the simplified correction method from SAE-AIR-1845<sup>3</sup> and ICAO Annex 16 – Environmental Protection, Volume I - Aircraft Noise<sup>65, lxxxvi</sup>. The process takes spectral data, sound pressure level, reference environmental conditions and aircraft speed and slant distance as inputs, and generates NPDs. This process is used to generate a NPD database for use in sensitivity tests of each new aircraft.

The resulting NPD database is then compared to the corresponding new NPD database submitted by the manufacturer. If both sets of NPDs were generated with the simplified method, then they should yield very similar results, barring any problems or errors in the NPD generation process. If the manufacturer utilized the integrated method for generating the new NPDs, differences between the sets of NPD curves are expected.

Typically, these differences may be around 0 to 1 dB at shorter distances (less than 4,000ft) and around 3 to 5 dB at 16,000 to 25,000 ft. In general, larger differences may be expected for  $L_{PNLTsmx}$  and  $L_{EPN}$  NPDs, because the integrated method deals with tone corrections on a record-by-record basis, as opposed to the simplified method, which applies them at the time of maximum sound level. The aircraft manufacturer is contacted if large differences are observed.

## 11.3.2 *Spectral Class Assignments*

The data submitted by the manufacturer do not include a recommended spectral class (SC) assignment, only the corrected spectral data. These spectral data consist of, at a minimum, two sets of unweighted, one-third octave-band sound levels measured at the time of maximum sound level (typically either  $L_{ASmx}$  or  $L_{PNLTsmx}$ ) and corrected to a reference distance of 1,000 ft, representing thrust parameter values typical of departure and approach conditions. From these sets of data, a spectral class is assigned for each condition. When a submittal contains additional data which are representative of a range of thrust

---

<sup>lxxxvi</sup> Two methods of NPD generation are presented in ICAO Annex 16; simplified and integrated. The simplified method consists of correcting the maximum sound pressure level of an event for the test day slant distance, aircraft speed and meteorological conditions to the desired reference day conditions. The integrated method incorporates these corrections for each point on the time history of the event (0.5 second intervals) and corrects for background noise, yielding a corrected spectral time history from which NPDs are derived.

parameter values, spectral class assignments are based on the maximum departure and minimum approach thrust values.

There are three acoustic propagation phenomena in AEDT which are spectrally dependent: Atmospheric absorption, excess ground attenuation, and shielding caused by barriers or terrain. As a result, spectral class assignments are based on the both the 'shape' of the spectral data and the behavior of these three effects. The assignment process has five major parts:

1. Normalization and computation of free-field effect.
2. Comparison of aircraft (AC) spectral shape to SC spectral shapes.
3. Comparison of atmospheric absorption effects calculated using AC spectra and SC spectra.
4. Comparison of ground effects calculated using AC spectra and SC spectra.
5. Comparison of barrier effects calculated using AC spectra and SC spectra.

These five processes are described in further detail below.

### 11.3.2.1 Normalization and Computation of Free-Field Effect

The submitted spectral data are normalized to 70 dB at 1,000 Hz. This allows for a visual shape comparison shown in Figure 11-13 and a computed comparison as detailed in Section 11.3.2.2.



Figure 11-13 Shape Comparison of Spectral Data

The submitted spectral data should be representative of free-field conditions. In most cases, however, the data were measured for certification purposes, and an adjustment is necessary to correct the data, which are typically measured by a 4 ft microphone over acoustically soft ground, to free-field conditions.



This adjustment is derived by computing the theoretical ground effect (detailed in Section 11.3.2.4) as a function of the emission angle (B) for source-to-receiver geometries using the 10 NPD slant distances, emission angles of 30, 40, 50, 60, 70 and 80 s, and an effective flow resistivity equal to 150 cgs rays. The resulting 60 data points are summed and retained as the free-field adjustment.

#### **11.3.2.2 Comparison of Spectral Shape**

The normalized AC spectra are compared to all of the potential applicable SC spectral shapes (i.e., approach or departure, jet or helicopter). This comparison is accomplished by subtracting the AC SPLs in each one-third octave band from the SC SPLs in the corresponding one-third octave band. The absolute values of the individual SPL differences are summed. The resulting sums are compared and the spectral class that provides the lowest sum is retained as a possibility for the final assignment. In addition, any individual differences greater than +-3 dBA (for the best-possible spectral class) are flagged. These flagged differences are examined and the possibility of the creation of a new spectral class is considered, as discussed in Section 11.2.2.

#### **11.3.2.3 Comparison of Atmospheric Absorption Effects**

The normalized AC spectra are used to compute the atmospheric absorption effect at the 10 NPD slant distances under 6 different temperature/humidity conditions using SAE-ARP-866A<sup>2</sup>: the SAE standard atmosphere, the Annex 16<sup>65</sup> reference day (59°F /70%), and the four extremes of the Annex 16 allowable test window (86°F /35%, 86°F /85%, 50°F/55%, and 50°F /85%). These 60 points make up an atmospheric absorption profile. The individual point differences between the atmospheric absorption profile for the submitted AC and the atmospheric absorption profile for all of the SC's under consideration are summed. The resulting sums are compared and the spectral class that provides the lowest sum is retained as a possibility for the final assignment.

#### **11.3.2.4 Comparison of Ground Effects Calculated using AC Spectra and SC Spectra**

The normalized AC spectra are used to compute the A-weighted, excess ground attenuation effect at the 10 NPD slant distances for 12 emission angles (0.5, 1, 2, 3, 4, 5, 6, 7, 8, 9, 10, and 20 degrees). The theoretical ground effect calculation is an implementation of the model documented by Tony Embleton, Joe Piercy and Giles Daigle (the EPD Model) of the National Research Council (NRC) in Canada<sup>71</sup>. These 120 points make up a ground effect profile. The individual point differences between the ground effect profile for the submitted AC and the ground effect profile for all of the SC's under consideration are summed. The resulting sums are compared and the spectral class that provides the lowest sum is retained as a possibility for the final assignment.

#### **11.3.2.5 Comparison of Barrier Effects Calculated using AC Spectra and SC Spectra**

The normalized AC spectra are used to compute the A-weighted barrier effect (insertion loss) at the 10 NPD slant distances for 7 path-length differences (-4, 0, 4, 8, 12, 20, and 100 ft). The barrier effect calculation is documented in Section 4.3.6. These 70 points make up a barrier effect profile. The individual point differences between the barrier effect profile for the submitted AC and the barrier effect profile for all of the SC's under consideration are summed. The resulting sums are compared and the spectral class that provides the lowest sum is retained as a possibility for the final assignment.

#### **11.3.2.6 Final Assignment of Spectral Class**

Ideally, the spectral class possibilities resulting from Sections 11.3.2.2 through 0 are identical and a final assignment can be made without further analysis. If the possibilities do not agree, the reasons for disagreement are examined and either 1) a spectral class assignment is made based on a 'majority rule', or, if no clear majority exists, 2) the possibility of the creation of a new spectral class is considered.

### 11.3.3 Performance Data Verification and Validation

The new performance data for an aircraft consist of aircraft and engine data, default flight profiles with corresponding aircraft weights, and aerodynamic and engine coefficients. These data are described in SAE-AIR-1845 Appendix A<sup>3</sup>.

The Verification and Validation of performance data involves four major tasks:

1. Internal consistency check;
2. Consistency check with prior submittals;
3. Reasonableness check; and
4. Suitability across different atmospheric conditions.

These four tasks are described in further detail below.

#### 11.3.3.1 Internal Consistency

New aircraft performance data are checked for consistency across data files. The data must meet the AEDT's requirements for completeness, consistency and must not contradict itself. For example the aircraft weight for the highest stage-length profile must be lower than the aircraft's maximum gross takeoff weight in order to successfully run through AEDT.

#### 11.3.3.2 Consistency with Prior Submittals

The new performance data are compared with earlier submittals from the same source for consistency in content, naming conventions, etc. Comments are made to improve overall database consistency as appropriate. Although performance data from different aircraft should not necessarily be the same, the comparison aids in the identification of erroneous data points and atypical data formats. The aircraft manufacturer is then contacted if significant differences are observed.

#### 11.3.3.3 Reasonableness

New performance data are checked for reasonableness by comparing to data from other similar aircraft types. Aircraft are deemed to be similar based on airframe model, engine (type and number of engines), static thrust, as well as maximum takeoff and landing weights. Any large deviation for a given field compared to other similar aircraft will be noted and questioned. Although performance data from different aircraft should not necessarily be the same, the comparison aids in the identification of erroneous data points and atypical data trends. In addition, single-event SEL contours are run to ensure that the data produces reasonable output in terms of contour size and shape. The aircraft manufacturer is then contacted if significant anomalies are observed.

#### 11.3.3.4 Suitability for Varying Atmospheric Conditions

New performance data are checked to ensure they are suitable for use across the typical range of atmospheric conditions (airport elevation, temperature, etc.) encountered when modeling noise around an airport. For procedural profile data, the resultant altitude, speed, and thrust values vs. track distance are examined for a range of input atmospheric conditions to ensure that the profiles produce reasonable results. For example a defined procedural profile must be flyable from a sea-level airport on a 59°F day as well as from an airport at 5,000 ft MSL on a 90°F day.

Performance coefficients are derived from a wide range of manufacturer generated flight profiles, reflecting different operating weights, procedures and atmospheric conditions. As a final cross check,

the flight profiles are re-generated using the performance coefficients and compared with the original manufacturer-generated flight profiles.

#### **11.3.4 Model Comparison of Submitted Data with Certification Data**

Once the spectral class assignment and the performance data V&V process are completed, all of the new aircraft data (including the new NPDs) are entered into the AEDT Fleet database (as either a User Defined aircraft or as updated database files). AEDT is run to mimic a noise certification flight test with receivers at the certification distances for both approach and departure tracks. The AEDT results at the certification locations are checked against the corresponding data submitted to the sponsoring organization by the manufacturer (either certification or NPD data). This acts as a final check of both the noise and performance data. The aircraft manufacturer is contacted if large differences are observed.

Additionally, new or updated data may be run through a sensitivity analysis to determine single-event or airport-wide noise impacts from the new data, as necessary. The level of detail and level of effort involved for a given sensitivity analysis may vary depending on the purpose of the supplemental analysis. When there are significant changes in data for single-event or airport-wide noise contours, the aircraft manufacturer is contacted, and the new data are further analyzed.

---

## 12. Appendix – BADA 4 Model

### 12.1 Introduction

#### 12.1.1 History of BADA 3

EUROCONTROL developed the Base of Aircraft Data (BADA) in the 1990s, with a first release of BADA 2.1 in 1994. EUROCONTROL intended BADA to be a consistent set of data and methods that Air Traffic Management (ATM) providers could use to predict the performance of aircraft. To correctly model aircraft performance over the time and distance scales of interest to ATM providers, BADA includes a fuel consumption model. This fuel consumption model was of particular interest to the FAA; the fuel consumption model of BADA was added to a number of FAA tools, including the FAA's Emissions and Dispersion Modeling System (EDMS) – a predecessor of AEDT, through an agreement between EUROCONTROL and the FAA. When the AEDT model was developed, the use of the (then current) BADA family 3 (BADA 3) was added to AEDT, with the en-route performance data of BADA 3 added to the existing AEDT Doc 9911 terminal area performance models.

#### 12.1.2 Why BADA 4 Is Necessary

EUROCONTROL designed BADA 3 to work well in the nominal cruise region for the various modeled aircraft with relatively simple models of the physics of aircraft motion. EUROCONTROL did not intend BADA 3 to optimally model aircraft operations in the terminal area and in en-route climbs and descents, which are the regions of most environmental concerns. While BADA 4, like BADA 3, is intended primarily as an ATM model and is not explicitly an environmental model, BADA 4 addresses the BADA 3 gaps by containing both higher fidelity data for existing flight regions and new data and methods for operations in the terminal and en-route regions. These expansions of the data allow BADA 4 to be used for all flight regions. Note that BADA 4 does not contain data and methods for modeling aircraft operations on the ground, so AEDT uses Doc 9911 methods for the takeoff and landing ground rolls.

#### 12.1.3 BADA 4 Data Restrictions

BADA 4 methods, data, and documentation are proprietary to EUROCONTROL. EUROCONTROL protects this data at the behest of the aircraft manufacturers, who have an interest in restricting the exposure of the high fidelity aircraft performance data contained in BADA 4. For that reason, the discussion of the BADA 4 data below does not contain specific details.

### 12.2 FAA's Interest in BADA 4

The FAA has an interest in populating AEDT with the best available data and methods. For aircraft performance and fuel consumption, the best currently available model is BADA 4. EUROCONTROL and FAA have established a licensing agreement that lets AEDT users make use of the BADA 4 data, but the BADA 4 data themselves are encrypted in the AEDT database.

#### 12.2.1 ANP Limitations for Environmental Modeling

The Aircraft Noise and Performance (ANP) database<sup>13</sup>, which is also maintained by EUROCONTROL, and that is used in prior and current versions of AEDT has some limitations when used for the purpose of

environmental modeling. Three performance modeling areas that are improved through the use of BADA 4 instead of Doc 9911 are: 1) speed-independent drag models, 2) sea-level biased performance, and 3) hard-wired constants. These are discussed below.

#### **12.2.1.1 *Speed-independent Drag Models***

Doc 9911 uses a single coefficient for the ratio of the drag divided by the lift for a given aircraft configuration. This ratio (the 'R' coefficient) is independent of the aircraft speed in the Doc 9911 model. In reality, for a given aircraft configuration, the drag and the lift vary as a function of the aircraft's angle of attack (AOA), and that AOA is itself a function of the lift required to support the aircraft. That required lift is a function of the weight and speed of the aircraft. Representing this interrelationship with a single number is a compromise – part of that compromise was the computing power available in 1986 when the Doc 9911 methods were developed. Today, however, computing power is no longer a restriction on calculating aircraft performance.

#### **12.2.1.2 *Terminal Area Performance Tuned to Sea Level, ISA***

The original Doc 9911 methods found in SAE-AIR-1845<sup>3</sup> do not specifically list an altitude and temperature range over which the data and methods are considered valid. Modifications have been made to the Doc 9911 methods over the years to extend their useful range. These additions include the quadratic term on the altitude effects on engine performance, and the addition of separate performance equations for operations above the break-point temperature of the engine. These methods extend the useful range of the ANP data, but those data are still intended to function best at sea level, ISA conditions. In addition, the ANP data assumes aircraft restrict their climb-out speeds to 250 KCAS below 10,000 feet AFE, when in reality the speed restriction is based on altitude MSL.

#### **12.2.1.3 *Hard-wired Constants***

Doc 9911 contains a number of hard-wired constants which assume the aircraft is climbing into an 8 knot headwind at a reference speed of 160 KCAS. This assumption is also included in the speed-dependent climb constant given in SAE-AIR-1845<sup>3</sup> (equation A-8). These constants are primarily used in Doc 9911 to support the ground reference viewpoint and to simplify the modeling of the acceleration inherent in climbing at a constant calibrated airspeed. In the BADA 4 air-mass reference, and with BADA 4's full physical model, these hard-wired constants and simplifications are no longer needed.

#### **12.2.2 *Speed- and Configuration-Dependent Noise***

In addition to the Doc 9911 limitations discussed above, we note that one of the gaps in the current version of AEDT is the inability to separate the effects of airframe noise from propulsion system noise. Future versions of AEDT will likely need to account for airframe noise as a function of aircraft configuration and airspeed. This type of airframe noise modeling will require an aerodynamic model that represents the drag of the aircraft with more fidelity than the Doc 9911 speed-independent methods. While BADA 4 has not yet been demonstrated to have adequate fidelity to model airframe noise, the BADA 4 speed-, configuration-, and weight-based drag should provide the required foundation for airframe noise methods.

## 12.3 BADA 4 Overview

### 12.3.1 Total Energy Model Overview

The BADA 4 total energy model (TEM) is the same as the BADA 3 TEM. That is, the total energy models are the same, but the determination of the underlying aircraft parameters – the thrust and drag for the given aircraft state – are unique to the particular BADA family. Note that fuel consumption isn't included in the TEM, but is important for determining the aircraft mass, which is part of the TEM.

### 12.3.2 BADA 4 Components

BADA 4 thrust, fuel consumption, and drag models exist for turbofan, turboprop, and piston engine aircraft – the forms of the models are tailored for each aircraft type. Below are general discussions of each of these component models. As mentioned above, the component models are not presented in the form used by AEDT as these models are proprietary to EUROCONTROL.

#### 12.3.2.1 Thrust Model

The BADA 4 database generally contains thrust modeling data for similar idle and non-idle ratings as ANP for turbofan aircraft. For non-idle ratings, these ratings are generally the maximum takeoff power rating, and the maximum climb power rating. Unlike ANP, BADA 4 also includes data for a cruise power thrust rating. Not all BADA 4 ratings are available for all aircraft. In AEDT usage, if BADA 4 data for a particular rating is not available for a given aircraft, thrust at that rating is modeled according to Doc 9911 instead. So, for example, aircraft which do not have maximum takeoff thrust data in BADA 4, would use the ANP maximum takeoff thrust data.

Turbofan thrust models are also split into temperature independent and temperature-dependent regions. This usage is similar to the Doc 9911 usage of high temperature thrust curves. Like the Doc 9911 model, at temperatures above ISA conditions, AEDT uses the lower of the thrust calculated by the BADA 4 temperature independent and temperature dependent methods. Note that this is slightly different from the BADA 4 criteria of using the difference between the local temperature and the local ISA temperature to determine which engine thrust temperature region to use.

Engine performance for a given rating is modeled as a high order polynomial. This polynomial is a function of the local atmospheric conditions, aircraft Mach number, and the set of polynomial coefficients unique to the aircraft and its operating mode.

#### 12.3.2.2 Fuel Consumption Model

The BADA 4 fuel consumption model has a parallel structure to the BADA 4 thrust model; for every thrust rating model, there is a corresponding fuel consumption model. As with the thrust models, the fuel models are split by idle and non-idle ratings. The non-idle ratings are takeoff, climb, and cruise.

Unlike the thrust models, the fuel models don't split into temperature regions; the same fuel consumption methods are used at all temperatures.

The BADA 4 fuel consumption generally depend on the thrust (or power) generated by the engine (which is a function of the parameters discussed above), and the Mach number of the aircraft. Idle fuel consumption is also directly dependent on local atmospheric conditions.

#### **12.3.2.3 Drag Model**

BADA 4 uses separate models for clean and deployed high-lift devices (non-clean). Both clean and non-clean models make use of the lift coefficient found using the assumption of zero flight path angle and the instantaneous bank angle of the aircraft.

The clean drag model is a function of high-order polynomials which are generally a function of Mach number. The coefficients of the polynomial equations are unique to each aircraft.

The non-clean drag model uses a lower ordered polynomial. The coefficients of the polynomial equations are unique to each aircraft and to the particular high-lift configuration of that aircraft. So each aircraft has a single set of clean drag model coefficients, but as many sets of non-clean drag models as there are non-clean configurations. Note that BADA 4 contains both a simple speed brake deployment model and a flap transition model, but these have not yet been adopted in AEDT.

## 13. Appendix – Emissions Dispersion

### 13.1 Constructing AERMOD Rectangle Sources from a Line Segment

To comply with AERMOD modeling best practices, some AEDT sources must be subdivided into smaller sub-segments while generating AERMOD rectangular “AREA” sources (e.g., taxi segments). This is achieved using the three-dimensional Cartesian coordinates for both ends of the line segment, its width, and the maximum desirable sub-segment length. AEDT applies the following algorithm:

1. Determine the line segment’s transverse distance,  $L$ , and width,  $w$ .
2. Define the maximum desirable sub-segment length to equal  $10w$ .
3. Determine the number of sub-segments,  $n$ , by dividing the length by the maximum desirable sub-segment length and rounding the quotient up to the nearest integer.
4. For each integer  $i$ , from 1 to  $n$ , construct an AREA source as follows:
  - 4.1. Determine the position of point  $p_i$  which is  $(i - 1)/n^{th}$  along the line segment.
  - 4.2. Offset  $p_i$  to left perpendicular to the segment by half the width of the line segment.  $p_i$  is now the “position” of the AREA source.
  - 4.3. Determine the elevation of source  $i$  to be the average elevation of its endpoints,  $z = z_1 + (z_2 - z_1) \left( \frac{i-0.5}{n} \right)$ , where  $z_1$  is the elevation of the first point the line segment and  $z_2$  is the elevation of the last point of the line segment.
5. Set the orientation angle of all of the AREA sources equal to  $\text{atan2}(x_2 - x_1, y_2 - y_1)$  where “atan2” is the standard two-argument arctangent function (in degrees).
6. Set the length of all of the AREA sources equal to  $L/n$ .

This algorithm (identical to the one in EDMS) serves two main purposes. First, it defines how a flight’s ground roll and taxi line segments are converted into area sources. Second, it defines an algorithm of splitting the flight’s ground line segments into a set of area sources. In addition, in case of the airborne line segments (airborne sources), the item #5 of the algorithm is used to determine the orientation of the area sources. Default X/Y spacing for airborne source is 200 m (this can be changed in the Study Preferences screen), which in turn defines the spacing of the respective voxel grid. For all types of the area sources, the orientation in item #5 is relative to a standard latitude/longitude based Cartesian coordinate system typically used in AERMOD.

The most exact illustration of the algorithm is a representation of the flight’s taxi line segments as area sources. In this case,  $L$  is the distance between taxi network link nodes, taxi area source width  $w=20$  m, and maximum allowed length of a taxi area source is  $10*w = 200$  m. Each taxi link is split if needed into smaller sub-segments not longer than 200 m. For example, a taxi link with  $L = 190$  m will not be split and will be represented as one area source. A taxi link with  $L = 300$  m will be represented as two area sources with the length of 150 m each.



## 13.2 Emissions Factor Calculation for Stationary Sources and Training Fires

This section describes the process AEDT performs to calculate the emissions for stationary sources and training fires.

### 13.2.1 Data Sources

Calculating the emissions for stationary sources (Section 5.3) requires user-supplied annual throughput/consumption and model-generated pollutant emission factors. For some stationary sources, users may adjust emission indices directly on the user interface; for others, (e.g., fuel tanks, particulate piles), the emission factors are calculated by AEDT based on user-supplied data. Air pollution emission factors, and related emission calculation input data, and emission calculation procedures for emission stationary point and area sources are available in Volume I of the Fifth edition of U.S. EPA Report No. AP-42: Compilation of Emission Factors.<sup>72</sup> Additional details related to aircraft engine testing are available in U.S. EPA's *Procedures for Emission Inventory Preparation*, Volume IV;<sup>73</sup> additional details related to surface coatings are available in *Calculation Methods for Criteria Air Pollutant Emission Inventories*<sup>74</sup>.

For NMHC, VOC, TOG and PM<sub>2.5</sub>, the conversion factor (referred to as  $fp,s$  in equations below) for a stationary source is calculated based on the appropriate speciation profile mass fractions stored in the STN\_MASSFRAC table.

THC emissions for stationary sources and training fires (except aircraft engine testing) are not reported by AEDT. They are used only to estimate the NMHC, VOC and TOG emissions.

The following sections describe how AEDT implements the methodologies for computing the emission factors required by Eq. 5-30.

### 13.2.2 Other Category

Eq. 13-1 is the generic equation used to compute emission factors for other category stationary sources from a raw emission factor and pollution control factor. All variables on the right hand side can be user-specified. The parameters used for VOC, TOG and NMHC are equal to those used for THC, and the parameters for PM<sub>2.5</sub> are the same as those used for PM<sub>10</sub>. The THC emissions for stationary sources and training fires are not reported by AEDT. They are used only to estimate the NMHC, VOC and TOG emissions.

Eq. 13-1. Other Category Stationary Source Emission Factors

$$EF_{p,s} = EF_{raw,p,s} \left(1 - \frac{PCF_{p,s}}{100}\right) \quad \text{Eq. 13-1}$$

where

$EF_{p,s}$  The emission factor (units are user-specified) for pollutant,  $p$ , for source,  $s$ ;  
 $EF_{raw-cont,p,s}$  The raw or controlled emission factor (same units as  $EF_{p,s}$ ) for pollutant,  $p$ , and source,  $s$ ; and

$PCF_{p,s}$  The pollution control factor (%) for pollutant,  $p$ , and source,  $s$ ; if the emission factor on the right-hand side of the equation is controlled, the  $PCF$  equals zero.

### 13.2.3 Boilers and Space Heaters

Emission factors for boilers and space heaters in AEDT are calculated based on methodology in U.S. EPA's AP-42: Compilation of Emission Factors, Chapter 1. The source of methodology and default data for each fuel type is shown in Table 13-1.

Table 13-1 Methodology and Data Sources for Boilers/Heaters

Boiler and Heater Fuel Type	Methodology/Data Source	Last Update
Bituminous and Subbituminous Coal	AP-42 Ch. 1.1	September 1998
Anthracite Coal	AP-42 Ch. 1.2	October 1996
Fuel Oil	AP-42 Ch. 1.3	September 1999
Natural Gas	AP-42 Ch. 1.4	July 1998
Liquefied Petroleum Gas	AP-42 Ch. 1.5	July 2008

Table 13-2 specifies which input parameters are applicable to each boiler/heater type, based on the availability of default data in EPA's AP-42. Typical control efficiencies for boilers and heaters are provided by target pollutant in Table 13-3 (EPA AP-42, Chapter 1).

Table 13-2 Required Parameter Specifications for Boilers and Space Heaters

Input Parameter	Applicability (by Type or CATEGORY_REC_ID)
CO_EI	Applicable to all except 35-37
TNMOC_EI	Applicable to all except 6, 7, 34-37, 48, 49, 64-75
NOx_EI	Applicable to all except for 37
PM10_EI	Applicable to all except 1-17, 34-36, 38-44, 57, 58
SOx_EI	Applicable to all except 37
PM10_EI_CONSTANT	Only applicable to 33, 38-44, 57, 58
VOC_EI	Only applicable to 64-73
TOC_EI	Applicable to all except 1-32, 53-56, 76, 34-37, 51, 52
THC_EI	Not applicable to any equipment
FUEL_SULFUR_CONTENT	Applicable to all except 64-73
PM10_EI_SULFUR_TERM	Only applicable to 38-44, 60, 61
PM25_TO_PM10_RATIO	Applicable to all
FUEL_ASH_CONTENT	Only applicable to 1-32, 53-56, 76, 33-37
CH4_EI	Applicable to all
CO2_EI	Applicable to all

Table 13-3 Typical Pollution Control Efficiencies for Boiler/Heater Controls

<b>SO<sub>2</sub> Pollution Control</b>		
<b>Boiler Type</b>	<b>Control Technology</b>	<b>Control Efficiency</b>
Bituminous and Sub-bituminous Coal	Wet scrubber, lime/limestone	80
Bituminous and Sub-bituminous Coal	Wet scrubber, sodium carbonate	80
Bituminous and Sub-bituminous Coal	Wet scrubber, magnesium oxide/hydroxide	80
Bituminous and Sub-bituminous Coal	Wet scrubber, dual alkali	90
Bituminous and Sub-bituminous Coal	Spray drying	70
Bituminous and Sub-bituminous Coal	Furnace injection	25
Bituminous and Sub-bituminous Coal	Duct injection	25
Fuel Oils	Scrubbing system	90
Fuel Oils	Wet regenerable FGR	90

<b>NO<sub>x</sub> Pollution Control</b>		
<b>Boiler Type</b>	<b>Control Technology</b>	<b>Control Efficiency</b>
Bituminous and Sub-bituminous Coal	OFA	20
Bituminous and Sub-bituminous Coal	LNB	35
Bituminous and Sub-bituminous Coal	LNB with OFA	40
Bituminous and Sub-bituminous Coal	Reburn	50
Bituminous and Sub-bituminous Coal	SNCR	30
Bituminous and Sub-bituminous Coal	SCR	75
Bituminous and Sub-bituminous Coal	LNB with SNCR	50
Bituminous and Sub-bituminous Coal	LNB with OFA and SCR	85
Fuel Oils	Biased burner firing	10
Fuel Oils	FGR	40
Fuel Oils	LNB	35
Fuel Oils	LNB with OFA	40
Fuel Oils	SNCR	25
Fuel Oils	SCR	75
Fuel Oils	Oil/water emulsion	36
Natural gas	LNB with FGR	60
Natural gas	LNB	40
Natural gas	SNCR	13
Natural gas	SCR	80
Liquified petroleum gas	Retrofit/LNB/FGR	50

<b>PM Pollution Control</b>		
<b>Boiler Type</b>	<b>Control Technology</b>	<b>Control Efficiency</b>
Bituminous and Sub-bituminous Coal	All PM controls	20

Anthracite	ESP	90
Anthracite	Baghouse/fabric Filter	99.8
Anthracite	Wet scrubber/venturi/cyclone	90
Fuel Oils	Cyclonic collector	85
Fuel Oils	ESP, old	40
Fuel Oils	ESP, new	90
Fuel Oils	Baghouse/Fabric Filter	99
Fuel Oils	Scrubbing system	50

Emission factors for boilers from greenhouse gases are calculated with EPA's AP-42 as a primary source with EPA's WebFIRE and Greenhouse Gas Hub used as secondary sources only when AP-42 sources are not available. For each boiler type, emission indices and pollution control factors have been added to AEDT for both CO<sub>2</sub> and CH<sub>4</sub> in the table STN\_BOILER\_HEATER. For all types of boilers and heaters, the GHG emissions factors are available to be edited by the user when adding user defined boilers.

#### 13.2.4 Emergency Generators

Emission factors for emergency generators in AEDT are calculated using EPA's AP-42: Compilation of Emission Factors (Chapter 3.3, Gasoline and Diesel Industrial Engines) and a U.S. Air Force (USAF) method. The U.S. Air Force Method is applicable to all possible generator fuels in AEDT (gasoline, diesel, jet fuel, natural gas and liquefied petroleum gas), while the AP-42 method is only applicable to diesel and gasoline engines.

A power rating is required for generator types using the EPA methodology and fuel sulfur content is required for generator types which uses the USAF methodology. The emissions factors are user-supplied or based on default values (uncontrolled) from AP-42 and USAF. Users may also enter pollution control factors.

As part of the expansion of GHG emissions within AEDT, emission factors and pollution control factors for generators using the EPA method and emission indices using the USAF method have been added to the AEDT table STN\_EMERGENCY\_GENERATOR. For each methodology, the GHG emissions values are available to be edited by the user when adding user defined generators.

#### 13.2.5 Incinerators

Eq. 13-2 is used to compute emission factors for incinerators. All variables on its right hand side can be user-specified, except the unitless conversion factor which is currently unity (1) for all pollutants. The parameters used for TOG and NMHC are equal to those used for TOC, and the parameters for PM<sub>2.5</sub> are the same as those used for PM<sub>10</sub>.

Eq. 13-2. Incinerator Emission Factors

$$EF_{p,s} = EF_{raw,p,s} f_{p,s} \left(1 - \frac{PCF_{p,s}}{100}\right) \quad \text{Eq. 13-2}$$

where

$EF_{p,s}$	The emission factor (in kilograms per metric ton) for pollutant, $p$ , for source, $s$ ;
$EF_{raw,p,s}$	The raw emission factor (in kilograms per metric ton) for pollutant, $p$ , and source, $s$ ;
$fp,s$	The conversion factor for pollutant, $p$ , and source, $s$ ;
$PCF_{p,s}$	The pollution control factor (%) for pollutant, $p$ , and source, $s$ .

As part of the expansion of GHG emissions within AEDT, CO<sub>2</sub> and CH<sub>4</sub> emission factors and pollution control factors have been added for all incinerator types to the AEDT table STN\_INCINERATOR.

### 13.2.6 Aircraft Engine Testing

In general, aircraft engine testing emission factors are computed the same way that aircraft emissions are computed. In this case, emission factors correspond to the total emissions resulting from a single test cycle of the user-specified engine. The algorithm follows.

1. Initialize the emission factors to zero.
2. If the engine is ICAO certified and the engine's thrust rating is larger than 0, then use Eq. 5-18 to compute the startup emissions (which only consist of HC, NMHC, VOC and TOG pollutants).
3. Add the startup emissions to the emission factors.
4. Retrieve the times at each of the 4 power settings (i.e., 7%, 30%, 85% and 100% power).
5. Retrieve the EngineEIData object specific to the aircraft's engines.
6. Construct an emissionsInput object by making a copy of the default emissionsInput object.
  - 6.1. Set Sulfur\_Conversion equal to the scenario's user-specified *Sulfur-to-Sulfate Conversion Rate*. And set Sulfur\_Content to the fuel sulfur content specified for the aircraft.
  - 6.2. Set humidity = (Airport humidity)/100 to convert from percent to a fraction.
  - 6.3. Set temperature = the current temperature in Kelvin.
  - 6.4. Set pressure = the current ambient pressure in Pascals.
  - 6.5. Set theta =  $\theta$  = temperature / 288.15 degrees Kelvin.
  - 6.6. Set delta =  $\delta$  = pressure / 101,325 Pascals.
  - 6.7. Set machNo = 0.
  - 6.8. If the aircraft uses a piston engine (the EngineEIData object's Flag\_Piston = 1),
    - 6.8.1. Set NMHC\_ConversionFactor =  $8.905 \times 10^{-1}$ , the NMHC conversion factor for piston engines.
    - 6.8.2. Set TOG\_ConversionFactor =  $117.371 \times 10^{-2}$ , the TOG conversion factor for piston engines.
    - 6.8.3. Set VOC\_ConversionFactor =  $83.471 \times 10^{-2}$ , the VOC conversion factor for piston engines.
    - 6.8.4. Set SpeciatedHC\_MassRatios to the SOG mass fractions for piston engines.
    - 6.8.5. Set SpeciatedHC\_Count to the number of the SOG mass fractions for piston engines.
  - 6.9. If the aircraft does not use a piston engine,
    - 6.9.1. Set NMHC\_ConversionFactor = 1.0, the NMHC conversion factor for turbine engines.
    - 6.9.2. Set TOG\_ConversionFactor =  $1,156,234.049 \times 10^{-6}$ , the TOG conversion factor for turbine engines.
    - 6.9.3. Set VOC\_ConversionFactor =  $9,947.855 \times 10^{-4}$ , the VOC conversion factor for turbine engines.
    - 6.9.4. Set SpeciatedHC\_MassRatios to the SOG mass fractions for turbine engines.
    - 6.9.5. Set SpeciatedHC\_Count to the number of the SOG mass fractions for turbine engines.
7. For each of the four power settings,

- 7.1. Set currentMode to the corresponding value.
- 7.2. Set FlagPM = 0.
- 7.3. If the aircraft is user-created and the smoke number for the current mode is 0 or “N/A” (the corresponding smoke number data member in the EngineEIData object is negative),
  - 7.3.1. Set FlagPM = 1 to use the user-specified PM emission index.
- 7.4. Set fuelFlow =  $B_m W_m \delta \theta^{-3.8}$  where  $B_m$  is the Boeing Fuel Flow Method 2 (BFFM2) installation effect coefficient for the current mode (see Table 5-1),  $W_m$  is the unadjusted fuel flow for the engine for mode,  $\delta$  is the value of delta and  $\theta$  is the value of theta.
- 7.5. Set fuelBurn = (fuelFlow)(t) where t is the corresponding time for the power setting in seconds.
- 7.6. Call the AEM.
- 7.7. Add the resulting CO, HC, NMHC, VOC, TOG, NO<sub>x</sub>, SO<sub>x</sub> and speciated organic gases emissions to the emission factors.
- 7.8. Add the resulting PM<sub>10</sub> and PM<sub>2.5</sub> emissions to the emission factors if and only if the aircraft is (a) user-created or (b) not user-created, uses ICAO-certified engines and the applicable smoke number is greater than 0.

**13.2.7 Fuel Tanks**

Fuel tanks only emit NMHC, TOG and VOC emissions; emissions of all three pollutants may be considered equivalent. Emission factors (VOC) for fuel tanks in AEDT are calculated based on methodology in U.S. EPA’s AP-42: Compilation of Emission Factors. Fuel tank emissions are covered in Chapter 7, last updated in June 2020. Default values for tank characteristics were also derived from AP-42 Chapter 7.

Different input parameters, listed in Table 13-4, are required depending on selection of tank type.

Table 13-4 Input Parameters by Tank Type

Tank Type	Applicable Input Parameters
Vertical Fixed Roof, Cone Roof	Fuel Type RVP (gasoline tanks only) Tank Diameter (m) Tank Height (m) Maximum Liquid Height (m) Average Liquid Height (m) Roof Slope Sum of Annual increases in Liquid Level (ft) (if not supplied, AEDT uses approximation based on throughput and liquid heights)
Vertical Fixed Roof, Dome Roof	Fuel Type RVP (gasoline tanks only) Tank Diameter (m) Dome Diameter (m) (if not supplied, AEDT uses approximation based on tank diameter) Tank Height (m) Maximum Liquid Height (m) Average Liquid Height (m) Sum of Annual increases in Liquid Level (ft) (if not supplied, AEDT uses approximation based on throughput and liquid heights)

Tank Type	Applicable Input Parameters
Horizontal (Fixed Roof)	Fuel Type RVP (gasoline tanks only) Tank Diameter (m) Tank Length (m) Sum of Annual increases in Liquid Level (ft) (if not supplied, AEDT uses approximation based on throughput and liquid heights)
Floating Roof, Internal	Fuel Type RVP (gasoline tanks only) Tank Diameter (m)
Floating Roof, External	Fuel Type RVP (gasoline tanks only) Tank Diameter (m) Mean Wind Speed (m/s)
Floating Roof, Domed External	Fuel Type RVP (gasoline tanks only) Tank Diameter (m)

The Reid vapor pressure, *RVP*, is user-specified and impacts the vapor molecular weight and liquid density values (AP-42 Chapter 7) used in the emission rate calculations.

Table 13-5 Fuel Tank Vapor Molecular Weight and Liquid Density

Fuel	Reid Vapor Pressure, $RVP_s$ (in PSI)	Vapor Molecular Weight ( $\text{mol}^{-1}$ )	Liquid Density, $\rho_s$ (lbs per gallon)
Jet Naphtha	N/A	80	6.4
Jet Kerosene	N/A	130	7.0
Gasoline	6	69	5.6
	7	68	
	8	68	
	9	67	
	10	66	
	11	65	
	12	64	
13	62		
Distillate Fuel Oil No. 2	N/A	130	7.1
Residual Fuel Oil No. 6	N/A	130	7.9

### 13.2.8 Surface Coating

Surface coatings only emit NMHC, TOG and VOC emissions; all three pollutants may be regarded as equivalent in this case. U.S. VOC emission factors for surface coatings and paints were derived from the U.S. Air Force calculation methods (Jagielski and Obrien, 1994).

Eq. 13-3. Surface Coating Emission Factors

$$EF_s = EF_{s,raw} \left(1 - \frac{PCF_s}{100}\right) \quad \text{Eq. 13-3}$$

where

$EF_s$	The emission factor (in kilograms per kiloliter) for source, $s$ ;
$EF_{s,raw}$	The raw emission factor (in kilograms per kiloliter) for source, $s$ ; and
$PCF_s$	The pollution control factor (%) for source, $s$ .

### 13.2.9 Deicing

Deicing fluids only emit NMHC, TOG and VOC emissions. Eq. 13-4 is used to compute the emission factors of deicing operations. All variables on its right-hand side can be user-specified. Eq. 13-4 assumes that the deicing solution only consists of pure water and a deicing chemical (e.g., ethylene glycol). The density values for chemicals were derived from the CRC Handbook of Chemistry and Physics.

Eq. 13-4. Deicing Emission Factors

$$EF_s = EI_s \left[ \left( \frac{\rho_s}{1,000} \right) \left( \frac{F_s}{100} \right) + \left( \frac{\rho_w}{1,000} \right) \left( 1 - \frac{F_s}{100} \right) \right] \quad \text{Eq. 13-4}$$

where

$EF_s$	The emission factor (in kilograms per kiloliter) for source, $s$ ;
$EI_s$	The emission index (in grams per kilogram) for source, $s$ ;
$\rho_w$	The water density (in grams per liter), $\rho_w \approx 1000$ ;
$\rho_s$	The density (in grams per liter) of the deicing chemical of source, $s$ ; and
$F_s$	The concentration (% by mass) of the deicing chemical dissolved in solution for source, $s$ .

### 13.2.10 Solvent Degreasers

Solvent degreasers only emit NMHC, TOG and VOC emissions. The density of the solvent (CRC Handbook of Chemistry and Physics) is used to compute the emission factors for solvent degreasing operations (Eq. 13-5), assuming any solvent not disposed of is released as VOC.

Eq. 13-5. Solvent Degreaser Emission Factors

$$EF_s = \rho_s \left( 1 - \frac{\%Disp_s}{100} \right) \left( 1 - \frac{PCF_s}{100} \right) \quad \text{Eq. 13-5}$$

where

$EF_s$	The emission factor (in kilograms per kiloliter) for source, $s$ ;
$\rho_s$	The density (in grams per liter) of solvent degreaser of source, $s$ ;
$\%Disp_s$	The amount (% by mass) of the solvent degreaser properly disposed of source $s$ ; and
$PCF_s$	The pollution control factor for source, $s$ .

Typical pollution control factors for different control technologies are given in Table 13-6.



Table 13-6 Typical Pollution Control Efficiencies for Solvent Degreasing Controls

Pollution Control Type	Pollution Control Efficiency (percentage)
Cover or enclosed design	20
Water cover	20
Carbon absorption	20
Refrigerated chiller	20
High freeboard	20
Reduced exhaust ventilation	30
Waste solvent reclamation	30

### 13.2.11 Particulate Piles

Piles of sand, salt, and other materials only emit PM emissions. The emissions methodology for particulate piles is based on EPA's AP-42 Compilation of Emission Factors: Chapter 13.2.4 (Aggregate Handling and Storage) and Chapter 13.2.5 (Industrial Wind Erosion). This approach allows for consideration of emissions from unloading/loading operations, as well as wind erosion of exposed piles. Default values for threshold friction velocity and surface roughness were derived from Gillette, et al. 1982<sup>lxxxvii</sup>.

Note that a threshold friction velocity (m/s) is required for wind erosion to occur. If the friction velocity (calculated from pile surface roughness and fastest mile of wind) less than the threshold velocity, the wind erosion component is equal to zero. The following input parameters listed in Table 13-7 are required for particulate piles.

Table 13-7 Input Parameters for Emissions from Particulate Piles

Emissions Type	Parameter
Loading/Unloading	Moisture Content (%)
	Mean Wind Speed (m/s)
Wind Erosion	Eroded Surface Area (m <sup>2</sup> )
	Mass Disturbed per Disturbance (metric ton)
	Fastest Mile of Wind (m/s)
	Surface Roughness (cm)
	Friction Threshold Velocity (m/s)

### 13.2.12 Training Fires

VOC, NMHC, and TOG emissions are estimated for training fires in AEDT. The emissions factors,  $EF_{p,s}$ , for training fires are stored in the STN\_TRAINING\_FIRE table. Emissions are calculated using Eq. 5-30 by multiplying the volume of fuel burned by the emission factor.

<sup>lxxxvii</sup> Gillette, D. A., Adams, J., Muhs, D., & Kihl, R. (1982). Threshold friction velocities and rupture moduli for crusted desert soils for the input of soil particles into the air. Journal of Geophysical Research: Oceans, 87(C11), 9003-9015.

As part of the expansion of GHG emissions within AEDT, CO<sub>2</sub> and CH<sub>4</sub> emission indices and pollution control factors have been added to the AEDT table STN\_TRAINING\_FIRE.

### 13.3 Plume Rise Modeling Option

AEDT uses the EPA's atmospheric dispersion modeling system, AERMOD, for airport-related pollutants. AERMOD version 23132 allows the user to model plume rise from aircraft sources as an ALPHA option. This new algorithm includes the effects of buoyancy and horizontal momentum of exhaust gases from aircraft engines. Plume rise can be modeled for airborne aircraft, on the runways during takeoff and landing, taxiing between gates and runways, and during runups. Note that plume rise for aircraft sources is not modeled for gates, as the required data to model plume rise are not available in AEDT for ground support equipment (GSE), auxiliary power units (APU), and startup emissions.

An important thing to consider when assembling your AEDT dispersion run with plume rise is that the separation of operations into multiple operation groups (cases) and the selection of the Operation Group Source Groups under Set Processing Options will cause variations within the non-Operation Group Source Groups. These variations are due to the non-linear characteristics of the plume rise algorithm. Please only select the Operation Group Source Groups if you require the emissions concentrations by Operation Group and then only use the Operation Group Source Groups from this run.

#### 13.3.1 Plume Rise Variables in the AERMOD Hourly Emissions Rate File

AEDT generates several input files for emissions dispersion modeling with AERMOD, including the Hourly Emission Rate (HRE) file for each modeled pollutant. When aircraft plume rise modeling is enabled, the AEDT output variables, listed in Table 13-8, are included in the HRE file for each aircraft source in support of plume rise computations by AERMOD.

Table 13-8 List of Engine Variables for Plume Rise Calculations

Symbol	Variable Definition	Units	Source	Default Value
$\dot{m}_f$	Fuel Burn Rate	kg/s	AEDT	N/A
$T$	Engine Thrust	N	AEDT	N/A
$v_a$	Aircraft True Airspeed	m/s	AEDT	N/A
$AF$	Air-Fuel Ratio	ND	Wayson et al., 2009	106 – Idle 83 – Approach 51 – Climb-out 45 – Takeoff
$bypr$	Engine Bypass Ratio	ND	AEDT	N/A
$RP$	Rated Power	Kilowatts	AEDT	N/A
$\theta$	Source Angle	Degrees	AEDT	N/A

An example of the modified record in the HRE file reads as follows:

Year	Month	Day	Hour	Source ID	Emission Rate (g/s or g/sm <sup>2</sup> )	Fuel Burn Rate (kg/s)	Thrust (N)	Aircraft Speed (m/s)	Air Fuel Ratio	Bypass ratio	Rated Power (Kilowatts)	Source Angle (Degree)
2012	02	01	01	CUB0001	1.1	4.56E-02	4.48E+04	50.14	83	5.5	5500	65

Figure 13-1 List of Engine Variables for Plume Rise Calculations

Aircraft sources can be modeled as either AREA sources (with emissions rate in  $g / (s \cdot m^2)$ ) or VOLUME sources (with emissions rate in  $g/s$ ) with the plume rise option enabled. Each aircraft source is derived from one or more aircraft movements, and is an aggregation of flight segments occurring at a specific hour within a specific three-dimensional volume of space. AERMOD’s three-dimensional cartesian voxel grid is designed to collect emissions from airborne and ground roll segments. Each flight segment is split into one or more sub-segments where they intersect with the cuboid surfaces – the individual “blocks” of the voxel grid.

To ensure the correct assignment of the air-fuel ratio, and to ensure more accurate assessments of other plume rise variables, additional source groups or source modes have been added to the INP file (Table 13-9).

Table 13-9 Source Group (Source Mode) Definitions

Source Group (Source Mode)	Surface or Airborne	Air-Fuel-Ratio
Taxi-In	Surface	Idle
Taxi-Out	Surface	Idle
Takeoff Ground Roll	Surface	Takeoff
Landing Ground Roll	Surface	Approach
Takeoff airborne	Airborne	Takeoff
Climb-out	Airborne	Climb-out
Airborne approach	Airborne	Approach

Inside each cuboid, sub-segments which are associated with identical engine types and identical source modes are grouped together, and the sum of the emissions contributions for a given pollutant is calculated from all the sub-segments contained in this group. Given the time, location, and dimensions of each cuboid and its calculated non-zero emissions, a corresponding AREA or VOLUME aircraft source is constructed and assigned a sequential number,  $n$ . The emissions are collected separately for each modeling hour, and the respective emission rate for a given pollutant,  $E_n$ , is calculated as detailed in Eq. 13-6, which approximates a continuous emissions source over each hour:

$$E_n = K \sum_{a=a_n}^{A_n} \sum_{s=s_n}^{S_n} w_{n,a,s} E_{a,s} \tag{Eq. 13-6}$$

where:

$$\text{unit coefficient } K = \frac{1}{3600 [\text{sec}]} \begin{cases} 1/A [m^2], & \text{AREA source,} \\ 1, & \text{VOLUME source,} \end{cases}$$

weight coefficient  $w_{n,a,s} = \frac{\Delta t_{n,a,s}}{\Delta t_{a,s}}$  is calculated assuming constant acceleration along the flight segment  $s$  of the aircraft operation  $a$  with total segment duration  $\Delta t_{a,s}$ , and sub-segment duration  $\Delta t_{n,a,s}$  inside source  $n$ ;

$\{a_n, A_n\}$  is an aircraft operation range for a source  $n$ ; variable from one source to another;  
 $\{s_n, S_n\}$  is a flight segment range for a source  $n$ ; variable from one source to another; and  
 $E_{a,s}$  is the emissions, in grams, for a chosen pollutant for flight segment  $s$  of the air operation  $n$ .

Section 6.3 of this Technical Manual contains more information on emissions allocation for airborne and ground roll aircraft sources.

Allocating emissions from the taxi flight segments does not require a voxel grid. For taxi sources, the list of the taxi network links, retrieved from the database, serves as the containers of the taxiway sources. Each taxi flight segment references a network link, and each link could be utilized by more than one aircraft operation. Section 6.4 of this Technical Manual contains more information on emissions allocation for taxi segments. In support of aircraft plume rise modeling, taxiway sources are defined by grouping together taxiway sub-segments which are associated with a particular engine type and a taxi-in or taxi-out source mode. The hourly emission rate for a given pollutant, for each source, is calculated according to Eq. 13-6.

The Air-Fuel Ratio is assigned to each aircraft source according to the source mode associated with the source, as defined in Table 13-8 and Table 13-9, and is dependent on the trajectory mode of the flight segments contributing to the source.

Unlike the emissions rate for each unique source ID, the plume rise variables of: fuel burn rate, thrust, airspeed, bypass ratio, and rated power (Table 13-8) represent a “typical” aircraft for that hour. These plume rise variables are calculated by taking the average of all the flight sub-segment values within the source during each hour, weighted by the fuel burn contributions of all sub-segments within the source:

$$C_n = \frac{\sum_{a=a_n}^{A_n} \sum_{s=s_n}^{S_n} w_{n,a,s} Fb_{a,s} C_{a,s}}{\sum_{a=a_n}^{A_n} \sum_{s=s_n}^{S_n} w_{n,a,s} Fb_{n,s}} \quad \text{Eq. 13-7}$$

where:

$C_n$  Normalized plume rise variable (e.g., aircraft true air speed, for a source  $n$ );  
 $Fb_{a,s}$  Total fuel burn for flight segment  $s$  of the aircraft operation  $n$ ;  
 $C_{a,s}$  The respective variable (e.g., aircraft true air speed) of the flight segment  $s$  of the aircraft operation  $n$ ; and  
 $w_{n,a,s}$ ,  $\{a_n, A_n\}$ , and  $\{s_n, S_n\}$  are the same parameters defined above for Eq. 13-6.

Fuel burn, fuel burn rate and thrust for each flight segment are derived from AEDT segment-level results. AEDT can generate negative thrust values under certain operational characteristics. If the thrust value for a segment has a negative value, the thrust value for that segment will be adjusted to zero before a normalized thrust is calculated for the source. The normalized thrust variable is not applicable for helicopters or fixed-wing aircraft with turboprop or piston engines. For these types of aircraft-engine combinations, the normalized thrust variable is set to -999999.

Bypass ratio and rated output values are derived by normalizing the engine variables of the aircraft operations associated with a source. Bypass ratio is available for turbofan and turbojet engine models in the AEDT Fleet database, with turbojet aircraft having their bypass ratio set to zero. The bypass ratio is used to calculate the buoyancy parameter for turbofan and turbojet engines. The normalized rated power variable is not applicable in this case and is set to -99999. The bypass ratio is not a valid parameter for turboprop and piston engines. For these engines, the normalized bypass ratio is set to -999, and the normalized rated power variable is used to consider buoyancy. The negative values for the normalized thrust, rated power, and bypass ratio trigger activation of alternative workflows in the AERMOD plume rise algorithm.

When true airspeed is not available from the AEDT segment-level results, it is estimated using the segment's Mach number and air temperature (Eq. 13-8).

$$v_{a,s} = v_{0,mssl} \cdot M_{a,s} \cdot \sqrt{T_{a,s}/T_{mssl}} \quad \text{Eq. 13-8}$$

where:

$v_{a,s}$	Nominal true air speed for flight segment $s$ of the air operation $n$ in m/sec;
$M_{a,s}$	Nominal Mach number for the flight segment $s$ of the air operation $n$ ;
$T_{a,s}$	Temperature in Kelvin at the average altitude and time for the flight segment $s$ of the air operation $n$ ;
$v_{0,mssl}$	Speed of sound at mean sea level under International Standard Atmosphere (ISA) conditions in m/sec;
$T_{mssl}$	Temperature at mean sea level in Kelvin under ISA conditions.

Source angle ( $\theta$ ) in Table 13-8 is defined as a glancing angle with ground surface. Each segment's glancing angle,  $\theta_{a,s}$ , is calculated as follows:

$$\theta_{a,s} = \sin^{-1}(U_{z,a,s}) \quad \text{Eq. 13-9}$$

where  $U_{z,s}$  is a  $z$  component of the segment's unit directional vector,  $\vec{U}_s$ , in a three-dimensional cartesian plane.

The unit vector is calculated by AEDT for each flights' segments and is defined as follows:

$$\vec{U}_{a,s} = (U_{x,a,s}, U_{y,a,s}, U_{z,a,s}) \quad \text{Eq. 13-10}$$

The source angle for all helicopter sources is set to zero.

### 13.3.2 AERMOD.INP File Changes in Support of Plume Rise Modeling

This section describes changes in the AERMOD.INP file when plume rise modeling is enabled. In the CO pathway, the ALPHA modeling option is set because the new plume rise algorithm is implemented in AERMOD as an ALPHA option. In addition, the ARCFTOPT keyword is added to the CO pathway to instruct AERMOD that the input file contains aircraft sources that should incorporate plume rise. Figure 13-2 highlights these changes to the CO pathway.

```

CO STARTING
  TITLEONE Study [STUDY_PVD]; Job [4]; Pollutant [CO]
  TITLETWO User [MyWindowsAccount]; Version [AEDT 3f 208.0.19580.1]; Time [11/14/2023
11:10:20 AM]
  MODELOPT   CONC  ALPHA
  AVERTIME   1 PERIOD
  POLLUTID   CO
  FLAGPOLE   1.8
  RUNORNOT   RUN
  ARCFTOPT   STUDY_PVD
  SAVEFILE
CO FINISHED

SO STARTING
** ORIGIN: 41.7073858596759,   -71.4513821231799
  ELEVUNIT METERS
** -----
** SOURCE TYPE      AEDT SOURCE NAMES      AERMOD SOURCE NAMES
** -----
** GATE              AC                      GATE_001
** GATE              Cargo                    GATE_002
** GATE              GA                      GATE_003
** STATIONARY        10,000 Avgas-FuelTank  STAT_001
** STATIONARY        600kw Emer Gen #1     STAT_005
** STATIONARY        Boiler Terminal #1    STAT_007
** -----
**                SOURCE      TYPE      X(m)      Y(m)      Z(m)
** -----
  LOCATION  CUB000001  VOLUME  1614.37  2668.15  16.76
  LOCATION  CUB000002  VOLUME  1614.37  2648.15  16.76
  LOCATION  CUB000003  VOLUME  1634.37  2648.15  16.76
  LOCATION  CUB000004  VOLUME  1634.37  2628.15  16.76
  LOCATION  CUB000005  VOLUME  1654.37  2628.15  16.76

```

Figure 13-2 CO Pathway Changes

The ARCFTSRC keyword is added to the SO pathway which indicates which sources will be modeled with the aircraft plume rise algorithm. If aircraft plume rise is enabled when creating a metric result, the new source groups of TAKOFFGD, TAKOFFAR, CLIMBOUT, LNDNGGD, LNDNGAR, TAXIOUT, and TAXIIN are created and added to the INP file if there is at least one source in each of the respective source groups. These AERMOD source groups are uniquely mapped to the respective AEDT source groups which

are used to further delineate aircraft sources. The mappings between AEDT and AERMOD source groups are highlighted in Table 13-10.

Table 13-10 Aircraft Source Group Mapping and Options

AERMOD Source Group Definition	AEDT Source Group Definition	Optional in INP file when Plume Rise is Disabled	Optional in INP file when Plume Rise is Enabled	Can Model Plume Rise for Aircraft Sources
ALL	All	No	No	Yes
AIRCRAFT	Aircraft	No	No	Yes
AIRALL	Airborne	No	No	Yes
RUNWAY	Runway	No	No	Yes
TAXI	Taxiways	No	No	Yes
GATES	Gates	No	No	No
TAKOFFGD	Takeoff ground roll	Yes	No	Yes
TAKOFFAR	Takeoff airborne	Yes	No	Yes
CLIMBOUT	Climb-out	Yes	No	Yes
LNDNGGD	Landing ground roll	Yes	No	Yes
LNDNGAR	Airborne approach	Yes	No	Yes
TAXIIN	Taxi-in	Yes	No	Yes
TAXIOUT	Taxi-out	Yes	No	Yes
RUNUPPRE	Runup - Preflight Check	Yes	No	Yes
RUNUPTST	Runup - Engine Maintenance	Yes	No	Yes
OPGRP###	Operation Groups	Yes	Yes	Yes
FWJET FWTPROP FWPISTON RCTSHAFT RCPISTON	Engine type	Yes	Yes	Yes

Corresponding changes to the SO Pathway are illustrated in Figure 13-3.

```

** -----
** HOURLY EMISSION FILE:
** -----
HOUREMIS  STUDY_PVD_J4_CO.HRE  CUB000001-CUB000377
HOUREMIS  STUDY_PVD_J4_CO.HRE  GATE_001-GATE_003
HOUREMIS  STUDY_PVD_J4_CO.HRE  STAT_001
HOUREMIS  STUDY_PVD_J4_CO.HRE  STAT_005
HOUREMIS  STUDY_PVD_J4_CO.HRE  STAT_007
HOUREMIS  STUDY_PVD_J4_CO.HRE  TFJ00001-TFJ00070
** -----
** SOURCE GROUP DEFINITIONS:
** -----
ARCFTSRC  CUB000001-CUB000377  TFJ00001-TFJ00070
SRCGROUP  ALL
SRCGROUP  AIRCRAFT  CUB000001-CUB000377
SRCGROUP  AIRCRAFT  TFJ00001-TFJ00070
SRCGROUP  RUNWAY  CUB000001-CUB000099
    
```

```

SRCGROUP   RUNWAY   CUB000344-CUB000377
SRCGROUP   AIRALL   CUB000100-CUB000343
SRCGROUP   TAKOFFGD CUB000001-CUB000099
SRCGROUP   TAKOFFAR CUB000100-CUB000145
SRCGROUP   CLIMBOUT CUB000146-CUB000170
SRCGROUP   LNDNGGD  CUB000344-CUB000377
SRCGROUP   LNDNGAR  CUB000171-CUB000343
SRCGROUP   TAXI     TFJ00001-TFJ00070
SRCGROUP   TAXIOUT  TFJ00001-TFJ00040
SRCGROUP   TAXIIN   TFJ00041-TFJ00070
SRCGROUP   GATES    GATE_001-GATE_003
SRCGROUP   STATSRCS STAT_001
SRCGROUP   STATSRCS STAT_005
SRCGROUP   STATSRCS STAT_007
SO FINISHED

RE STARTING
ELEVUNIT METERS

```

Figure 13-3 SO Pathway Changes

AERMOD PLOTFILES are created only for the source groups which are selected by the user in the “Set Processing Options” dialog of the Define Metric Results wizard. Once generated, AERMOD PLOTFILES are stored in the AEDT database and are used to generate Emissions Dispersion reports and pollutant concentration layers and/or contours.

Figure 13-4 shows the PLOTFILES for the AERMOD source groups that were selected in the “Set Processing Options” dialog, which include All, Aircraft, Airborne, Taxiways, Runways, Gates, Stationary, Takeoff ground roll, Takeoff airborne, Climb-out, Airborne approach, Landing ground roll, Taxi-out, and Taxi-in.

```

OU STARTING
RECTABLE   ALLAVE   1
PLOTFILE   1   LNDNGAR   1   STUDY_PVD_J4_CO_ONE_1_LNDNGAR_NOBACK.PLT   10000
PLOTFILE   1   AIRCRAFT   1   STUDY_PVD_J4_CO_ONE_1_AIRCRAFT_NOBACK.PLT   10001
PLOTFILE   1   ALL       1   STUDY_PVD_J4_CO_ONE_1_ALL_NOBACK.PLT   10002
PLOTFILE   1   AIRALL   1   STUDY_PVD_J4_CO_ONE_1_AIRALL_NOBACK.PLT   10003
PLOTFILE   1   CLIMBOUT  1   STUDY_PVD_J4_CO_ONE_1_CLIMBOUT_NOBACK.PLT   10004
PLOTFILE   1   GATES    1   STUDY_PVD_J4_CO_ONE_1_GATES_NOBACK.PLT   10005
PLOTFILE   1   LNDNGGD  1   STUDY_PVD_J4_CO_ONE_1_LNDNGGD_NOBACK.PLT   10006
PLOTFILE   1   RUNWAY   1   STUDY_PVD_J4_CO_ONE_1_RUNWAY_NOBACK.PLT   10007
PLOTFILE   1   STATSRCS  1   STUDY_PVD_J4_CO_ONE_1_STATSRCS_NOBACK.PLT   10008
PLOTFILE   1   TAKOFFAR  1   STUDY_PVD_J4_CO_ONE_1_TAKOFFAR_NOBACK.PLT   10009
PLOTFILE   1   TAKOFFGD  1   STUDY_PVD_J4_CO_ONE_1_TAKOFFGD_NOBACK.PLT   10010
PLOTFILE   1   TAXIIN   1   STUDY_PVD_J4_CO_ONE_1_TAXIIN_NOBACK.PLT   10011
PLOTFILE   1   TAXIOUT  1   STUDY_PVD_J4_CO_ONE_1_TAXIOUT_NOBACK.PLT   10012
PLOTFILE   1   TAXI     1   STUDY_PVD_J4_CO_ONE_1_TAXI_NOBACK.PLT   10013
PLOTFILE   PERIOD   LNDNGAR   STUDY_PVD_J4_CO_PERIOD_LNDNGAR_NOBACK.PLT   10014
PLOTFILE   PERIOD   AIRCRAFT   STUDY_PVD_J4_CO_PERIOD_AIRCRAFT_NOBACK.PLT   10015
PLOTFILE   PERIOD   ALL       STUDY_PVD_J4_CO_PERIOD_ALL_NOBACK.PLT   10016
PLOTFILE   PERIOD   AIRALL   STUDY_PVD_J4_CO_PERIOD_AIRALL_NOBACK.PLT   10017
PLOTFILE   PERIOD   CLIMBOUT  STUDY_PVD_J4_CO_PERIOD_CLIMBOUT_NOBACK.PLT   10018
PLOTFILE   PERIOD   GATES    STUDY_PVD_J4_CO_PERIOD_GATES_NOBACK.PLT   10019
PLOTFILE   PERIOD   LNDNGGD  STUDY_PVD_J4_CO_PERIOD_LNDNGGD_NOBACK.PLT   10020
PLOTFILE   PERIOD   RUNWAY   STUDY_PVD_J4_CO_PERIOD_RUNWAY_NOBACK.PLT   10021

```



```
PLOTFILE PERIOD STATSRCS STUDY_PVD_J4_CO_PERIOD_STATSRCS_NOBACK.PLT 10022
PLOTFILE PERIOD TAKOFFAR STUDY_PVD_J4_CO_PERIOD_TAKOFFAR_NOBACK.PLT 10023
PLOTFILE PERIOD TAKOFFGD STUDY_PVD_J4_CO_PERIOD_TAKOFFGD_NOBACK.PLT 10024
PLOTFILE PERIOD TAXIIN STUDY_PVD_J4_CO_PERIOD_TAXIIN_NOBACK.PLT 10025
PLOTFILE PERIOD TAXIOUT STUDY_PVD_J4_CO_PERIOD_TAXIOUT_NOBACK.PLT 10026
PLOTFILE PERIOD TAXI STUDY_PVD_J4_CO_PERIOD_TAXI_NOBACK.PLT 10027
FILEFORM EXP
OU FINISHED
```

Figure 13-4 AERMOD PLOTFILES

## 14. Appendix – Example of GSE Population Emissions Calculation

The following example helps illustrate how AEDT calculates GSE population emissions when GSE’s manufacture year is not specified (refer to Section 5.2.1 GSE Population Processing Algorithm). In this example, a user would like to calculate CO emissions for a “Diesel - Stewart & Stevenson TUG GT-35, MC - Aircraft Tractor” over a two-week period in 2019.

- GSE: “Diesel - Stewart & Stevenson TUG GT-35, MC - Aircraft Tractor” which is a Diesel fuel type, Aircraft Tractor
  - Horsepower: 124 hp
  - Load factor: 0.8
- Annual hours of operation: 800 (user-provided value)
- Number of GSE units: 20 (user-provided value)
- Manufacture year: not specified
- Analysis date range: February 24 - March 9, 2019

To calculate total annual hours-of-operation weight ( $W_g$ ) from Eq. 5-21, 2019 operational profiles for this GSE population are required. Table 14-1 provides the 2019 operational profiles used for this example.

Table 14-1 2019 Operational Profiles for Example GSE Population Emissions Calculation

Profile Type	Description	Weight	Profile Type	Description	Weight
Monthly	Jan, Feb, Dec	0.25	Quarter-Hourly	00:00 to 05:00	0.10
Monthly	Mar, Apr, May	0.50	Quarter-Hourly	05:00 to 09:00	0.50
Monthly	Jun, Jul, Aug	1.00	Quarter-Hourly	09:00 to 11:00	1.00
Monthly	Sep, Oct, Nov	0.50	Quarter-Hourly	11:00 to 15:00	0.75
Daily	Sun, Thu	0.75	Quarter-Hourly	15:00 to 19:00	1.00
Daily	Mon, Fri, Sat	1.00	Quarter-Hourly	19:00 to 22:00	0.50
Daily	Tue, Wed	0.50	Quarter-Hourly	22:00 to 00:00	0.10

AEDT calculates hourly profiles from quarter-hourly profiles by summing up the weights of four quarters within the hour.

In order to calculate emissions dispersion of a particular GSE population, hourly emissions (HRE) need be produced. Using Eq. 5-20 for January 1, 2019 of the 6<sup>th</sup> hour (i.e. 5 am), the weight is:

$$W_{g,1,6} = 0.25 * 0.50 * 2.00 = 0.25$$

where:

0.25 is the weight for the month (January);

0.50 is the weight for day of the week (Tuesday for 2019); and

2.00 is the 6<sup>th</sup> hour weight (calculated by adding up the weight of four quarter-hours in the 6<sup>th</sup> hour, 0.50 + 0.50 + 0.50 + 0.50).

AEDT pre-calculates weights per hour for the entire year using the same method and maintains this data as a dictionary of key-value pair where key is Date Time and value is weight per hour. In order to calculate emissions dispersion of a particular GSE population, hourly emissions (HRE) need to be produced. Using the annual hours of operation (i.e., 800), the peak quarter-hour operations (*PeakOps<sub>q,g</sub>*) are then calculated from Eq. 5-21.

$$PeakOpHrs_{q,g} = \frac{AnnOpsHrs}{W_g} = \frac{800}{8553.60} = 0.093528$$

where  $W_g$  is the sum of all operation weights.

The operation per hour for the 6<sup>th</sup> hour of January 1, 2019 is given by:

$$OpsHrs_{g,1,6} = PeakOpHrs_{s,g} * W_{g,1,6} = 0.093528 * 0.25 = 0.023382$$

The emission for this hour is obtained by:

$$OpsHrs_{g,1,6} * EmissionPerHour$$

For the entire day:

$$W_{g,Julian\ Day\ 1} = 0.25 * 0.50 * 52.80$$

where 52.80 is the summed total of all hourly weights (or quarter-hourly weights). Each additional Julian day needs to be calculated in the same way, then the results from all 365 Julian days (366 in a leap year) are added together to obtain the total operations weighting ( $W_g$ ). For this example,  $W_g$  equals 8,553.60. Using the annual hours of operation (i.e., 800), the peak quarter-hour operations (*PeakOps<sub>q,g</sub>*) are then calculated from Eq. 5-21, which equals 0.093528. Total operations for the modeling period (*TotOps<sub>g</sub>*) is calculated from Eq. 5-23.

Table 14-2 Calculated Daily Weights for Two-Week Modeling Period

Start-of-Week Date	Sunday	Monday	Tuesday	Wednesday	Thursday	Friday	Saturday
<b>Feb 24</b>	9.9	13.2	6.6	6.6	9.9	26.4	26.4
<b>Mar 3</b>	19.8	26.4	13.2	13.2	19.8	26.4	26.4

The sum of the weights from Table 14-2 multiplied by the *PeakOps<sub>q,g</sub>* calculated previously gives the *TotOps<sub>g</sub>* for the modeling period. In this example, *TotOps<sub>g</sub>* equals 22.8395 (the week of Feb 24 is 9.2592, and the week of Mar 3 is 13.58024).

Finally, total GSE population emissions is calculated using Eq. 5-24. Since the manufacture year of GSE is not specified in this example, emission factors from the `StnGseEmissionFactorNationalAverage` table are used and a deterioration calculation is not performed. The CO emission factor for a Diesel fuel type, Aircraft Tractor for analysis year 2019 is 0.14999 g/hp-hr.

The rated power for this GSE population is 124 hp; and load factor is 0.8. The number of GSE units is 20. The total mass of CO emitted in this example ( $m_{CO,GT35}$ ) is thus:

$$m_{CO,GT35} = (0.14999 * 124 * 0.8 * 20) * 22.84$$

where  $m_{CO,GT35}$  equals 6,796.73 g.

## 15. Appendix – Map Projection Method

The mapping of latitude-longitude coordinates to and from x,y coordinates is accomplished by projecting a small portion of the earth's surface onto a cone. The transformation equations are outlined below.

Let  $A = 6378137.000$  m = radius of the equator circle (WGS-84 spheroid);  
 $B = 6356752.314$  m = distance from earth center to a pole (WGS-84 spheroid);  
 $\phi_0 \lambda_0$  = latitude and longitude of the origin of the x,y coordinate system (radians);  
 $\phi \lambda$  = latitude and longitude of a point on the earth (radians,  $180/\pi$  degrees/radian); and  
 $x y$  = coordinate values of the same point (meters, 1852 m/nmi).

North latitude is positive and south latitude is negative. East longitude is positive and west longitude is negative. Positive x is toward the east, and positive y is toward the north.

The two principal radii of curvature at latitude  $\phi_0$  are:

$$R_p = A^2 / \sqrt{A^2 \cos^2 \phi_0 + B^2 \sin^2 \phi_0}; \text{ and}$$

$$R_m = R_p^3 B^2 / A^4.$$

where

$R_p$  = radius of curvature (m) in a plane perpendicular to a meridian plane; and  
 $R_m$  = radius of curvature (m) in a meridian plane.

A cone is constructed with its vertex on the line of poles, tangent to the earth spheroid along a latitude circle at  $\phi_0$ . The cone is cut from edge to vertex and unfolded so that it lies flat. An x,y coordinate system is constructed on the unfolded cone. The x-axis is tangent to the latitude circle at  $\phi_0$ , and the y-axis is tangent to the longitude ellipse at  $\lambda_0$ .

For conic projections, latitude circles (parallels) map into circles centered on the vertex of the unfolded cone, and longitude ellipses (meridians) map into straight lines that converge at the vertex of the unfolded cone.

For points on the y-axis, the y-coordinate is accurately approximated by the meridian arc-distance:

$$x = 0; \text{ and}$$

$$y = R_m (\phi - \phi_0).$$

For points off the y-axis, the y = constant coordinates lie on a conic circle centered at the vertex of the unfolded cone. For this case, the x-coordinate is approximated by the arc-distance along a conic circle; and the y-coordinate is approximated by the y-value at x=0 plus a parabolic correction:

$$x = (R_p \cos \phi_0 - y_0 \sin \phi_0)(\lambda - \lambda_0) \quad \text{Eq. 15-1}$$

$$y = y_0 + E_0 x^2$$

where

$y_0 = R_m (\phi - \phi_0)$ ; and

$$E_o = \frac{1}{2} \tan \phi_o / R_p.$$

An exact inverse transformation is provided by the following equations:

$$\begin{aligned} \phi &= \phi_o + y_o / R_m \\ \lambda &= \lambda_o + x / (R_p \cos \phi_o - y_o \sin \phi_o) \end{aligned} \quad \text{Eq. 15-2}$$

where

$$y_o = y - E_o x^2.$$

The above conic projection method provides a simple and very quick transformation between latitude-longitude and x,y coordinates. (The radii of curvature  $R_p$ ,  $R_m$ , the sine and cosine terms  $\cos \phi_o$ ,  $\sin \phi_o$ , and the off-axis correction coefficient  $E_o$  are constants that are calculated only once.) A computationally quick transformation is required because lat/long values are calculated and displayed for every movement of the mouse pointer when in lat/long mode in a graphics window.

The conic projection method is not exactly conformal (angles on the earth do not exactly map into the same angles in the x,y coordinate system). However, the method is very accurate within an area of approximately one hundred miles around the origin of coordinates.

For example, if the origin is at 45°N 90°E, a 1-km square on the earth's surface located at 46°N 91°E (about 73 nmi from the origin), when mapped into x,y coordinates, is 23 cm longer in the east-west direction and 25 cm shorter in the north-south direction. By comparison, the same 1-km square mapped by the standard Mercator projection method is 1786 cm larger in both directions.

---

## 16. References

1. Ross, Jason, et al., Aviation Environmental Design Tool (AEDT) User Manual Version 3g, Report No. DOT-VNTSC-FAA-24-09, Washington, D.C.: Federal Aviation Administration, August 2024.
2. SAE International, Committee A-21, Aircraft Noise, Standard Values of Atmospheric Absorption as a Function of Temperature and Humidity, Aerospace Research Report No. 866A, Warrendale, PA: SAE International, March 1975.
3. SAE International, Committee A-21, Aircraft Noise, Procedure for the Calculation of Airplane Noise in the Vicinity of Airports, Aerospace Research Report No. 1845, Warrendale, PA: SAE International, September 1995.
4. SAE International, Committee A-21, Aircraft Noise, Application of Pure-Tone Atmospheric Absorption Losses to One-Third Octave-Band Data, Aerospace Research Report No. 5534, Warrendale, PA: SAE International, August 2013.
5. SAE International, Committee A-21 Aircraft Noise Measurement Aviation Emission Modeling, Fuel Flow Rates for Jet-Powered Commercial Aircraft Taxi Operations, Aerospace Information Report No. 8035, Warrendale, PA: SAE International, April 2023.
6. SAE International, Committee A-21 Aircraft Noise Measurement Aviation Emission Modeling, Procedures for the Calculation of Airplane Fuel Consumption, Aerospace Research Report No. 6183, Warrendale, PA: SAE International, September 2022.
7. International Civil Aviation Organization (ICAO), Manual of the ICAO Standard Atmosphere, Doc 7488/3, 1993.
8. Preferred Frequencies, Frequency Levels and Band Numbers for Acoustical Measurements, American National Standard, ANSI S1.6-1984 (R2006), New York, NY: American National Standards Institute, 2006.
9. Specification for Octave-Band and Fractional-Octave-Band Analog and Digital Filters, American National Standard, ANSI S1.11-2004, New York, NY: American National Standards Institute, 2004.
10. AEDT Development Team, AEDT Database Description Document Study Database for AEDT 3g, August 2024.
11. AEDT Development Team, AEDT Database Description Document Airport Database for AEDT 3g, August 2024.
12. International Civil Aviation Organization (ICAO), ICAO Aircraft Engine Emissions Databank, <https://www.easa.europa.eu/domains/environment/icao-aircraft-engine-emissions-databank>, June 2023.
13. EUROCONTROL Experimental Center (EEC), ANP Database v2.3, <http://www.aircraftnoisemodel.org/>, October 2020.
14. EUROCONTROL Experimental Center (EEC), User Manual for the Base of Aircraft Data (BADA), Revision 4.2.
15. International Civil Aviation Organization (ICAO) Document 8643, 40<sup>th</sup> ed., <http://www.icao.int/publications/DOC8643/Pages/Doc8643.aspx>, 2011.
16. IATA Airline code search, <https://www.iata.org/en/publications/directories/code-search/>, 2011.
17. AEDT Development Team, AEDT Database Description Document Fleet Database for AEDT 3g, August 2024.
18. Spectral Classes For FAA's Integrated Noise Model, Report No. DTS-34-FA065-LR1, Cambridge, MA, John A. Volpe National Transportation Systems Center, December 1999.

19. Bishop, D. E., et al., Revision of Civil Aircraft Noise Data for the Integrated Noise Model (INM), Report No. 6039, Canoga Park, CA: BBN Laboratories Incorporated, September 1986.
20. EUROCONTROL, Eurocontrol Experimental Center (EEC). Base of Aircraft Data (BADA), Revision 3.16.
21. Senzig, D., et al., Fuel Consumption Modeling in Support of ATM Environmental Decision-Making. Joint Meeting of FAA and EUROCONTROL on Air Traffic Management, Napa, California, June 25-29, 2009.
22. Senzig, et al., Modeling of Terminal-Area Airplane Fuel Consumption, Journal of Aircraft, Vol. 46, No. 4, July-August 2009, pp 1089-1093.
23. Eldred, Kenneth M. and Robert L. Miller. Analysis of Selected Topics in the Methodology of the Integrated Noise Model, November 1980, DOT-TSC-1782.
24. Ross, Jason, et al., AEDT Supplemental Manual: ASIF Reference, Washington, D.C.: Federal Aviation Administration, December 2023.
25. Senzig, et al., AEDT sensor path methods using BADA4, Report No. DOT-VNTSC-FAA-17-13, Washington, D.C.: Federal Aviation Administration, June 2017.
26. Code of Federal Regulations, Title 14: Aeronautics and Space, Part 36, Noise Standards: Aircraft Type and Airworthiness Certification (14 CFR Part 36), Washington, D.C.: Federal Aviation Administration, September 1992.
27. SAE International, Committee A-21, Aircraft Noise, Method for Predicting Lateral Attenuation of Airplane Noise, Aerospace Information Report No. 5662, Warrendale, PA: SAE International, April 2006.
28. Moulton, C.L., Air Force Procedure for Predicting Aircraft Noise Around Airbases: Noise Exposure Model (NOISEMAP), User's Manual, Report No. AAMRL-TR-90-011, Wright- Patterson Air Force Base, Ohio: United States Air Force, February 1990.
29. SAE International, Method for Modeling Line-of-Sight Blockage of Aircraft Noise (AIR6501), Report No. 6501, February 2020.
30. Barry, T.M. et al, FHWA Highway Traffic Noise Prediction Model, Appendix B, FHWA-RD-77-108, Washington, D.C., 1978.
31. Fleming, et al., Assessment of Tools for Modeling Aircraft Noise in the National Parks, FICAN report, Cambridge, MA: John A. Volpe National Transportation Systems Center, Arlington, VA: Wyle Laboratories, Winchester, MA: Senzig Engineering, March 2005.
32. Sutherland, et al., Atmospheric Sound Propagation, Encyclopedia of Acoustics, Vol. 1, 1979, p. 351 – 353.
33. Noel, George, et al., Thrust Reverser Analysis for Implementation in Aviation Environmental Development Tool (AEDT), RTV-4F-FA4T-LR1; PB2007-111124, Cambridge, MA: John A. Volpe National Transportation Systems Center, June 2007.
34. SAE International, Committee A-21, Aircraft Noise, Method to Calculate Behind Start of Takeoff Roll Noise Level Adjustments, Aerospace Information Report No. 6297, Warrendale, PA: SAE International, July 2017.
35. Rickley, Ed, et al., Noise Measurement Flight Test of Five Light Helicopters. Report No. DOT-VNTSC-FAA-93-5, Cambridge, MA: John A. Volpe National Transportation Systems Center, July 1993.
36. Boeker, Eric, et. Al., Analysis of Modeling Cumulative Noise from Simultaneous Flights; Volume 1: Analysis at Four National Parks, Report No. DOT-VNTSC-FAA-12-08.I, DOT-FAA-AEE-2012-07, December 2012. <https://rosap.ntl.bts.gov/view/dot/9702>.
37. DuBois, Douglass, et al., Fuel Flow Method for Estimating Aircraft Emissions, SAE Technical Papers,



- Warrendale, Pa, 2006.
38. Ahrens, D, Méry, Y, Guénard, A, & Miake-Lye, RC. "A New Approach to Estimate Particulate Matter Emissions From Ground Certification Data: The nvPM Mission Emissions Estimation Methodology (MEEM)." *Proceedings of the ASME Turbo Expo 2022: Turbomachinery Technical Conference and Exposition. Volume 3A: Combustion, Fuels, and Emissions*. Rotterdam, Netherlands. June 13–17, 2022. V03AT04A035. ASME. <https://doi.org/10.1115/GT2022-81277>.
  39. Emissions and Dispersion and Modeling System (EDMS) User's Manual Version 5.1.4, Document FA-AEE-07-01 (Rev. 10), prepared for the Federal Aviation Administration, Office of Environment and Energy, by CSSI, Inc., Washington, D.C., June 2013.
  40. International Civil Aviation Organization (ICAO), Airport Air Quality Manual (Doc 9889) CAEP10 Steering Group 2015 Approved Revision, <https://www.icao.int/environmental-protection/Documents/Doc%209889.SGAR.WG2.Initial%20Update.pdf>, Montreal, Quebec, Canada, 2015.
  41. Hadaller, O. J., and A. M. Momenty. The Characteristics of Future Fuels. Boeing publication D6-54940, 1989.
  42. Hadaller, O. J., and A. M. Momenty. Characteristics of Future Aviation Fuels. Chapter 10 in *Transportation and Global Climate Change*, (D. L. Greene and D. J. Santini, Eds.). American Council for an Energy-Efficient Economy. Washington, DC., 1993.
  43. U.S. EPA and FAA, Recommended Best Practice for Quantifying Speciated Organic Gas Emissions from Aircraft Equipped with Turbofan, Turbojet, and Turboprop Engines Version 1.0. FAA AEE, USEPA Assessment and Standards Division, Office of Transportation and Air Quality. Report No. EPA-420-R-09-901. May 27, 2009.
  44. KB Environmental Sciences, Inc. and Aerodyne Research, Inc., Quality Assurance Project Plan for the Development of a Commercial Aircraft Hazardous Air Pollutants Emissions Inventory Methodology, Environmental Protection Agency and the Federal Aviation Administration, Washington D.C., March 2008.
  45. FAA and U.S. EPA: Technical Data to Support FAA's Advisory Circular on Reducing Emissions from Commercial Aviation, September 1995.
  46. U.S. EPA, Fuel Supply Defaults, Regional Fuels and the Fuel Wizard in MOVES4, Report No. EPA-420-R-23-025, August 2023.
  47. U.S. EPA, Exhaust and Crankcase Emission Factors for Nonroad Compression-Ignition Engines in MOVES3.0.2. Report No. EPA-420-R-21-021, September, 2021.
  48. U.S. EPA, Conversion Factors for Hydrocarbon Emission Components, NR-002d. Report No. EPA-420-R-10-015, July 2010.
  49. FAA, Guidance for Quantifying Speciated Organic Gas Emissions from Airport Sources, Version 1. Report No. EPA-420-R-09-901, September 2, 2009.
  50. U.S. EPA, User's Guide for the AMS/EPA Regulatory Model (AERMOD), EPA-454/B-23-008, Office of Air Quality Planning and Standards, Air Quality Assessment Division, Research Triangle Park, North Carolina, October 2023.
  51. AEDT Documentation, AEDT Supplemental Manual: Using MOVES with AEDT, <https://aedt.faa.gov>, December 2023.
  52. Emissions and Dispersion and Modeling System (EDMS) Technical Manual Version 5.0, Document FA-AEE-07-07, prepared for the Federal Aviation Administration, Office of Environment and Energy, by CSSI, Inc., Washington, DC, November 2010.

53. AEDT Documentation, AEDT Supplemental Manual: Background Concentrations in AEDT, <https://aedt.faa.gov>, December 2023.
54. U.S. EPA, User's Guide for the AERMOD Meteorological Preprocessor (AERMET), EPA-454/B-23-005, Office of Air Quality Planning and Standards, Air Quality Assessment Division, Research Triangle Park, North Carolina, October 2023.
55. U.S. EPA, Clarification Memorandum - Use of ASOS Meteorological Data in AERMOD Dispersion Modeling, March 8, 2013.
56. U.S. EPA, AERMINUTE User's Guide, EPA 454/B-23-007, Office of Air Quality Planning and Standards, Air Quality Assessment Division, Research Triangle Park, North Carolina, October 2023.
57. Harris, C. M. (ed.), Handbook of Acoustical Measurements and Noise Control, Third Edition, New York, NY: McGraw-Hill, 1991.
58. Beranek, L. L., (ed.), Noise and Vibration Control, Revised Edition, New York, NY: McGraw-Hill, 1988.
59. Eldred, K. M., Approximating Aircraft Noise Using a Model of a Moving Source with a 90° Dipole Radiation Pattern, Memorandum to Dr. R. G. Gados, The Mitre Corporation, Cambridge, MA: Bolt Beranek and Newman, Inc., March 1980.
60. Olmstead, J., INM 6.0 Exposure Fraction Algorithm, Memorandum to John Guidling, ATAC Corporation, Sunnyvale, CA, December 14, 1998.
61. Committee on Aircraft Noise (CAN): *Seventh Meeting Report on Agenda Item 3*. ICAO CAN/7-WP/59, May 1983. (Referring to: ICAO CAN/7-WP/19: *A revision to the definition of the reference atmosphere in Annex 16 to improve data quality and reliability and ease technical problems*), March 1983.
62. Green, David M. and Swets, John A., Signal Detection Theory and Psychophysics, New York: John Wiley and Sons, Inc, 1966.
63. Fidell, et al., Predicting Annoyance from Detectability of Low-Level Sounds, Journal of the Acoustical Society of America, 66(5), November 1979, p. 1427 – 1434.
64. Horonjeff, Richard D., Comparison of ISO Human Threshold of Hearing Standards: ISO R226:1961 and ISO 389-7:1998, Plus Equivalent Auditory System Noise (EASN) 1/3 Octave Band Spectra Therefrom Derived, Plus Modified FORTRAN Implementation of d'Algorithm Using EASN in Place of Threshold of Hearing, December 7, 2004.
65. International Civil Aviation Organization (ICAO), Environmental Protection, Annex 16, Volume 1, Aircraft Noise. Fourth Edition - 2005. (Amendment 8, Applicable 24 November, 2005).
66. Bishop, D. E., Beckmann, J. M., Bucka, M. P., Revision of Civil Aircraft Acoustic data for the Integrated Noise Model (INM), Report No. 6039, Canoga Park, CA: BBN Laboratories Incorporated, September 1986.
67. International Civil Aviation Organization (ICAO), Recommended Method for Computing Noise Contours around Airports, Doc 9911, Second Edition, 2018.
68. Airport Activity Statistics of Certificated Air Carriers, Washington, D.C.: U.S. Department of Transportation Statistics, Office of Airline Information, December 1995.
69. Aerospace Source Book, Aviation Week & Space Technology, McGraw-Hill Companies, January 12, 1998.
70. European Civil Aviation Conference (ECAC), Report of Standard Method of Computing Noise Contours around Civil Airports, ECAC.CEAC Doc 29, Fourth Edition, 2016.
71. Embleton, Tony F.W., Piercy, Joe E., Daigle, Giles A., Effective Flow Resistivity of Ground Surfaces Determined by Acoustical Measurements, J. Acoust. Soc. Am. Vol. 74, No. 4, pp 1239-1243, 1983.

72. U.S. EPA, Compilation of Air Pollutant Emission Factors, Volume I: Stationary Point and Area Sources, EPA Report No. AP-42, January 1995.
73. U.S. EPA, Procedures for Emission Inventory Preparation, Volume IV: Mobile Sources. EPA-420-R-92-009, December 1992.
74. Jagielski, Kurt D., and O'Brien, Robert J., Calculation Methods for Criteria Air Pollutant Emission Inventories, USAF Occupational and Environmental Health Directorate, Air Force Material Command, Brooks AFB, Texas, July 1994.